

## Dual Ultra-Low Power Op Amp in SOT-23-8

### Features

- 8-Pin SOT-23 Package
- 3 MHz Gain-Bandwidth Product
- 5 MHz, -3 dB Bandwidth
- 31  $\mu$ A Supply Current
- Rail-to-Rail Output
- Ground Sensing at Input (Common-Mode-to-GND)
- Drives Large Capacitive Loads
- Unity Gain Stable

### Applications

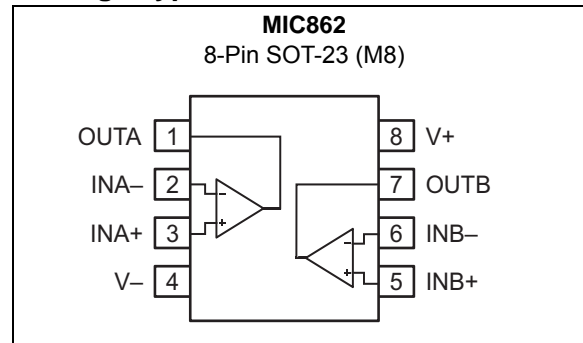
- Portable Equipment
- Medical Instruments
- PDAs
- Pagers
- Cordless Phones
- Consumer Electronics

### General Description

The MIC862 is a dual low-power operational amplifier in an SOT23-8 package. It is designed to operate in the 2V to 5V range, rail-to-rail output, with input common-mode to ground. The MIC862 provides 3 MHz gain-bandwidth product while consuming only 31  $\mu$ A supply current per channel.

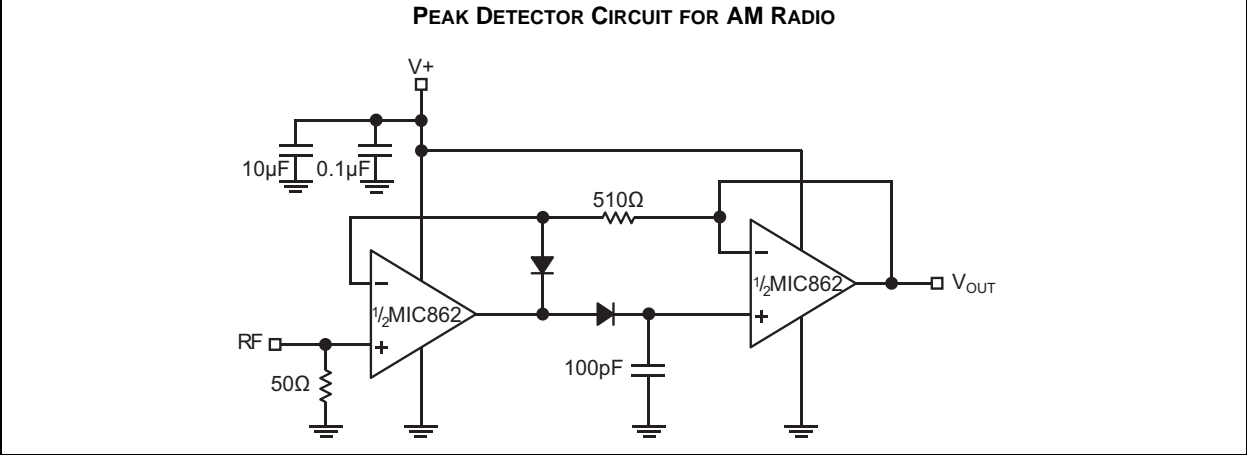
With low supply voltage and 8-lead SOT-23 packaging, MIC862 provides two channels as general-purpose amplifiers for portable and battery-powered applications. Its package provides the maximum performance available while maintaining an extremely slim form factor. The minimal power consumption of this IC maximizes the battery life potential.

### Package Type



# MIC862

## Typical Application Schematic



## 1.0 ELECTRICAL CHARACTERISTICS

### Absolute Maximum Ratings †

Supply Voltage ( $V_{V+}$ to $V_{V-}$ ).....	+6.0V
Differential Input Voltage ( $V_{IN+}$ to $V_{IN-}$ ) (Note 1).....	+6.0V
Input Voltage ( $V_{IN+}$ to $V_{IN-}$ ).....	$V_{V+} + 0.3V$ , $V_{V-} - 0.3V$
Output Short-Circuit Current Duration.....	Indefinite
ESD Rating (Note 2).....	ESD Sensitive

### Operating Ratings ‡

Supply Voltage ( $V+$ to $V-$ ).....	+2.0V to +5.25V
--------------------------------------	-----------------

† **Notice:** Stresses above those listed under “Absolute Maximum Ratings” may cause permanent damage to the device. This is a stress rating only and functional operation of the device at those or any other conditions above those indicated in the operational sections of this specification is not intended. Exposure to maximum rating conditions for extended periods may affect device reliability.

‡ **Notice:** The device is not guaranteed to function outside the operating ratings.

**Note 1:** Exceeding the maximum differential input voltage will damage the input stage and degrade performance (in particular, input bias current is likely to increase).

**2:** Devices are ESD sensitive. Handling precautions are recommended. Human body model, 1.5 k $\Omega$  in series with 100 pF.

# MIC862

**TABLE 1-1: ELECTRICAL CHARACTERISTICS**

Electrical Characteristics: $V_+ = +2V$ , $V_- = 0V$ , $V_{CM} = V_+/2$ ; $R_L = 500\text{ k}\Omega$ to $V_+/2$ ; $-40^\circ\text{C} \leq T_A \leq +85^\circ\text{C}$ unless otherwise noted.						
Parameters	Symbol	Min.	Typ.	Max.	Units	Conditions
Input Offset Voltage	$V_{OS}$	-6	0.1	6	mV	—
		-5	0.1	5		$T_A = +25^\circ\text{C}$
		—	0.5	—	mV	—
Differential Offset Voltage	$V_{OS}$	—	0.5	—	mV	—
Input Offset Voltage Temperature Coefficient		—	6	—	$\mu\text{V}/^\circ\text{C}$	—
Input Bias Current	$I_B$	—	10	—	pA	—
Input Offset Current	$I_{OS}$	—	5	—	pA	—
Input Voltage Range (from $V_-$ )	$V_{CM}$	0.5	1	—	V	CMRR > 50 dB
Common-Mode Rejection Ratio	CMRR	45	75	—	dB	$0V < V_{CM} < 1V$
Power Supply Rejection Ratio	PSRR	50	78	—	dB	Supply voltage change of 2V to 2.7V.
Large-Signal Voltage Gain	$A_{VOL}$	66	74	—	dB	$R_L = 5\text{ k}\Omega$ , $V_{OUT} = 1.4\text{ V}_{PP}$
		75	89	—		$R_L = 100\text{ k}\Omega$ , $V_{OUT} = 1.4\text{ V}_{PP}$
		85	100	—		$R_L = 500\text{ k}\Omega$ , $V_{OUT} = 1.4\text{ V}_{PP}$
Maximum Output Voltage Swing	$V_{OUT}$	$V_+ - 80\text{ mV}$	$V_+ - 55\text{ mV}$	—	V	$R_L = 5\text{ k}\Omega$
		$V_+ - 3\text{ mV}$	$V_+ - 1.4\text{ mV}$	—	V	$R_L = 500\text{ k}\Omega$
Minimum Output Voltage Swing	$V_{OUT}$	—	$V_- + 14\text{ mV}$	$V_- + 20\text{ mV}$	V	$R_L = 5\text{ k}\Omega$
		—	$V_- + 0.85\text{ mV}$	$V_- + 3\text{ mV}$	V	$R_L = 500\text{ k}\Omega$
Gain-Bandwidth Product	GBW	—	2.1	—	MHz	$R_L = 20\text{ k}\Omega$ , $C_L = 2\text{ pF}$ , $A_V = 11$
Phase Margin	PM	—	57	—	°	$R_L = 20\text{ k}\Omega$ , $C_L = 2\text{ pF}$ , $A_V = 11$
-3 dB Bandwidth	BW	—	4.2	—	MHz	$R_L = 1\text{ M}\Omega$ , $C_L = 2\text{ pF}$ , $A_V = 1$
Slew Rate	SR	—	2	—	V/ $\mu\text{s}$	$R_L = 1\text{ M}\Omega$ , $C_L = 2\text{ pF}$ , $A_V = 1$ , Positive Slew Rate = 1.5 V/ $\mu\text{s}$
Short-Circuit Output Current	$I_{SC}$	1.8	2.6	—	mA	Source
		1.5	2.2	—		Sink
Supply Current (per Op Amp)	$I_S$	—	27	43	$\mu\text{A}$	No Load
Channel-to-Channel Crosstalk	—	—	-100	—	dB	Note 1

**Note 1:** DC signal referenced to input. Refer to the [Typical Performance Curves](#) section's AC performance graphs.

**TABLE 1-2: ELECTRICAL CHARACTERISTICS**

**Electrical Characteristics:**  $V_+ = +2.7V$ ,  $V_- = 0V$ ,  $V_{CM} = V_+/2$ ;  $R_L = 500\text{ k}\Omega$  to  $V_+/2$ ;  $-40^\circ\text{C} \leq T_A \leq +85^\circ\text{C}$  unless otherwise noted.

Parameters	Symbol	Min.	Typ.	Max.	Units	Conditions
Input Offset Voltage	$V_{OS}$	-6	0.1	6	mV	—
		-5	0.1	5		$T_A = +25^\circ\text{C}$
Differential Offset Voltage		—	0.5	—	mV	—
Input Offset Voltage Temperature Coefficient		—	6	—	$\mu\text{V}/^\circ\text{C}$	—
Input Bias Current	$I_B$	—	10	—	pA	—
Input Offset Current	$I_{OS}$	—	5	—	pA	—
Input Voltage Range (from $V_-$ )	$V_{CM}$	1	1.8	—	V	CMRR > 60 dB
Common-Mode Rejection Ratio	CMRR	65	83	—	dB	$0V < V_{CM} < 1.35V$
Power Supply Rejection Ratio	PSRR	60	85	—	dB	Supply voltage change of 2.7V to 3V
Large-Signal Voltage Gain	$A_{VOL}$	65	77	—	dB	$R_L = 5\text{ k}\Omega$ , $V_{OUT} = 2 V_{PP}$
		80	90	—		$R_L = 100\text{ k}\Omega$ , $V_{OUT} = 2 V_{PP}$
		90	101	—		$R_L = 500\text{ k}\Omega$ , $V_{OUT} = 2 V_{PP}$
Gain-Bandwidth Product	GBW	—	2.3	—	MHz	$R_L = 20\text{ k}\Omega$ , $C_L = 2\text{ pF}$ , $A_V = 11$
Phase Margin	PM	—	50	—	°	$R_L = 20\text{ k}\Omega$ , $C_L = 2\text{ pF}$ , $A_V = 11$
-3 dB Bandwidth	BW	—	4.2	—	MHz	$R_L = 1\text{ M}\Omega$ , $C_L = 2\text{ pF}$ , $A_V = 1$
Slew Rate	SR	—	3	—	V/ $\mu\text{s}$	$R_L = 1\text{ M}\Omega$ , $C_L = 2\text{ pF}$ , $A_V = 1$ , Positive Slew Rate = 1.5 V/ $\mu\text{s}$
Short-Circuit Output Current	$I_{SC}$	4.5	6.3	—	mA	Source
		4.5	6.2	—		Sink
Supply Current (per Op Amp)	$I_S$	—	28	45	$\mu\text{A}$	No Load
Channel-to-Channel Crosstalk	—	—	-120	—	dB	Note 1

**Note 1:** DC signal referenced to input. Refer to the [Typical Performance Curves](#) section's AC performance graphs.

# MIC862

**TABLE 1-3: ELECTRICAL CHARACTERISTICS**

Electrical Characteristics: $V_+ = +5V$ , $V_- = 0V$ , $V_{CM} = V_+/2$ ; $R_L = 500\text{ k}\Omega$ to $V_+/2$ ; $-40^\circ\text{C} \leq T_A \leq +85^\circ\text{C}$ unless otherwise noted.						
Parameters	Symbol	Min.	Typ.	Max.	Units	Conditions
Input Offset Voltage	$V_{OS}$	-6	0.1	6	mV	—
		-5	0.1	5		$T_A = +25^\circ\text{C}$
Differential Offset Voltage		—	0.5	—	mV	—
Input Offset Voltage Temperature Coefficient		—	6	—	$\mu\text{V}/^\circ\text{C}$	—
Input Bias Current	$I_B$	—	10	—	pA	—
Input Offset Current	$I_{OS}$	—	5	—	pA	—
Input Voltage Range (from $V_-$ )	$V_{CM}$	3.5	4.1	—	V	CMRR > 60 dB
Common-Mode Rejection Ratio	CMRR	60	87	—	dB	$0V < V_{CM} < 3.5V$
Power Supply Rejection Ratio	PSRR	60	92	—	dB	Supply voltage change of 3V to 5V
Large-Signal Voltage Range	$A_{VOL}$	65	73	—	dB	$R_L = 5\text{ k}\Omega$ , $V_{OUT} = 4.8\text{ V}_{PP}$
		80	86	—		$R_L = 100\text{ k}\Omega$ , $V_{OUT} = 4.8\text{ V}_{PP}$
		89	96	—		$R_L = 500\text{ k}\Omega$ , $V_{OUT} = 4.8\text{ V}_{PP}$
Maximum Output Voltage Swing	$V_{OUT}$	$V_+ - 50\text{ mV}$	$V_+ - 37\text{ mV}$	—	V	$R_L = 5\text{ k}\Omega$
		$V_+ - 3\text{ mV}$	$V_+ - 1.3\text{ mV}$	—		$R_L = 500\text{ k}\Omega$
—		$V_- + 24\text{ mV}$	$V_- + 40\text{ mV}$	$R_L = 5\text{ k}\Omega$		
—		$V_- + 0.7\text{ mV}$	$V_- + 3\text{ mV}$	$R_L = 500\text{ k}\Omega$		
Minimum Output Voltage Swing						
Gain-Bandwidth Product	GBW	—	3	—	MHz	$R_L = 20\text{ k}\Omega$ , $C_L = 2\text{ pF}$ , $A_V = 11$
Phase Margin	PM	—	45	—	°	—
-3 dB Bandwidth	BW	—	5	—	MHz	$R_L = 1\text{ M}\Omega$ , $C_L = 2\text{ pF}$ , $A_V = 1$
Slew Rate	SR	—	4	—	V/ $\mu\text{s}$	$R_L = 1\text{ M}\Omega$ , $C_L = 2\text{ pF}$ , $A_V = 1$ , Positive Slew Rate = 1.5 V/ $\mu\text{s}$
Short-Circuit Output Current	$I_{SC}$	17	23	—	mA	Source
		18	27	—		Sink
Supply Current (per Op Amp)	$I_S$	—	31	47	$\mu\text{A}$	No Load
Channel-to-Channel Crosstalk	—	—	-120	—	dB	Note 1

**Note 1:** DC signal referenced to input. Refer to the [Typical Performance Curves](#) section's AC performance graphs.

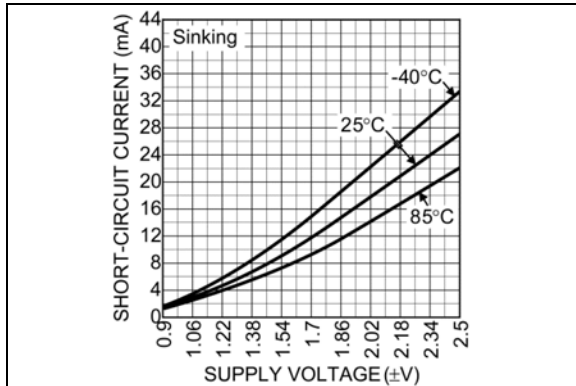
**TEMPERATURE SPECIFICATIONS (Note 1)**

Parameters	Sym.	Min.	Typ.	Max.	Units	Conditions
<b>Temperature Ranges</b>						
Operating Temperature Range	—	-40	—	+125	°C	—
Storage Temperature Range	T <sub>S</sub>	—	—	+150	°C	—
Ambient Temperature Range	T <sub>A</sub>	-40	—	+85	°C	—
<b>Package Thermal Resistance</b>						
Thermal Resistance SOT-23-8	$\theta_{JA}$	—	100	—	°C/W	Using 4-Layer PCB
	$\theta_{JC}$	—	70	—	°C/W	Using 4-Layer PCB

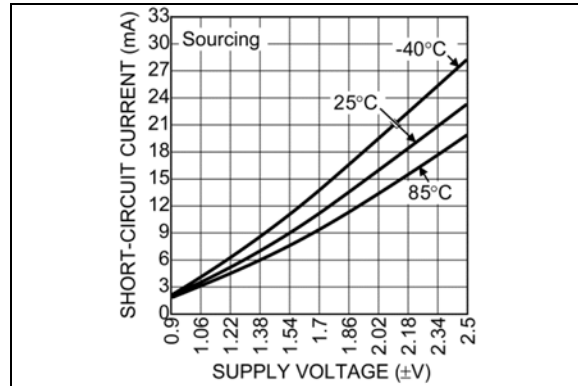
**Note 1:** The maximum allowable power dissipation is a function of ambient temperature, the maximum allowable junction temperature and the thermal resistance from junction to air (i.e., T<sub>A</sub>, T<sub>J</sub>,  $\theta_{JA}$ ). Exceeding the maximum allowable power dissipation will cause the device operating junction temperature to exceed the maximum +125°C rating. Sustained junction temperatures above +125°C can impact the device reliability.

## 2.0 TYPICAL PERFORMANCE CURVES

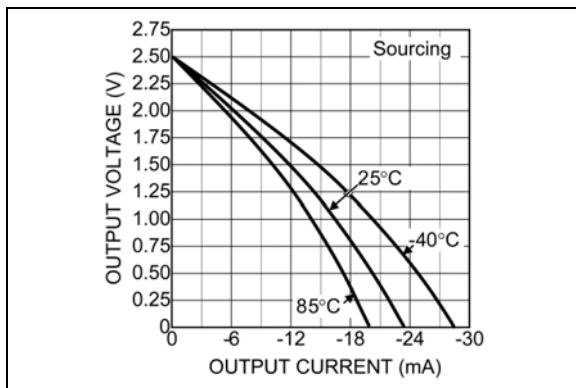
**Note:** The graphs and tables provided following this note are a statistical summary based on a limited number of samples and are provided for informational purposes only. The performance characteristics listed herein are not tested or guaranteed. In some graphs or tables, the data presented may be outside the specified operating range (e.g., outside specified power supply range) and therefore outside the warranted range.



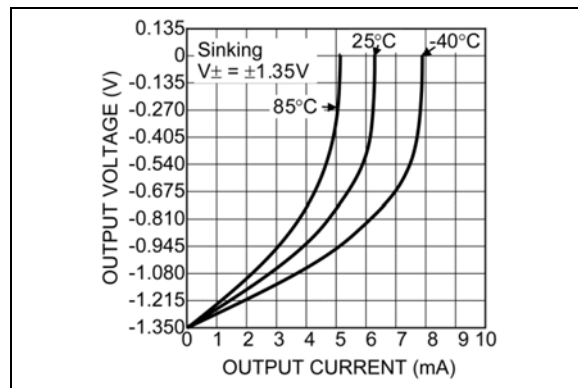
**FIGURE 2-1:** Short-Circuit Current vs. Supply Voltage.



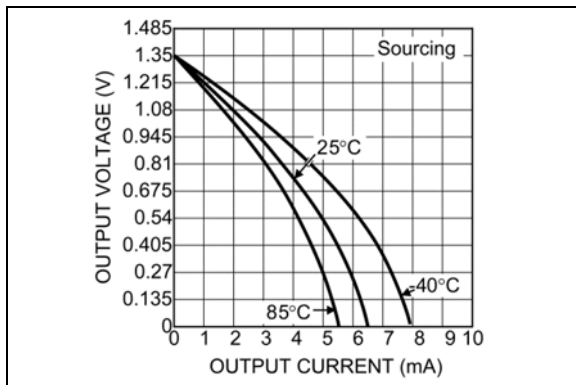
**FIGURE 2-4:** Short-Circuit Current vs. Supply Voltage.



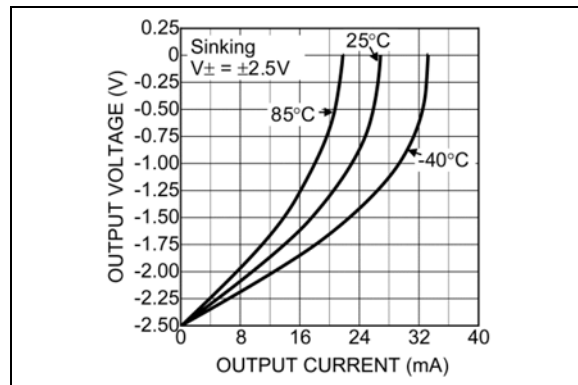
**FIGURE 2-2:** Output Voltage vs. Output Current.



**FIGURE 2-5:** Output Voltage vs. Output Current.

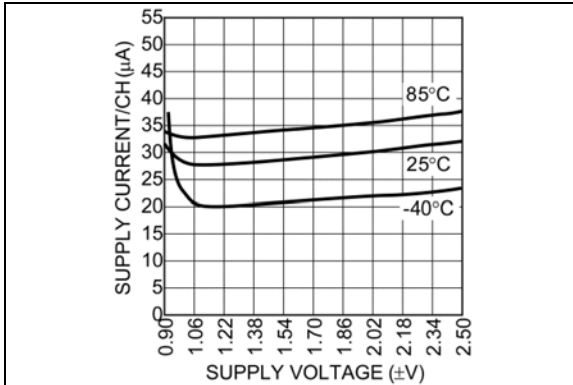


**FIGURE 2-3:** Output Voltage vs. Output Current.

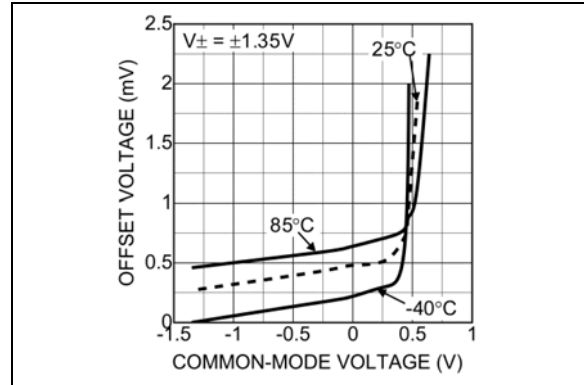


**FIGURE 2-6:** Output Voltage vs. Output Current.

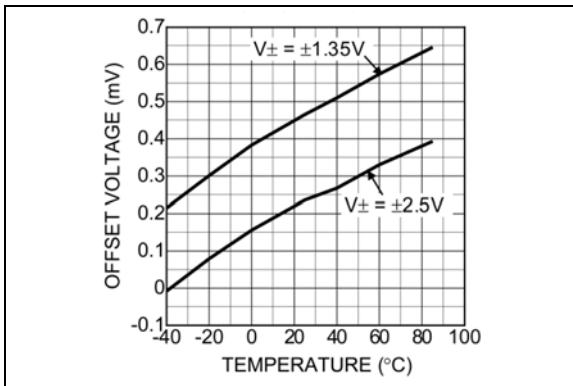




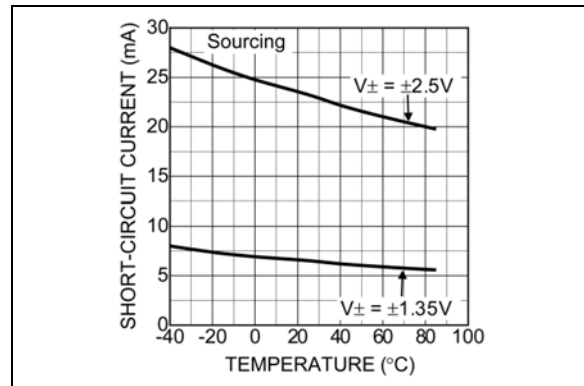
**FIGURE 2-7:** Supply Current vs. Supply Voltage.



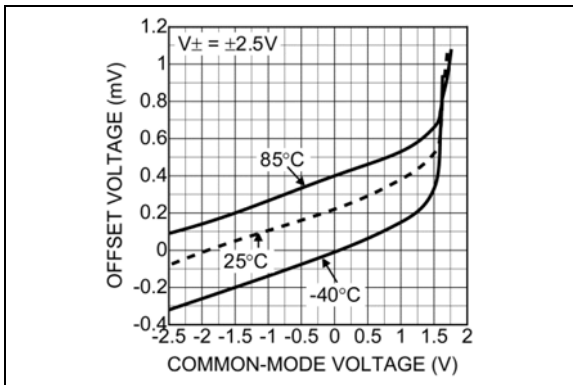
**FIGURE 2-10:** Offset Voltage vs. Common-Mode Voltage.



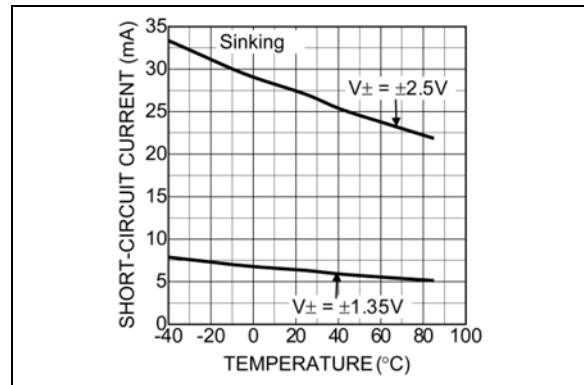
**FIGURE 2-8:** Offset Voltage vs. Temperature.



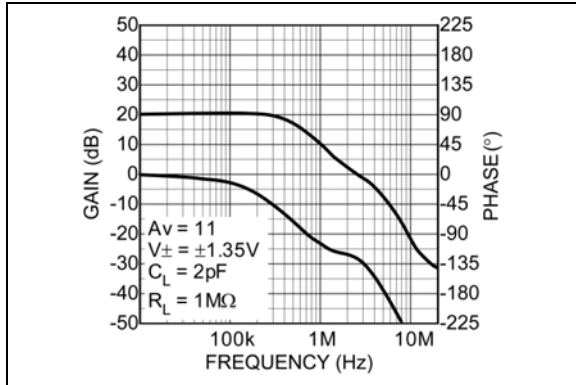
**FIGURE 2-11:** Short-Circuit Current vs. Temperature.



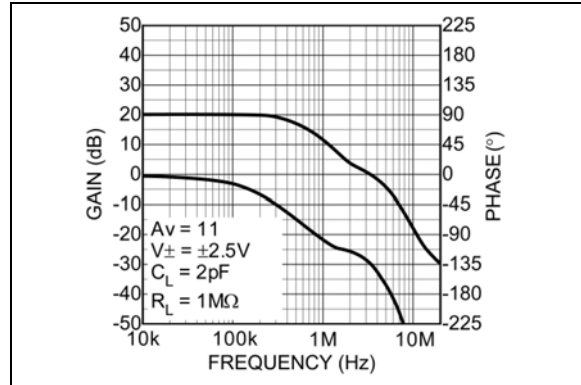
**FIGURE 2-9:** Offset Voltage vs. Common-Mode Voltage.



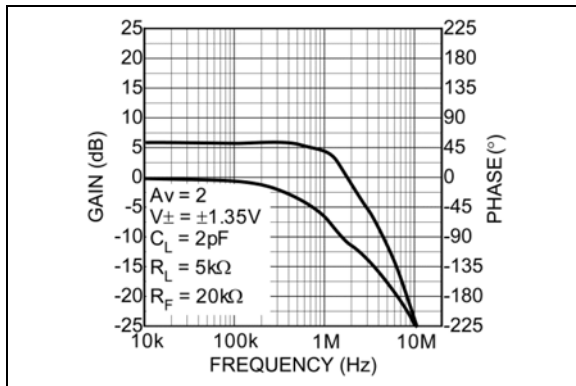
**FIGURE 2-12:** Short-Circuit Current vs. Temperature.



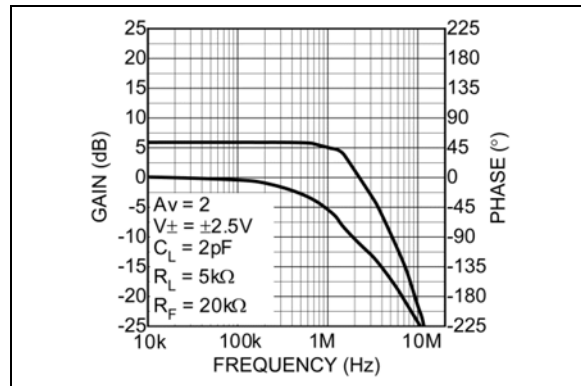
**FIGURE 2-13:** Gain Bandwidth and Phase Margin.



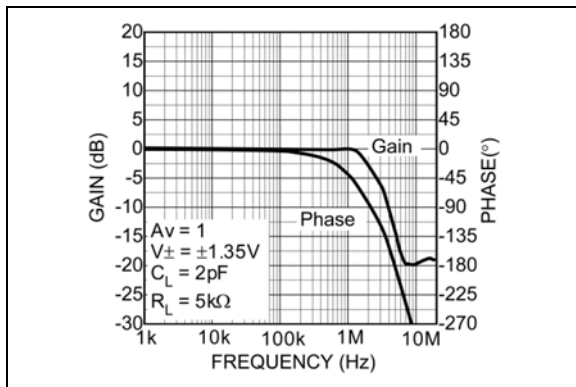
**FIGURE 2-16:** Gain Bandwidth and Phase Margin.



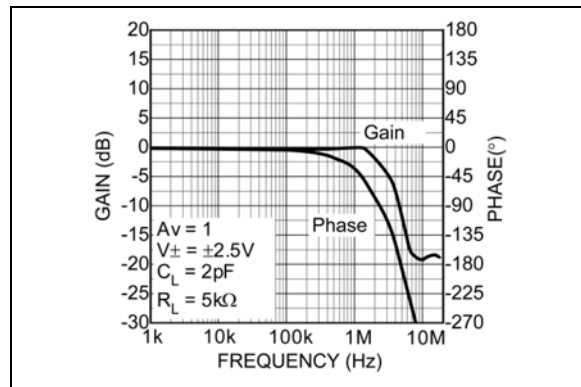
**FIGURE 2-14:** Gain Frequency Response.



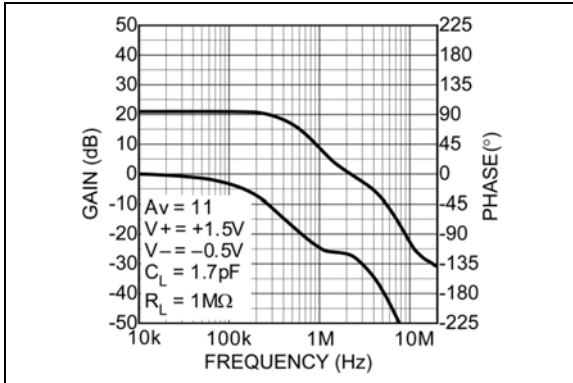
**FIGURE 2-17:** Gain Frequency Response.



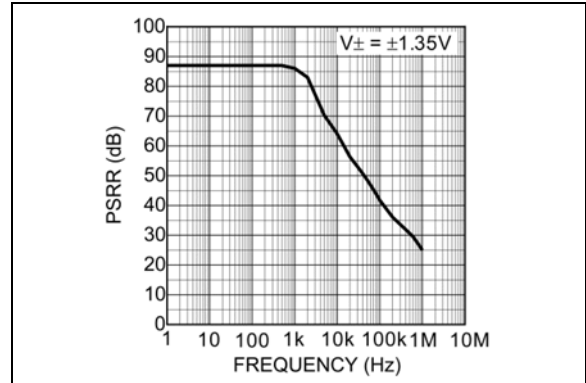
**FIGURE 2-15:** Unity Gain Frequency Response.



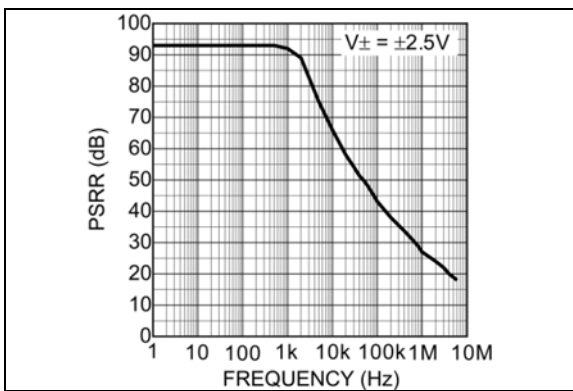
**FIGURE 2-18:** Unity Gain Frequency Response.



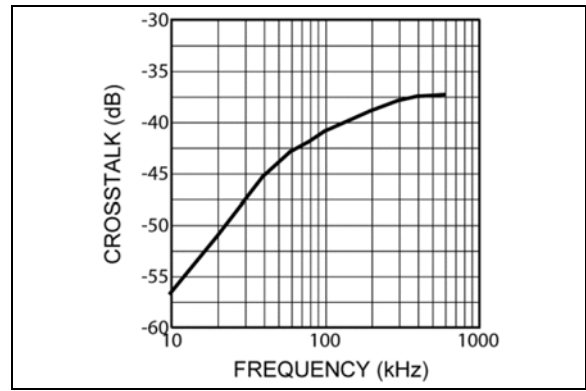
**FIGURE 2-19:** Gain Bandwidth and Phase Margin.



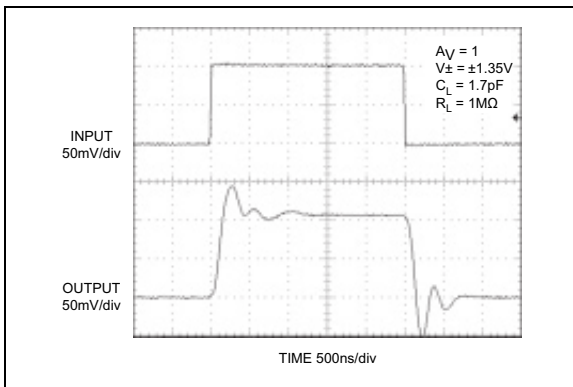
**FIGURE 2-22:** PSRR vs. Frequency.



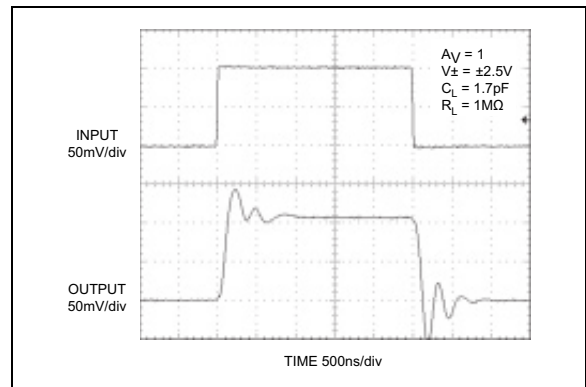
**FIGURE 2-20:** PSRR vs. Frequency.



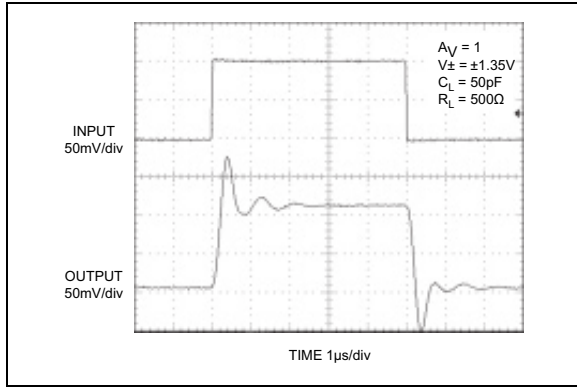
**FIGURE 2-23:** Channel-to-Channel Crosstalk.



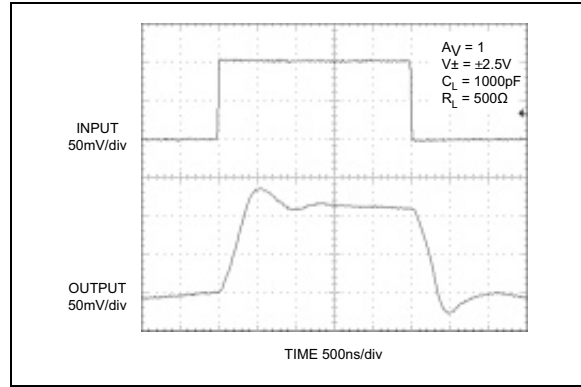
**FIGURE 2-21:** Small Signal Response.



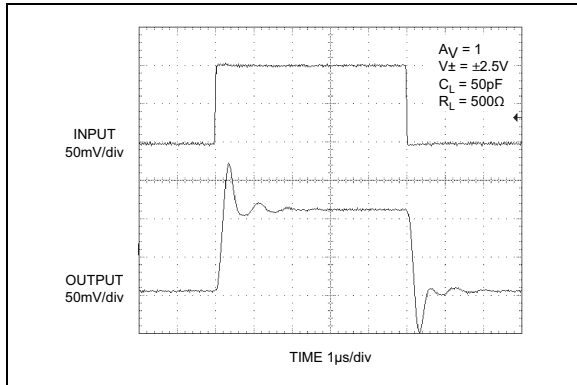
**FIGURE 2-24:** Small Signal Response.



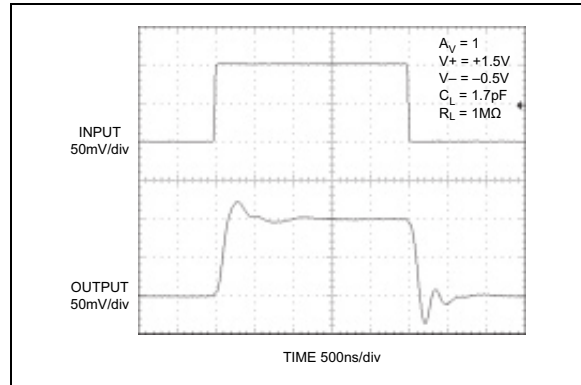
**FIGURE 2-25:** Small Signal Response.



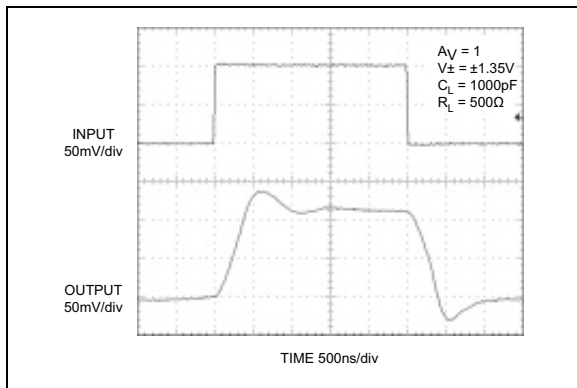
**FIGURE 2-28:** Small Signal Response.



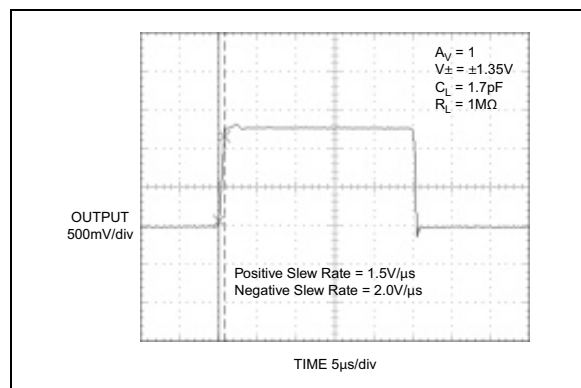
**FIGURE 2-26:** Small Signal Response.



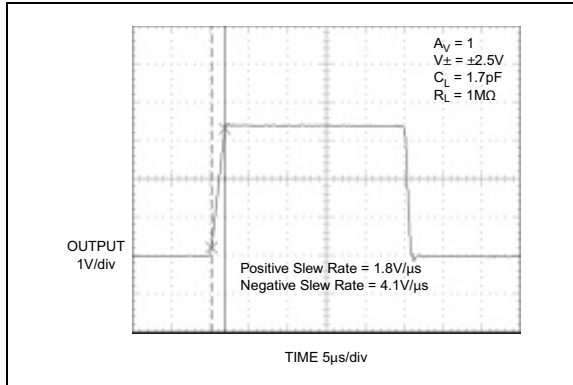
**FIGURE 2-29:** Small Signal Pulse Response.



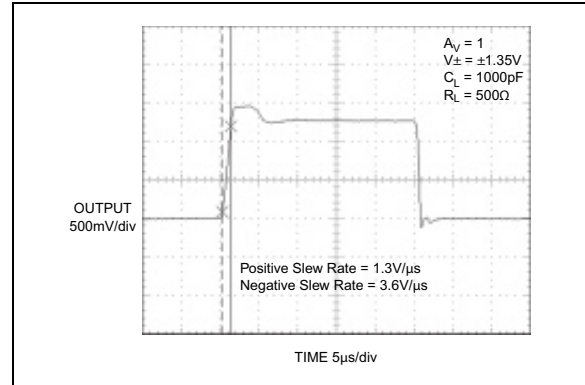
**FIGURE 2-27:** Small Signal Response.



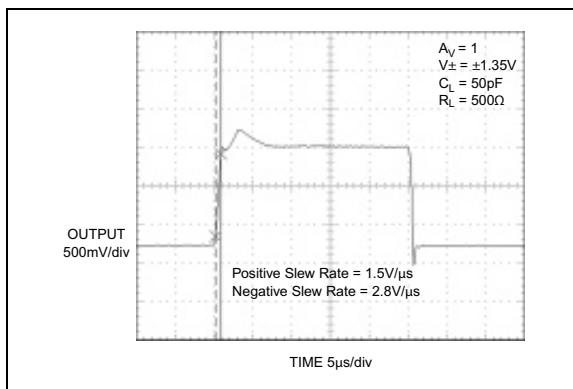
**FIGURE 2-30:** Large Signal Response.



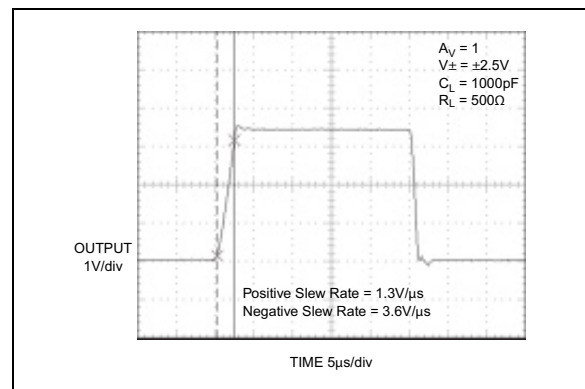
**FIGURE 2-31:** Large Signal Response.



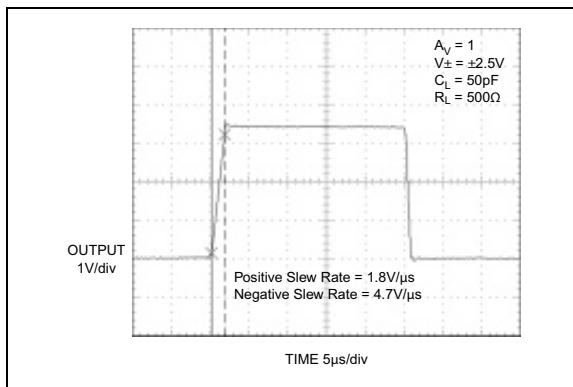
**FIGURE 2-34:** Large Signal Pulse Response.



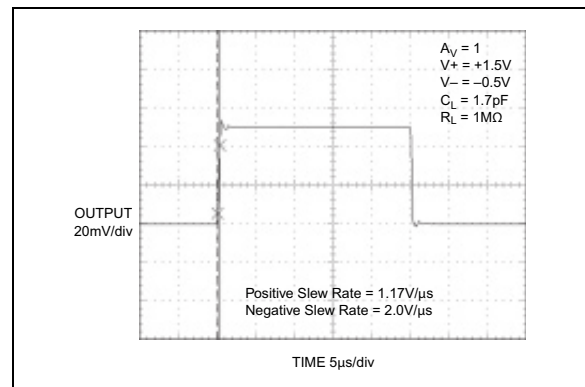
**FIGURE 2-32:** Large Signal Response.



**FIGURE 2-35:** Large Signal Pulse Response.

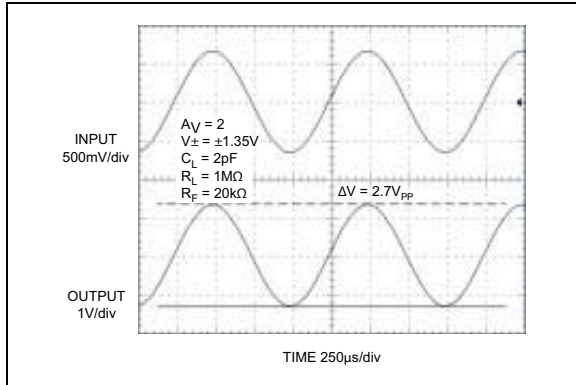


**FIGURE 2-33:** Large Signal Response.

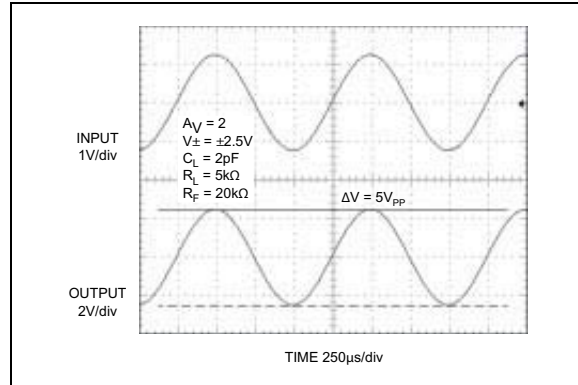


**FIGURE 2-36:** Large Signal Pulse Response.

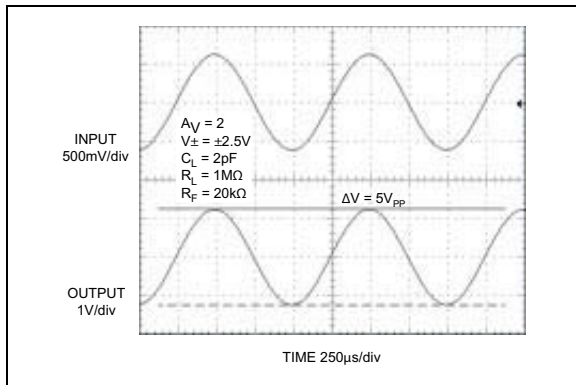
# MIC862



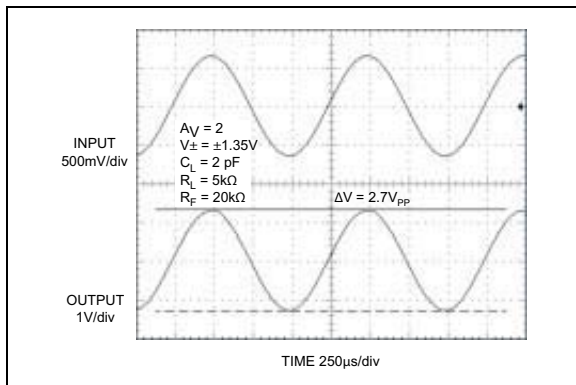
**FIGURE 2-37:** Rail-to-Rail Operation.



**FIGURE 2-40:** Rail-to-Rail Operation.



**FIGURE 2-38:** Rail-to-Rail Operation.



**FIGURE 2-39:** Rail-to-Rail Operation.

## 3.0 PIN DESCRIPTIONS

The descriptions of the pins are listed in [Table 3-1](#).

**TABLE 3-1: PIN FUNCTION TABLE**

Pin Number	Symbol	Description
1	OUTA	Amplifier A Output.
2	INA-	Amplifier A Inverting Input.
3	INA+	Amplifier A Non-Inverting Input
4	V-	Negative Supply.
5	INB+	Amplifier B Non-Inverting Input.
6	INB-	Amplifier B Inverting Input.
7	OUTB	Amplifier B Output.
8	V+	Positive Supply.

## 4.0 APPLICATION INFORMATION

### 4.1 Power Supply Bypassing

Regular supply bypassing techniques are recommended. A 10  $\mu\text{F}$  capacitor in parallel with a 0.1  $\mu\text{F}$  capacitor on both the positive and negative supplies are ideal. For best performance all bypassing capacitors should be located as close to the op amp as possible and all capacitors should be low ESL (equivalent series inductance), ESR (equivalent series resistance). Surface-mount ceramic capacitors are ideal.

### 4.2 Supply and Loading Resistive Considerations

The MIC862 is intended for single-supply applications configured with a grounded load. It is not advisable to operate the MIC862 under either of the following conditions:

- A grounded load and split supplies ( $\pm\text{V}$ )
- A single supply where the load is terminated above ground.

Under the above conditions, if the load is less than 20  $\text{k}\Omega$  and the output swing is greater than 1V (peak), there may be some instability when the output is sinking current.

### 4.3 Capacitive Load

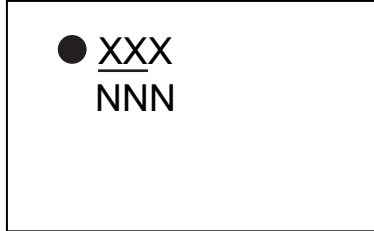
When driving a large capacitive load, a resistor of 500 $\Omega$  is recommended to be connected between the op amp output and the capacitive load to avoid oscillation.



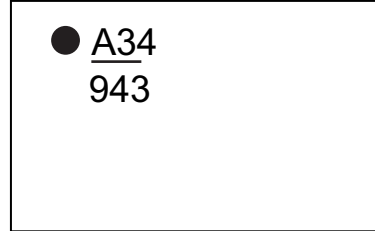
## 5.0 PACKAGING INFORMATION

### 5.1 Package Marking Information

8-Pin SOT-23\*



Example



<b>Legend:</b>	XX...X	Product code or customer-specific information
	Y	Year code (last digit of calendar year)
	YY	Year code (last 2 digits of calendar year)
	WW	Week code (week of January 1 is week '01')
	NNN	Alphanumeric traceability code
	(e3)	Pb-free JEDEC® designator for Matte Tin (Sn)
	*	This package is Pb-free. The Pb-free JEDEC designator (e3) can be found on the outer packaging for this package.
	•, ▲, ▼	Pin one index is identified by a dot, delta up, or delta down (triangle mark).
<b>Note:</b>	In the event the full Microchip part number cannot be marked on one line, it will be carried over to the next line, thus limiting the number of available characters for customer-specific information. Package may or may not include the corporate logo.	
	Underbar (̒) and/or Overbar (̑) symbol may not be to scale.	

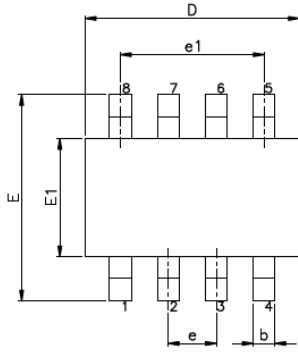
# MIC862

## 8-Lead SOT-23 Package Outline and Recommended Land Pattern

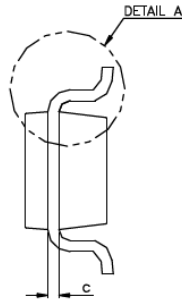
**TITLE**

8 LEAD SOT23 PACKAGE OUTLINE & RECOMMENDED LAND PATTERN

<b>DRAWING #</b>	SOT23-8LD-PL-1	<b>UNIT</b>	MM
<b>Lead Frame</b>	Copper Alloy	<b>Lead Finish</b>	Matte Tin



TOP VIEW

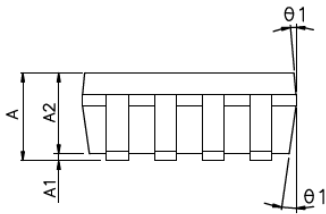


SIDE VIEW

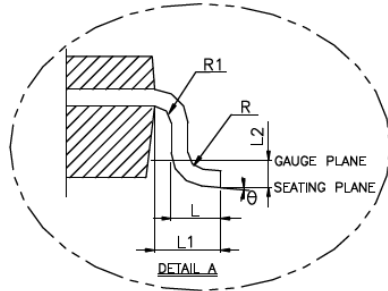
VARIATION(ALL DIMENSIONS SHOWN IN MM)

SYMBOL	MIN.	NOM.	MAX.
A	-	-	1.45
A1	0.00	-	0.15
A2	0.90	1.15	1.30
b	0.22	-	0.38
c	0.08	-	0.22
D	2.90 BSC.		
E	2.80 BSC.		
E1	1.60 BSC.		
e	0.65 BSC.		
e1	1.95 BSC.		
L	0.30	0.45	0.60
L1	0.60 REF.		
L2	0.25 BSC.		
R	0.10	-	-
R1	0.10	-	0.25
θ	0°	4°	8°
θ1	5°	10°	15°

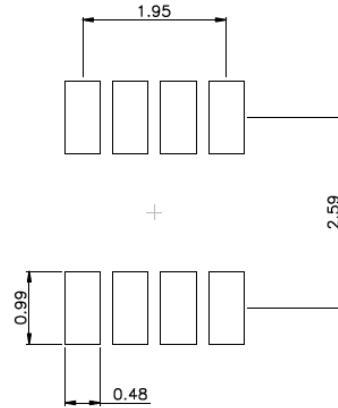
NOTE :  
1. JEDEC OUTLINE : MO-178 BA.



END VIEW



DETAIL A



RECOMMENDED LAND PATTERN

Note: For the most current package drawings, please see the Microchip Packaging Specification located at <http://www.microchip.com/packaging>.

## APPENDIX A: REVISION HISTORY

### Revision A (August 2017)

- Converted Micrel document MIC862 to Microchip data sheet template DS20005836A.
- Minor text changes throughout.
- Corrected the [Product Identification System](#) section by removing an erroneous letter T from the part number.

# MIC862

---

NOTES:

## PRODUCT IDENTIFICATION SYSTEM

To order or obtain information, e.g., on pricing or delivery, contact your local Microchip representative or sales office.

<u>PART NO.</u>	X	XX	-XX
Device	Temperature	Package	Media Type
<b>Device:</b> MIC862:		Dual Ultra-Low Power Op Amp	
<b>Temperature:</b> Y =	-40°C to +85°C		
<b>Package:</b> M8 =	8-Lead SOT-23		
<b>Media Type:</b> TR =	3,000/Reel		

**Examples:**

a) MIC862YM8-TR: Dual Ultra-Low Power Op Amp, -40°C to +85°C Junction Temperature Range, 8-Lead SOT-23 Package, 3,000/Reel

**Note 1:** Tape and Reel identifier only appears in the catalog part number description. This identifier is used for ordering purposes and is not printed on the device package. Check with your Microchip Sales Office for package availability with the Tape and Reel option.

# MIC862

---

NOTES:

---

**Note the following details of the code protection feature on Microchip devices:**

- Microchip products meet the specification contained in their particular Microchip Data Sheet.
- Microchip believes that its family of products is one of the most secure families of its kind on the market today, when used in the intended manner and under normal conditions.
- There are dishonest and possibly illegal methods used to breach the code protection feature. All of these methods, to our knowledge, require using the Microchip products in a manner outside the operating specifications contained in Microchip's Data Sheets. Most likely, the person doing so is engaged in theft of intellectual property.
- Microchip is willing to work with the customer who is concerned about the integrity of their code.
- Neither Microchip nor any other semiconductor manufacturer can guarantee the security of their code. Code protection does not mean that we are guaranteeing the product as “unbreakable.”

Code protection is constantly evolving. We at Microchip are committed to continuously improving the code protection features of our products. Attempts to break Microchip's code protection feature may be a violation of the Digital Millennium Copyright Act. If such acts allow unauthorized access to your software or other copyrighted work, you may have a right to sue for relief under that Act.

---

Information contained in this publication regarding device applications and the like is provided only for your convenience and may be superseded by updates. It is your responsibility to ensure that your application meets with your specifications. MICROCHIP MAKES NO REPRESENTATIONS OR WARRANTIES OF ANY KIND WHETHER EXPRESS OR IMPLIED, WRITTEN OR ORAL, STATUTORY OR OTHERWISE, RELATED TO THE INFORMATION, INCLUDING BUT NOT LIMITED TO ITS CONDITION, QUALITY, PERFORMANCE, MERCHANTABILITY OR FITNESS FOR PURPOSE. Microchip disclaims all liability arising from this information and its use. Use of Microchip devices in life support and/or safety applications is entirely at the buyer's risk, and the buyer agrees to defend, indemnify and hold harmless Microchip from any and all damages, claims, suits, or expenses resulting from such use. No licenses are conveyed, implicitly or otherwise, under any Microchip intellectual property rights unless otherwise stated.

*Microchip received ISO/TS-16949:2009 certification for its worldwide headquarters, design and wafer fabrication facilities in Chandler and Tempe, Arizona; Gresham, Oregon and design centers in California and India. The Company's quality system processes and procedures are for its PIC® MCUs and dsPIC® DSCs, KEELoC® code hopping devices, Serial EEPROMs, microperipherals, nonvolatile memory and analog products. In addition, Microchip's quality system for the design and manufacture of development systems is ISO 9001:2000 certified.*

**QUALITY MANAGEMENT SYSTEM  
CERTIFIED BY DNV  
= ISO/TS 16949 =**

**Trademarks**

The Microchip name and logo, the Microchip logo, AnyRate, AVR, AVR logo, AVR Freaks, BeaconThings, BitCloud, CryptoMemory, CryptoRF, dsPIC, FlashFlex, flexPWR, Heldo, JukeBlox, KEELoC, KEELoC logo, Klear, LANCheck, LINK MD, maXStylus, maXTouch, MediaLB, megaAVR, MOST, MOST logo, MPLAB, OptoLyzer, PIC, picoPower, PICSTART, PIC32 logo, Prochip Designer, QTouch, RightTouch, SAM-BA, SpyNIC, SST, SST Logo, SuperFlash, tinyAVR, UNI/O, and XMEGA are registered trademarks of Microchip Technology Incorporated in the U.S.A. and other countries.

ClockWorks, The Embedded Control Solutions Company, EtherSynch, Hyper Speed Control, HyperLight Load, IntelliMOS, mTouch, Precision Edge, and Quiet-Wire are registered trademarks of Microchip Technology Incorporated in the U.S.A.

Adjacent Key Suppression, AKS, Analog-for-the-Digital Age, Any Capacitor, AnyIn, AnyOut, BodyCom, chipKIT, chipKIT logo, CodeGuard, CryptoAuthentication, CryptoCompanion, CryptoController, dsPICDEM, dsPICDEM.net, Dynamic Average Matching, DAM, ECAN, EtherGREEN, In-Circuit Serial Programming, ICSP, Inter-Chip Connectivity, JitterBlocker, KlearNet, KlearNet logo, Mindi, MiWi, motorBench, MPASM, MPF, MPLAB Certified logo, MPLIB, MPLINK, MultiTRAK, NetDetach, Omniscient Code Generation, PICDEM, PICDEM.net, PICKit, PICTail, PureSilicon, QMatrix, RightTouch logo, REAL ICE, Ripple Blocker, SAM-ICE, Serial Quad I/O, SMART-I.S., SQI, SuperSwitcher, SuperSwitcher II, Total Endurance, TSHARC, USBCheck, VariSense, ViewSpan, WiperLock, Wireless DNA, and ZENA are trademarks of Microchip Technology Incorporated in the U.S.A. and other countries.

SQTP is a service mark of Microchip Technology Incorporated in the U.S.A.

Silicon Storage Technology is a registered trademark of Microchip Technology Inc. in other countries.

GestIC is a registered trademark of Microchip Technology Germany II GmbH & Co. KG, a subsidiary of Microchip Technology Inc., in other countries.

All other trademarks mentioned herein are property of their respective companies.

© 2017, Microchip Technology Incorporated, All Rights Reserved.  
ISBN: 978-1-5224-2084-2



# MICROCHIP

## Worldwide Sales and Service

### AMERICAS

**Corporate Office**  
2355 West Chandler Blvd.  
Chandler, AZ 85224-6199  
Tel: 480-792-7200  
Fax: 480-792-7277  
Technical Support:  
<http://www.microchip.com/support>  
Web Address:  
[www.microchip.com](http://www.microchip.com)

**Atlanta**  
Duluth, GA  
Tel: 678-957-9614  
Fax: 678-957-1455

**Austin, TX**  
Tel: 512-257-3370

**Boston**  
Westborough, MA  
Tel: 774-760-0087  
Fax: 774-760-0088

**Chicago**  
Itasca, IL  
Tel: 630-285-0071  
Fax: 630-285-0075

**Dallas**  
Addison, TX  
Tel: 972-818-7423  
Fax: 972-818-2924

**Detroit**  
Novi, MI  
Tel: 248-848-4000

**Houston, TX**  
Tel: 281-894-5983

**Indianapolis**  
Noblesville, IN  
Tel: 317-773-8323  
Fax: 317-773-5453  
Tel: 317-536-2380

**Los Angeles**  
Mission Viejo, CA  
Tel: 949-462-9523  
Fax: 949-462-9608  
Tel: 951-273-7800

**Raleigh, NC**  
Tel: 919-844-7510

**New York, NY**  
Tel: 631-435-6000

**San Jose, CA**  
Tel: 408-735-9110  
Tel: 408-436-4270

**Canada - Toronto**  
Tel: 905-695-1980  
Fax: 905-695-2078

### ASIA/PACIFIC

**Asia Pacific Office**  
Suites 3707-14, 37th Floor  
Tower 6, The Gateway  
Harbour City, Kowloon

**Hong Kong**  
Tel: 852-2943-5100  
Fax: 852-2401-3431

**Australia - Sydney**  
Tel: 61-2-9868-6733  
Fax: 61-2-9868-6755

**China - Beijing**  
Tel: 86-10-8569-7000  
Fax: 86-10-8528-2104

**China - Chengdu**  
Tel: 86-28-8665-5511  
Fax: 86-28-8665-7889

**China - Chongqing**  
Tel: 86-23-8980-9588  
Fax: 86-23-8980-9500

**China - Dongguan**  
Tel: 86-769-8702-9880

**China - Guangzhou**  
Tel: 86-20-8755-8029

**China - Hangzhou**  
Tel: 86-571-8792-8115  
Fax: 86-571-8792-8116

**China - Hong Kong SAR**  
Tel: 852-2943-5100  
Fax: 852-2401-3431

**China - Nanjing**  
Tel: 86-25-8473-2460  
Fax: 86-25-8473-2470

**China - Qingdao**  
Tel: 86-532-8502-7355  
Fax: 86-532-8502-7205

**China - Shanghai**  
Tel: 86-21-3326-8000  
Fax: 86-21-3326-8021

**China - Shenyang**  
Tel: 86-24-2334-2829  
Fax: 86-24-2334-2393

**China - Shenzhen**  
Tel: 86-755-8864-2200  
Fax: 86-755-8203-1760

**China - Wuhan**  
Tel: 86-27-5980-5300  
Fax: 86-27-5980-5118

**China - Xian**  
Tel: 86-29-8833-7252  
Fax: 86-29-8833-7256

### ASIA/PACIFIC

**China - Xiamen**  
Tel: 86-592-2388138  
Fax: 86-592-2388130

**China - Zhuhai**  
Tel: 86-756-3210040  
Fax: 86-756-3210049

**India - Bangalore**  
Tel: 91-80-3090-4444  
Fax: 91-80-3090-4123

**India - New Delhi**  
Tel: 91-11-4160-8631  
Fax: 91-11-4160-8632

**India - Pune**  
Tel: 91-20-3019-1500

**Japan - Osaka**  
Tel: 81-6-6152-7160  
Fax: 81-6-6152-9310

**Japan - Tokyo**  
Tel: 81-3-6880-3770  
Fax: 81-3-6880-3771

**Korea - Daegu**  
Tel: 82-53-744-4301  
Fax: 82-53-744-4302

**Korea - Seoul**  
Tel: 82-2-554-7200  
Fax: 82-2-558-5932 or  
82-2-558-5934

**Malaysia - Kuala Lumpur**  
Tel: 60-3-6201-9857  
Fax: 60-3-6201-9859

**Malaysia - Penang**  
Tel: 60-4-227-8870  
Fax: 60-4-227-4068

**Philippines - Manila**  
Tel: 63-2-634-9065  
Fax: 63-2-634-9069

**Singapore**  
Tel: 65-6334-8870  
Fax: 65-6334-8850

**Taiwan - Hsin Chu**  
Tel: 886-3-5778-366  
Fax: 886-3-5770-955

**Taiwan - Kaohsiung**  
Tel: 886-7-213-7830

**Taiwan - Taipei**  
Tel: 886-2-2508-8600  
Fax: 886-2-2508-0102

**Thailand - Bangkok**  
Tel: 66-2-694-1351  
Fax: 66-2-694-1350

### EUROPE

**Austria - Wels**  
Tel: 43-7242-2244-39  
Fax: 43-7242-2244-393

**Denmark - Copenhagen**  
Tel: 45-4450-2828  
Fax: 45-4485-2829

**Finland - Espoo**  
Tel: 358-9-4520-820

**France - Paris**  
Tel: 33-1-69-53-63-20  
Fax: 33-1-69-30-90-79

**France - Saint Cloud**  
Tel: 33-1-30-60-70-00

**Germany - Garching**  
Tel: 49-8931-9700

**Germany - Haan**  
Tel: 49-2129-3766400

**Germany - Heilbronn**  
Tel: 49-7131-67-3636

**Germany - Karlsruhe**  
Tel: 49-721-625370

**Germany - Munich**  
Tel: 49-89-627-144-0  
Fax: 49-89-627-144-44

**Germany - Rosenheim**  
Tel: 49-8031-354-560

**Israel - Ra'anana**  
Tel: 972-9-744-7705

**Italy - Milan**  
Tel: 39-0331-742611  
Fax: 39-0331-466781

**Italy - Padova**  
Tel: 39-049-7625286

**Netherlands - Drunen**  
Tel: 31-416-690399  
Fax: 31-416-690340

**Norway - Trondheim**  
Tel: 47-7289-7561

**Poland - Warsaw**  
Tel: 48-22-3325737

**Romania - Bucharest**  
Tel: 40-21-407-87-50

**Spain - Madrid**  
Tel: 34-91-708-08-90  
Fax: 34-91-708-08-91

**Sweden - Gothenberg**  
Tel: 46-31-704-60-40

**Sweden - Stockholm**  
Tel: 46-8-5090-4654

**UK - Wokingham**  
Tel: 44-118-921-5800  
Fax: 44-118-921-5820