

Keywords: IBA power supply, 50watts, MAX5003, synchronous rectification, single switch forward converter

APPLICATION NOTE 3539

A 50 Watt Internal Bus Architecture (IBA) Power Supply

By: Suresh Hariharan, Director and Product Definer
Jun 20, 2005

Abstract: This article discusses a 12V/50W bus-converter that provides a well-regulated, efficient, isolated 12 volts from a 48V bus. The topology used is a single-switch forward converter with synchronous rectification. The MAX5003 is the PWM controller used in this design, which is optimized for the narrow input-voltage range of 48V, $\pm 5\%$.

Introduction

An Internal Bus Architecture (IBA) includes two power-conversion stages. The first stage uses a bus converter to obtain an intermediate bus voltage. The second stage uses point-of-load (POL) converters to convert the intermediate bus voltage to one or several low, well-regulated voltages to power the nearby loads. In this article we describe a 12V/50W bus converter that provides a well-regulated, isolated 12V from a 48V bus.

Power Supply Specification

- Input voltage: 48VDC, $\pm 5\%$ regulation
- Output voltage: 12V at 4.2A
- Minimum load: zero amps
- Ripple: $\pm 1\%$ peak-to-peak
- Isolation: 1500VAC
- Low cost
- Efficiency: $> 90\%$
- Output should be short-circuit and overload protected

Power Conversion Topology

There are several power conversion topologies to choose among for this design. The chosen topology must be low cost and efficient. Due to the low cost requirement we have to choose a direct-driven, single-switch topology. The high-efficiency goal requires synchronous rectification in the secondary. The choices most suitable for this design are:

- Single-switch flyback with synchronous rectification on the secondary (**Figure 1**)

Single-switch forward with primary reset winding and synchronous rectification on the secondary (**Figure 2**).

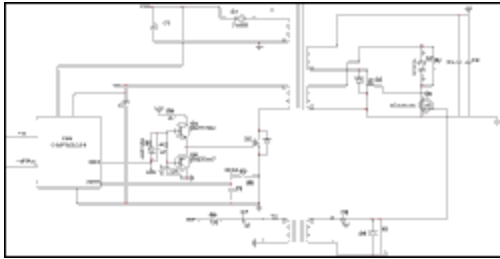

[For Larger Image](#)

Figure 1. A flyback converter with synchronous rectification.

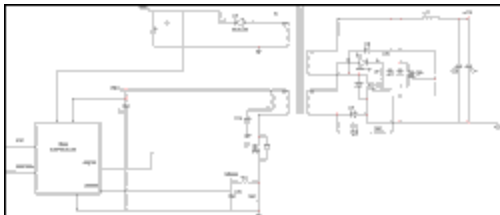

[For Larger Image](#)

Figure 2. Forward converter with reset winding and synchronous rectification.

The single-switch flyback topology has the advantage over the forward in the absence of an output inductor. We must add the extra drive transformer, T2, with the additional circuitry that transfers the primary drive signal from the PWM controller, U1, to the secondary stage. This signal is then used to turn off the synchronous MOSFET Q2 in the secondary stage just prior to turning off the primary MOSFET Q1. In addition, the Q3, Q5, C6, R3, D3, and R4 circuitry is added to delay the turn on of MOSFET Q1, thereby guaranteeing that secondary MOSFET Q2 turns off before Q1 turns on. Without this circuitry, there would be a short circuit across the transformer secondary until MOSFET Q2 turns off, causing, in turn, current spikes in MOSFET Q1 when it turns on.

In the single-switch forward-converter topology we need an extra inductor, but the output capacitance could be smaller than in the flyback design. We can also avoid the extra drive transformer (T2 above) by ensuring that the transformer T1 has been completely reset, and that the voltage across the transformer is at zero prior to the turn on of the primary switch.

Since the IBA power supply has a narrow input voltage range, we can maximize the operating duty cycle. The MAX5003 PWM controller will be used in the design described below. **Figure 3** is the schematic of the actual power supply.

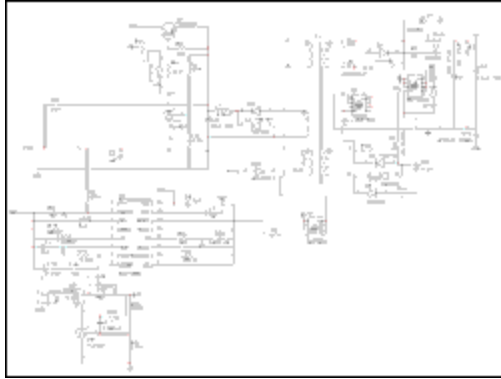

[For Larger Image](#)

Figure 3. Schematic of actual power supply.

Component list for the power supply

Designator	Qty	Description
C1	1	Ceramic capacitor 470pF, X7R, 50V, 10% (0402) TDK C1005X7R1H471K
C10	1	Ceramic capacitor 0.33 μ F, X5R, 6.3V, 10% (0402) TDK C1005X5R0J334K
C11	1	Ceramic capacitor 1 μ F, X5R, 6.3V, 20% (0402) TDK C1005X5R0J105M
C12	1	Ceramic capacitor 2200pF, X7R, 50V, 10% (0402) TDK C1005X7R1H222K
C13	1	Ceramic capacitor 0.1 μ F, X5R, 25V, 20% (0603) TDK C1608X7R1E104M
C14, C17	2	Ceramic capacitor 0.068 μ F, 16V, 10% (0402) TDKC1005X5R1C683Kex
C15	1	Ceramic capacitor 4700pF, 250VAC, X7R (2220) Murata GA355DR7GC472KY02
C2, C3, C4	3	Polymer tantalum chip capacitor 47 μ F, 16V, 20% Kemet T520D476M016ASE070
C5	1	Ceramic capacitor 1 μ F, 100V, X7R, 10% (1210) TDKC3225X7R2A105K
C6	2	Ceramic capacitor 1 μ F, 16V, X7R, 20%, (0805) TDKC2012X7R1C105M
C8	1	SMT Electrolytic capacitor 22 μ F, 50V, 20% Panasonic EEVFK1H220P
D1	1	Zener diode 6.2V, 200mW (SOD323)
D2-D5, D7-D10, D12	9	Switching diode 75V, 150ma (SOD323) Diodes Inc 1N4148W
D11	1	Silicon Epitaxial Planar Rectifier 200V, 200ma (SMINI2P) Panasonic MA115

D5	1	Schottky diode 3A, 40A (SMA) Diodes Inc B340A
L1	1	Inductor 3.3mh Coilcraft DO1608C-335
L2	1	Inductor 12 μ H Coilcraft DO5022P-103ML
Q3	1	Transistor PNP 60V SOT23 MMBT2907 Diodes Inc MMBT2907
Q4	1	N channel MOSFET, 80V, 15m Ω , SO8 International Rectifier IRF7493
Q5	1	N channel MOSFET 30V, 13.8m Ω , SO8 International Rectifier IRF7807Z
Q7	1	Nchannel MOSFET 200V, 79m Ω , SO8 International Rectifier IRF7892
Q6	1	N channel MOSFET, 30V, 1.2A, SOT23 Fairchild Semiconductor NDS351AN
R1	1	Resistor 27k, 5% (1206)
R10, R20	2	Resistor 20.0k, 1% (0402)
R11-R14	4	Resistor 1 Ω 5% (0603)
R15	1	Resistor 66.5k, 1% (0402)
R16	1	Resistor 1.24k, 1% (0402)
R17	1	1.24k, 1%
R18	1	Resistor 562 Ω , 1% (1206)
R19	1	Resistor 1k, 1% (1206)
R21	1	Resistor 100 Ω , 1% (0402)
R22	1	Resistor 60.4k, 1% (0402)
R23	1	Resistor 0.025 Ω , 1% (0805)
R27	1	Resistor 2.32k, 1% (0402)
R3	1	Resistor 261k, 1% (0402)
R4	1	Resistor 5.1k, 1% (0402)
R5	1	Resistor 490 Ω , 1% (0402)
R6	1	Resistor 221k, 1% (0402)
R7	1	Resistor 22 Ω , 1% (1206)
R8	1	Resistor 15k, 1% (0402)
R9	1	Resistor 453k, 1% (0805)
T1	1	Custom transformer (EFD20-12) Delta 2004D-535A
U1	1	High Voltage PWM Power Supply Controller MAXIM MAX5003ESE
U2, U4	2	Adjustable shunt regulator SOT23-5

		Texas instruments TLV431IDB
U3	1	SMD Optoisolator 1channel HiCTR
		NEC PS2911-1

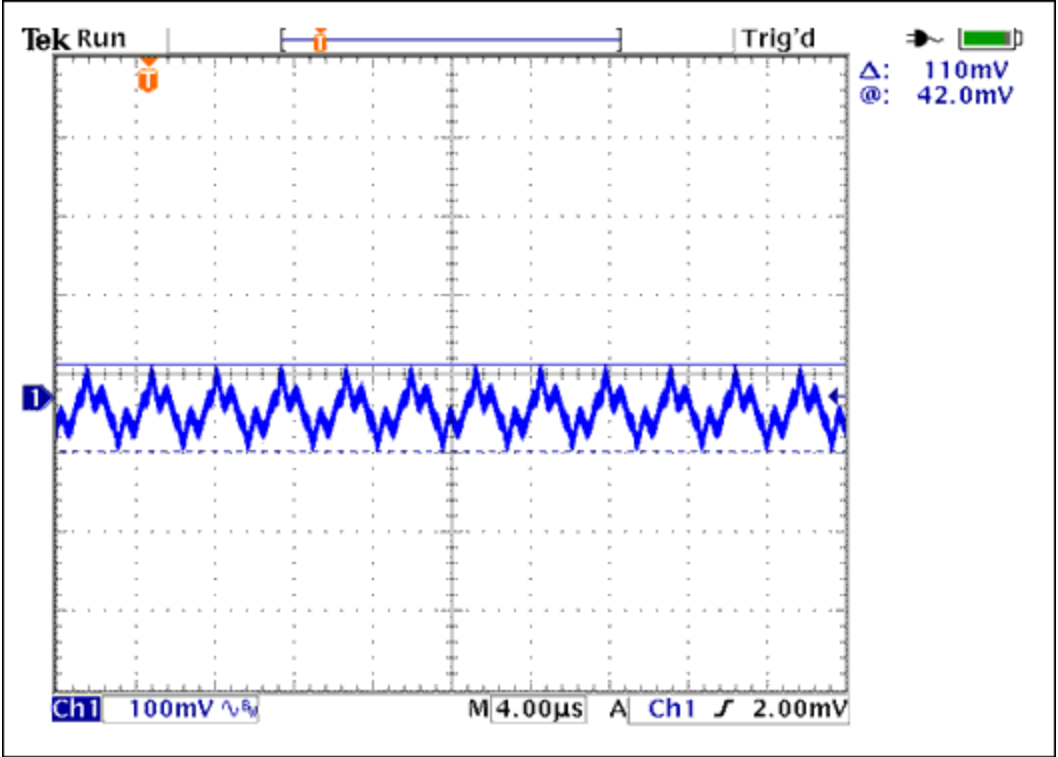

Figure 4. Ripple and noise at 12V/4.2A (input is 48VDC).

Note: The Bandwidth used in the ripple and noise measurement is 20MHz. The peak-to-peak ripple at full load and 48V input is 110mV.

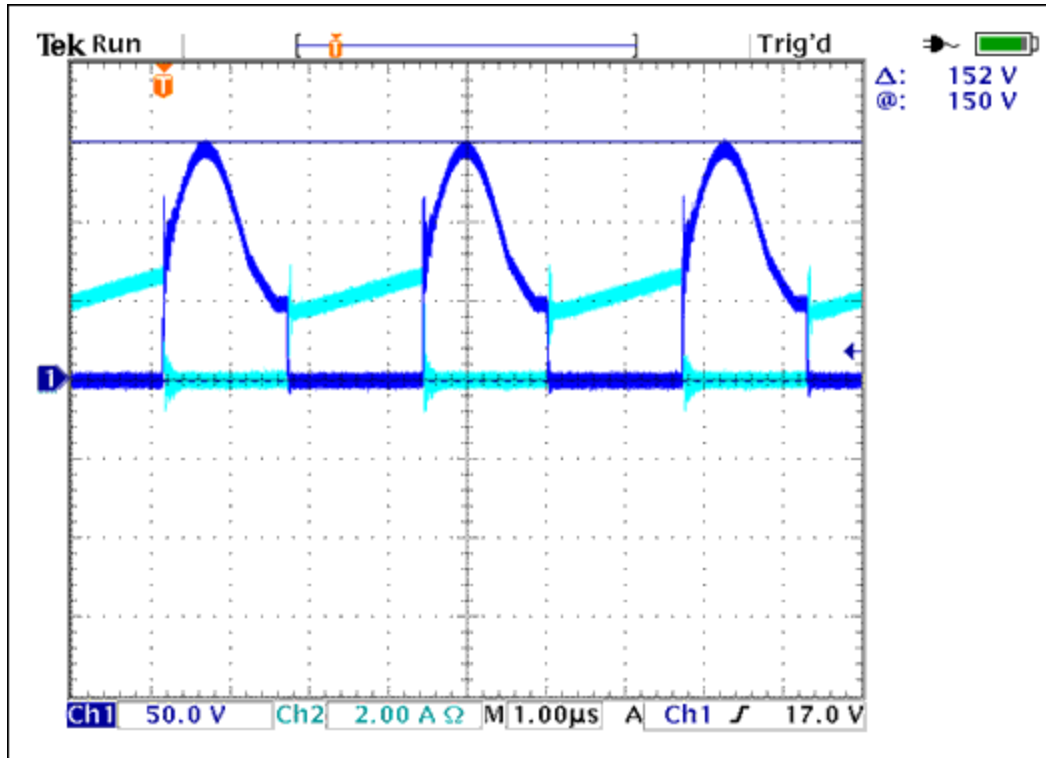

Figure 5. VDS and ID in Q7 at 50W output and 48VDC input.

Note: The peak voltage on Q7 is 152V at an input of 48V input. This is because the reset winding does not clamp and the transformer gets reset by the LC resonance formed by the transformer magnetizing inductance and the total reflected capacitance across the Q7 (D-S). This includes the transformer primary capacitance, the MOSFET Q7 capacitance, and the reflected capacitance from Q5 (D-S). Also note that the transformer voltage has reached zero just prior to the turn on of Q7. Reducing the conduction time interval for diode D5 thus optimizes the efficiency.

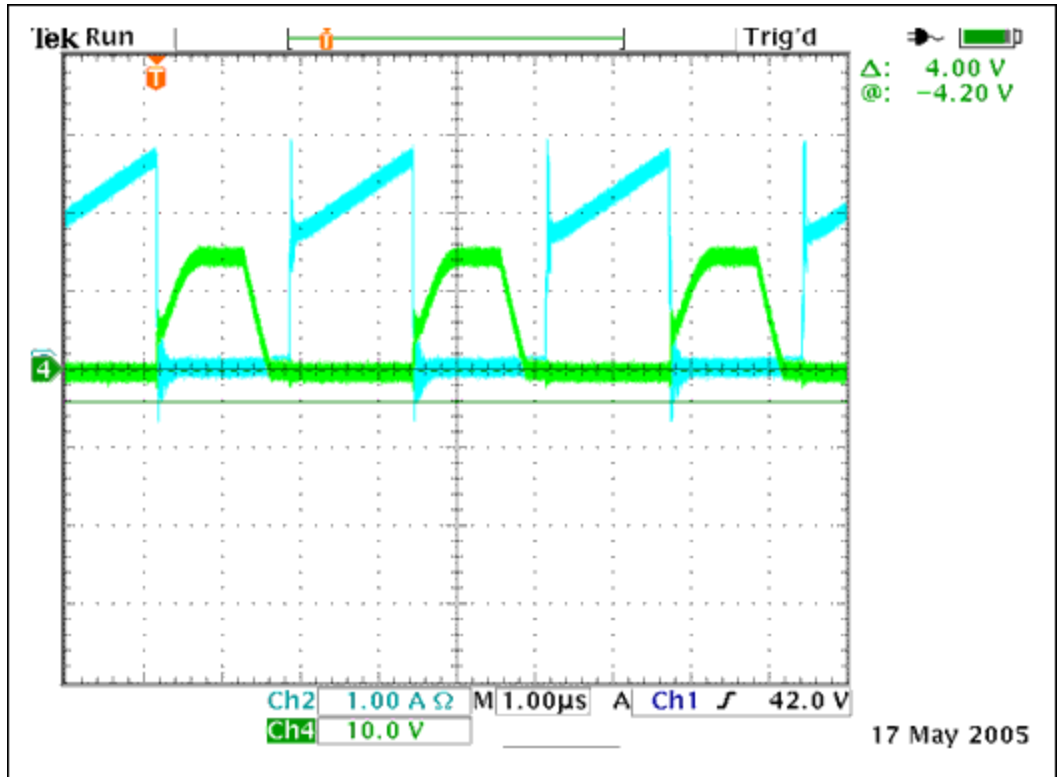

Figure 6. Current in Q7 and VGS on Q5 at full load and 48VDC input.

Note: The synchronous freewheeling MOSFET Q5 has been turned off before Q7 turns on, thus preventing current spikes in Q7. These current spikes would reduce the efficiency.

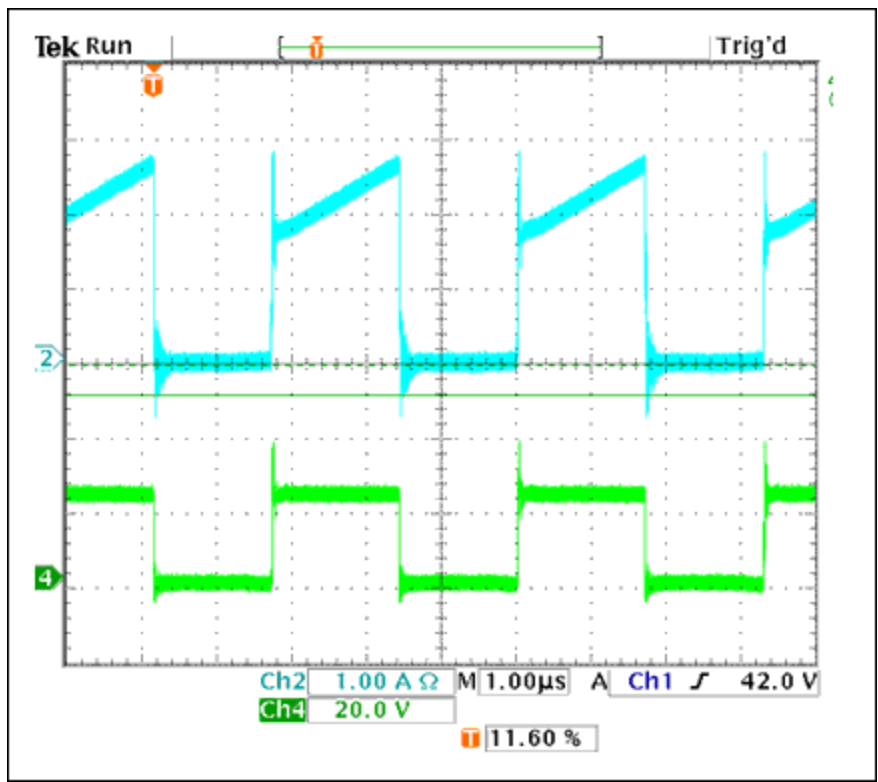

Figure 7. Current in Q7 and VDS on Q5 at full load and 48VDC input.

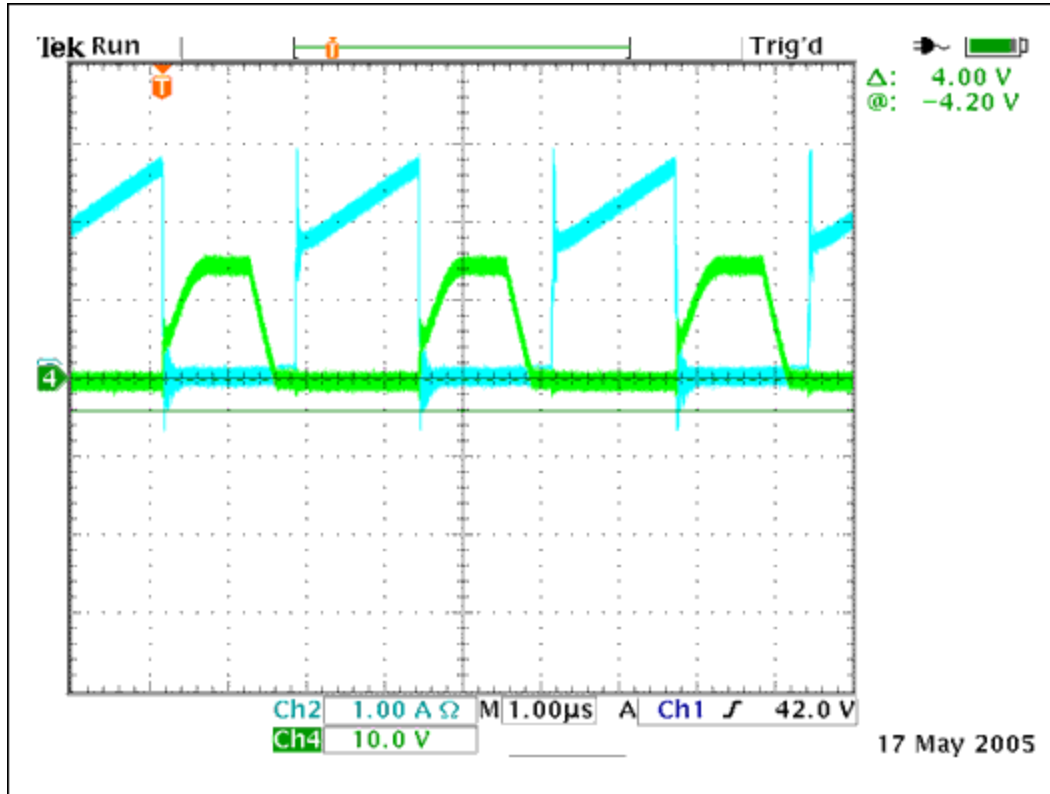

Figure 8. Current in Q7 and VGS on Q5 at full load and 48VDC input.

Note: The measured efficiency of this power supply at 50W at an input of 48V was 93%. The power supply met all the requirements specified for the design. Under short circuit, the supply would go into hiccup current limit, which would recover into full load when the short was removed.

Related Parts

MAX5003	High-Voltage PWM Power-Supply Controller	Free Samples
MAX5003	High-Voltage PWM Power-Supply Controller	Free Samples

More Information

For Technical Support: <http://www.maximintegrated.com/support>

For Samples: <http://www.maximintegrated.com/samples>

Other Questions and Comments: <http://www.maximintegrated.com/contact>

Application Note 3539: <http://www.maximintegrated.com/an3539>

APPLICATION NOTE 3539, AN3539, AN 3539, APP3539, Appnote3539, Appnote 3539

Copyright © by Maxim Integrated Products

Additional Legal Notices: <http://www.maximintegrated.com/legal>