

Austin MicroLynx™ 5A: Non-Isolated DC-DC Power Module

3.0Vdc –5.8Vdc input; 0.75Vdc to 4.0Vdc output; 5A Output Current

RoHS Compliant



Applications

- Distributed power architectures
- Intermediate bus voltage applications
- Telecommunications equipment
- Servers and storage applications
- Networking equipment

Features

- Compliant to RoHS Directive 2011/65/EU and amended Directive (EU) 2015/863
- Compliant to REACH Directive (EC) No 1907/2006
- Delivers up to 5A output current
- High efficiency – 94% at 3.3V full load ($V_{IN} = 5.0V$)
- Small size and low profile:
- 20.3 mm x 11.4 mm x 5.97 mm
- (0.80 in x 0.45 in x 0.235 in)
- Low output ripple and noise
- High Reliability:
- Calculated MTBF = 19M hours at 25°C Full-load
- Constant switching frequency (300 kHz)
- Output voltage programmable from 0.75 Vdc to 4.0Vdc via external resistor
- Line Regulation: 0.3% (typical)
- Load Regulation: 0.4% (typical)
- Temperature Regulation: 0.4 % (typical)
- Remote On/Off
- Output overcurrent protection (non-latching)
- Wide operating temperature range (-40°C to 85°C)
- ANSI/UL* 62368-1 and CAN/CSA† C22.2 No. 62368-1 Recognized, DIN VDE‡ 0868-1/A11:2017 (EN62368-1:2014/A11:2017)
- ISO** 9001 and ISO 14001 certified manufacturing facilities

Description

The Austin MicroLynx™ SMT (surface mount technology) power modules are non-isolated dc-dc converters that can deliver up to 5A of output current with full load efficiency of 94.0% at 3.3V output. These modules provide a precisely regulated output voltage programmable via an external resistor from 0.75Vdc to 4.0Vdc over a wide range of input voltage ($V_{IN} = 3.0 - 5.8Vdc$). Their open-frame construction and small footprint enable designers to develop cost- and space-efficient solutions. Standard features include remote On/Off, programmable output voltage, overcurrent and overtemperature protection.

* UL is a registered trademark of Underwriters Laboratories, Inc.

† CSA is a registered trademark of Canadian Standards Association.

‡ VDE is a trademark of Verband Deutscher Elektrotechniker e.V.

** ISO is a registered trademark of the International Organization of Standards

Austin MicroLynx™ 5A: Non-Isolated DC-DC Power Modules

3.0Vdc – 5.8Vdc input; 0.75Vdc to 4.0Vdc output; 5A Output Current

Absolute Maximum Ratings

Stresses in excess of the absolute maximum ratings can cause permanent damage to the device. These are absolute stress ratings only, functional operation of the device is not implied at these or any other conditions in excess of those given in the operations sections of the data sheet. Exposure to absolute maximum ratings for extended periods can adversely affect the device reliability.

Parameter	Device	Symbol	Min	Max	Unit
Input Voltage Continuous	All	V_{IN}	-0.3	5.8	Vdc
Operating Ambient Temperature (see Thermal Considerations section)	All	T_A	-40	85	°C
Storage Temperature	All	T_{stg}	-55	125	°C

Electrical Specifications

Unless otherwise indicated, specifications apply over all operating input voltage, resistive load, and temperature conditions.

Parameter	Device	Symbol	Min	Typ	Max	Unit
Operating Input Voltage	$V_{O,set} \leq V_{IN} - 0.5V$	V_{IN}	3.0	—	5.8	Vdc
Maximum Input Current ($V_{IN} = V_{IN,min}$ to $V_{IN,max}$, $I_O = I_{O,max}$, $V_{O,set} = 3.3Vdc$)	All	$I_{IN,max}$			5.0	Adc
Input No Load Current ($V_{IN} = 5.0Vdc$, $I_O = 0$, module enabled)	$V_{O,set} = 0.75 Vdc$ $V_{O,set} = 3.3Vdc$	$I_{IN,No load}$ $I_{IN,No load}$		20 45		mA mA
Input Stand-by Current ($V_{IN} = 5.0Vdc$, module disabled)	All	$I_{IN,stand-by}$		0.6		mA
Inrush Transient	All	I^2t			0.04	A ² s
Input Reflected Ripple Current, peak-to-peak (5Hz to 20MHz, 1 μ H source impedance; $V_{IN,min}$ to $V_{IN,max}$, $I_O = I_{O,max}$; See Test configuration section)	All			35		mAp-p
Input Ripple Rejection (120Hz)	All			30		dB

CAUTION: This power module is not internally fused. An input line fuse must always be used.

This power module can be used in a wide variety of applications, ranging from simple standalone operation to being part of a complex power architecture. To preserve maximum flexibility, internal fusing is not included, however, to achieve maximum safety and system protection, always use an input line fuse. The safety agencies require a fast-acting fuse with a maximum rating of 6 A (see Safety Considerations section). Based on the information provided in this data sheet on inrush energy and maximum dc input current, the same type of fuse with a lower rating can be used. Refer to the fuse manufacturer's data sheet for further information.

Austin MicroLynx™ 5A: Non-Isolated DC-DC Power Modules

3.0Vdc – 5.8Vdc input; 0.75Vdc to 4.0Vdc output; 5A Output Current

Electrical Specifications (continued)

Parameter	Device	Symbol	Min	Typ	Max	Unit
Output Voltage Set-point ($V_{IN}=V_{IN, min}$, $I_O=I_{O, max}$, $T_A=25^\circ C$)	All	$V_{O, set}$	-2.0	—	+2.0	% $V_{O, set}$
Output Voltage (Over all operating input voltage, resistive load, and temperature conditions until end of life)	All	$V_{O, set}$	-3%	—	+3%	% $V_{O, set}$
Adjustment Range Selected by an external resistor	All	V_O	0.7525		4.0	Vdc
Output Regulation Line ($V_{IN}=V_{IN, min}$ to $V_{IN, max}$) Load ($I_O=I_{O, min}$ to $I_{O, max}$) Temperature ($T_{ref}=T_{A, min}$ to $T_{A, max}$)	All All All		— — —	0.3 0.4 0.4		% $V_{O, set}$ % $V_{O, set}$ % $V_{O, set}$
Output Ripple and Noise on nominal output ($V_{IN}=V_{IN, nom}$ and $I_O=I_{O, min}$ to $I_{O, max}$ $C_{out} = 1\mu F$ ceramic//10 μF tantalum capacitors)						
RMS (5Hz to 20MHz bandwidth)	All		—	10	15	mV _{rms}
Peak-to-Peak (5Hz to 20MHz bandwidth)	All		—	40	50	mV _{pk-pk}
External Capacitance ESR ≥ 1 m Ω ESR ≥ 10 m Ω	All All	$C_{O, max}$ $C_{O, max}$	— —	— —	1000 3000	μF μF
Output Current	All	I_O	0	—	5	A _{dc}
Output Current Limit Inception (Hiccup Mode)	All	$I_{O, lim}$	—	220	—	% I_O
Output Short-Circuit Current ($V_O \leq 250$ mV) (Hiccup Mode)	All	$I_{O, s/c}$	—	2	—	A _{dc}
Efficiency $V_{IN} = V_{IN, nom}$, $T_A=25^\circ C$ $I_O=I_{O, max}$, $V_O = V_{O, set}$	$V_{O, set} = 0.75$ Vdc $V_{O, set} = 1.2$ Vdc $V_{O, set} = 1.5$ Vdc $V_{O, set} = 1.8$ Vdc $V_{O, set} = 2.5$ Vdc $V_{O, set} = 3.3$ Vdc $V_{O, set} = 4.0$ Vdc	η η η η η η η		79.0 85.0 87.0 88.5 92.0 94.0 95.0		% % % % % % %
Switching Frequency	All	f_{sw}	—	300	—	kHz
Dynamic Load Response ($dI_O/dt=2.5$ A/ μs ; $V_{IN} = V_{IN, nom}$; $T_A=25^\circ C$) Load Change from $I_O= 50\%$ to 100% of $I_{O, max}$; 1 μF ceramic// 10 μF tantalum Peak Deviation Settling Time ($V_O < 10\%$ peak deviation)	All	V_{pk}	—	130	—	mV
($dI_O/dt=2.5$ A/ μs ; $V_{IN} = V_{IN, nom}$; $T_A=25^\circ C$) Load Change from $I_O= 100\%$ to 50% of $I_{O, max}$; 1 μF ceramic// 10 μF tantalum Peak Deviation Settling Time ($V_O < 10\%$ peak deviation)	All All	t_s V_{pk}	— —	25 130	— —	μs mV
	All	t_s	—	25	—	μs

Austin MicroLynx™ 5A: Non-Isolated DC-DC Power Modules

3.0Vdc – 5.8Vdc input; 0.75Vdc to 4.0Vdc output; 5A Output Current

Electrical Specifications (continued)

Parameter	Device	Symbol	Min	Typ	Max	Unit
Dynamic Load Response ($dI_o/dt=2.5A/\mu s$; $V_{IN} = V_{IN, nom}$; $T_A=25^\circ C$) Load Change from $I_o= 50\%$ to 100% of $I_{o,max}$; $C_o = 2 \times 150 \mu F$ polymer capacitors Peak Deviation	All	V_{pk}	—	50	—	mV
Settling Time ($V_o < 10\%$ peak deviation) ($dI_o/dt=2.5A/\mu s$; $V_{IN} = V_{IN, nom}$; $T_A=25^\circ C$)	All	t_s	—	50	—	μs
Peak Deviation Load Change from $I_o= 100\%$ to 50% of $I_{o,max}$; $C_o = 2 \times 150 \mu F$ polymer capacitors	All	V_{pk}	—	50	—	mV
Settling Time ($V_o < 10\%$ peak deviation)	All	t_s	—	50	—	μs

General Specifications

Parameter	Min	Typ	Max	Unit
Calculated MTBF ($I_o=I_{o,max}$, $T_A=25^\circ C$)		19,000,000		Hours
Weight	—	2.8 (0.1)	—	g (oz.)

Austin MicroLynx™ 5A: Non-Isolated DC-DC Power Modules

3.0Vdc – 5.8Vdc input; 0.75Vdc to 4.0Vdc output; 5A Output Current

Feature Specifications

Unless otherwise indicated, specifications apply over all operating input voltage, resistive load, and temperature conditions. See Feature Descriptions for additional information.

Parameter	Device	Symbol	Min	Typ	Max	Unit
Remote On/Off Signal interface ($V_{IN}=V_{IN, min}$ to $V_{IN, max}$; Open collector pnp or equivalent Compatible, Von/off signal referenced to GND See feature description section) Logic Low (On/Off Voltage pin open - Module ON)						
Von/Off	All	V_{IL}	—	—	0.4	V
Ion/Off	All	I_{IL}	—	—	10	μA
Logic High (Von/Off > 2.5V - Module Off)						
Von/Off	All	V_{IH}	—	—	V_{IN}	V
Ion/off	All	I_{IH}	—	—	1	mA
Turn-On Delay and Rise Times ($I_o=I_{o, max}$, $V_{IN} = V_{IN, nom}$, $T_A = 25\text{ }^\circ C$,)						
Case 1: On/Off input is set to Logic Low (Module ON) and then input power is applied (delay from instant at which $V_{IN}=V_{IN, min}$ until $V_o=10\%$ of $V_{o, set}$)	All	Tdelay		3.9		msec
Case 2: Input power is applied for at least one second and then the On/Off input is set to logic Low (delay from instant at which Von/Off=0.3V until $V_o=10\%$ of $V_{o, set}$)	All	Tdelay		3.9		msec
Output voltage Rise time (time for V_o to rise from 10% of $V_{o, set}$ to 90% of $V_{o, set}$)	All	Trise	—	4.2	8.5	msec
Output voltage overshoot – Startup $I_o= I_{o, max}$; $V_{IN} = 3.0$ to $5.8Vdc$, $T_A = 25\text{ }^\circ C$				—	1	% $V_{o, set}$
Overtemperature Protection (See Thermal Consideration section)	All	T_{ref}	—	150	—	$^\circ C$
Input Undervoltage Lockout						
Turn-on Threshold	All		—	2.2	—	V
Turn-off Threshold	All		—	2.0	—	V

Austin MicroLynx™ 5A: Non-Isolated DC-DC Power Modules

3.0Vdc – 5.8Vdc input; 0.75Vdc to 4.0Vdc output; 5A Output Current

Characteristic Curves

The following figures provide typical characteristics for the Austin MicroLynx™ SMT modules at 25°C.

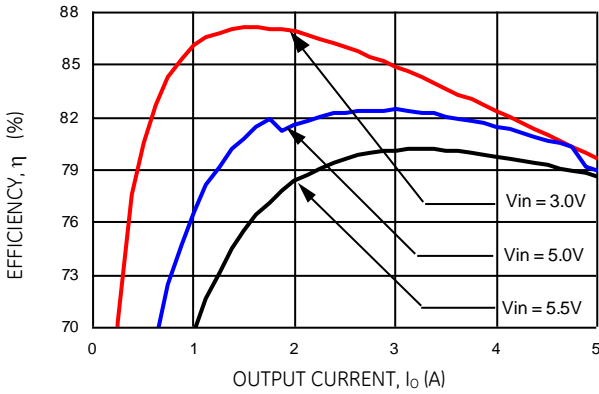

Figure 1. Converter Efficiency versus Output Current (Vout = 0.75Vdc).

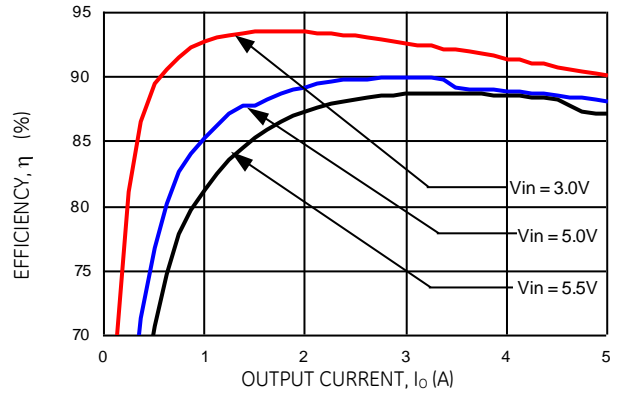

Figure 4. Converter Efficiency versus Output Current (Vout = 1.8Vdc).

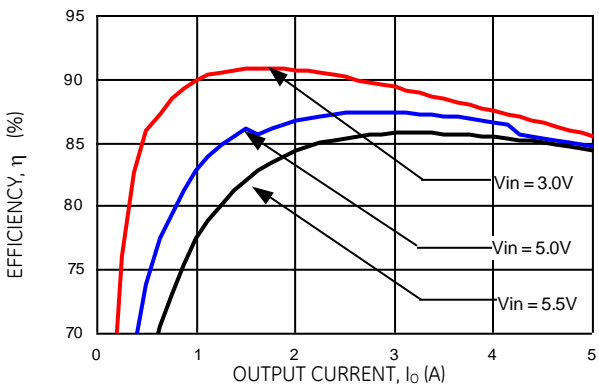

Figure 2. Converter Efficiency versus Output Current (Vout = 1.2Vdc).

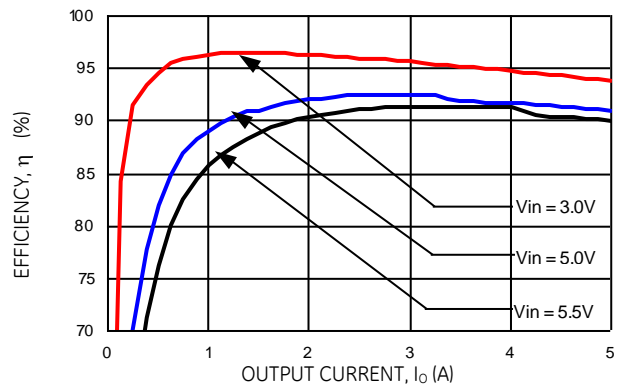

Figure 5. Converter Efficiency versus Output Current (Vout = 2.5Vdc).

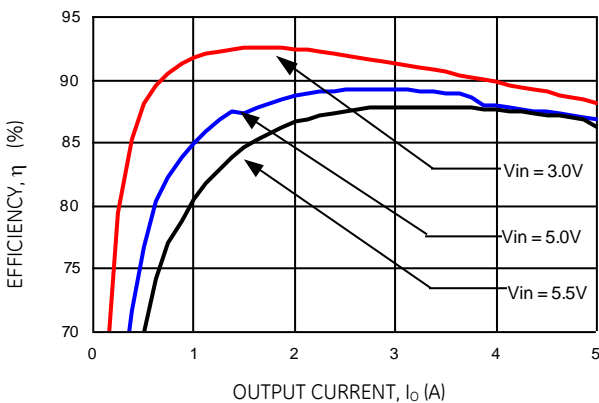

Figure 3. Converter Efficiency versus Output Current (Vout = 1.5Vdc).

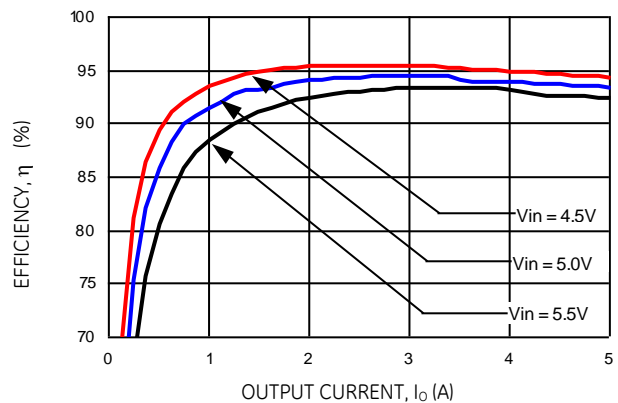

Figure 6. Converter Efficiency versus Output Current (Vout = 3.3Vdc).

Austin MicroLynx™ 5A: Non-Isolated DC-DC Power Modules
 3.0Vdc – 5.8Vdc input; 0.75Vdc to 4.0Vdc output; 5A Output Current

Characteristic Curves

The following figures provide typical characteristics for the Austin MicroLynx™ SMT modules at 25°C.

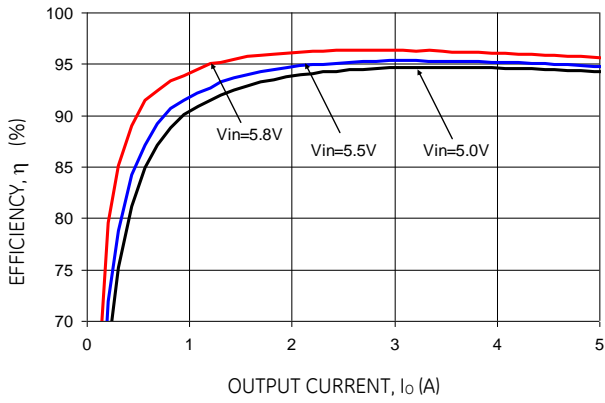

Figure 7. Converter Efficiency versus Output Current ($V_{out} = 4.0Vdc$).

Austin MicroLynx™ 5A: Non-Isolated DC-DC Power Modules

3.0Vdc – 5.8Vdc input; 0.75Vdc to 4.0Vdc output; 5A Output Current

Characteristic Curves (continued)

The following figures provide typical characteristics for the Austin MicroLynx™ SMT modules at 25°C.

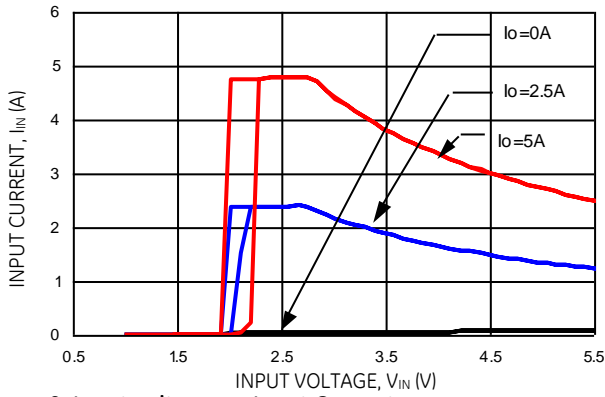

Figure 8. Input voltage vs. Input Current
(Vout = 2.5Vdc).

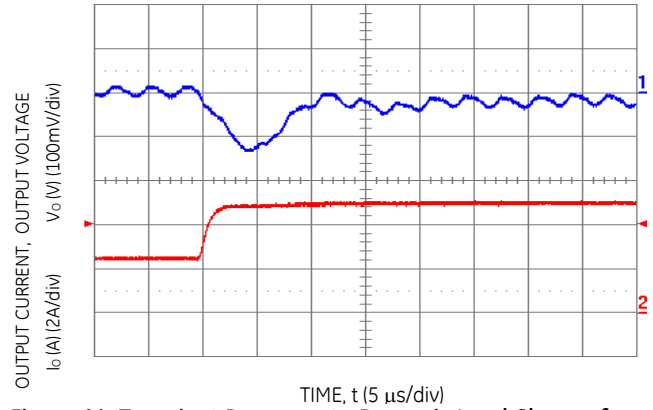

Figure 11. Transient Response to Dynamic Load Change from 50% to 100% of full load (Vo = 3.3Vdc).

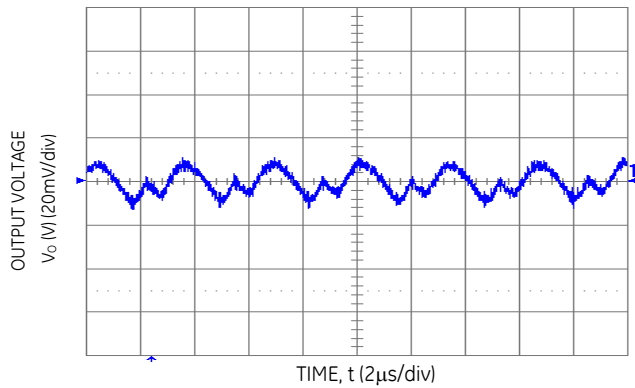

Figure 9. Typical Output Ripple and Noise
(Vin = 5.0V dc, Vo = 0.75 Vdc, Io=5A).

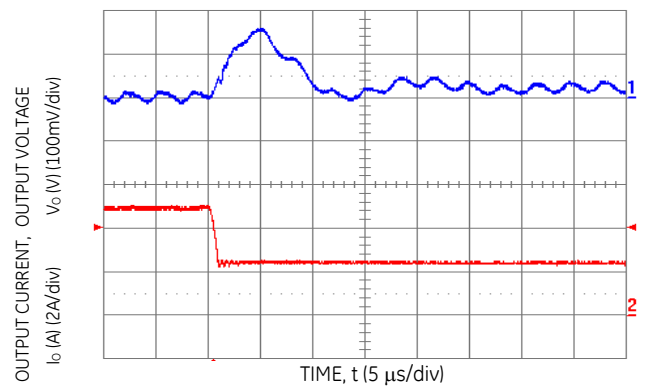

Figure 12. Transient Response to Dynamic Load Change from 100% to 50% of full load (Vo = 3.3 Vdc).

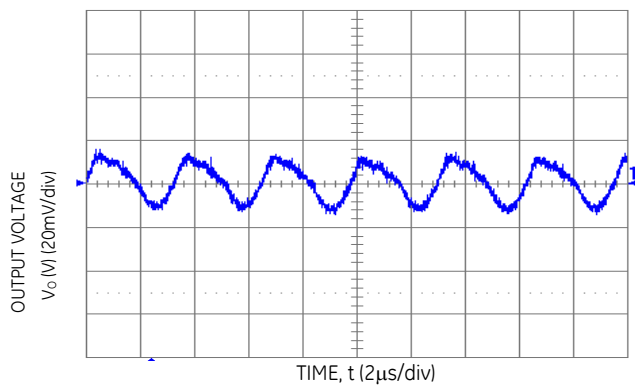

Figure 10. Typical Output Ripple and Noise
(Vin = 5.0V dc, Vo = 3.3 Vdc, Io=5A).

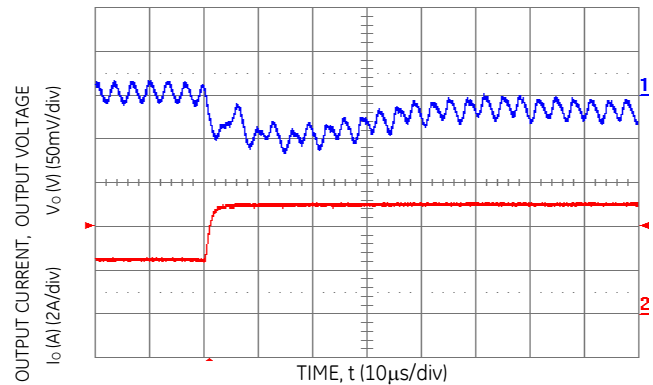

Figure 13. Transient Response to Dynamic Load Change from 50% to 100% of full load (Vo = 5.0 Vdc, Cext = 2x150 μF Polymer Capacitors).

Austin MicroLynx™ 5A: Non-Isolated DC-DC Power Modules

3.0Vdc – 5.8Vdc input; 0.75Vdc to 4.0Vdc output; 5A Output Current

Characteristic Curves (continued)

The following figures provide typical characteristics for the Austin MicroLynx™ SMT modules at 25°C.

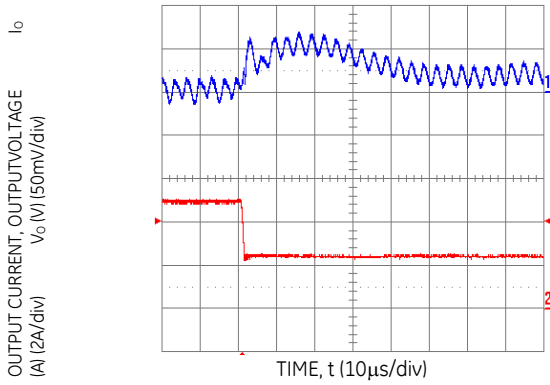

Figure 14. Transient Response to Dynamic Load Change from 100% of 50% full load ($V_o = 5.0\text{ Vdc}$, $C_{ext} = 2 \times 150\ \mu\text{F}$ Polymer Capacitors).

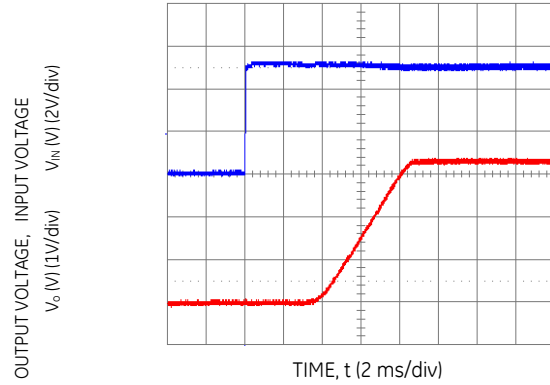

Figure 17. Typical Start-Up with application of V_{in} ($V_{in} = 5.0\text{ Vdc}$, $V_o = 3.3\text{ Vdc}$, $I_o = 5\text{ A}$).

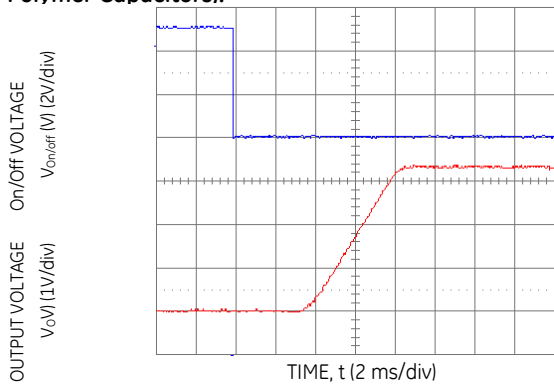

Figure 15. Typical Start-Up Using Remote On/Off ($V_{in} = 5.0\text{ Vdc}$, $V_o = 3.3\text{ Vdc}$, $I_o = 5.0\text{ A}$).

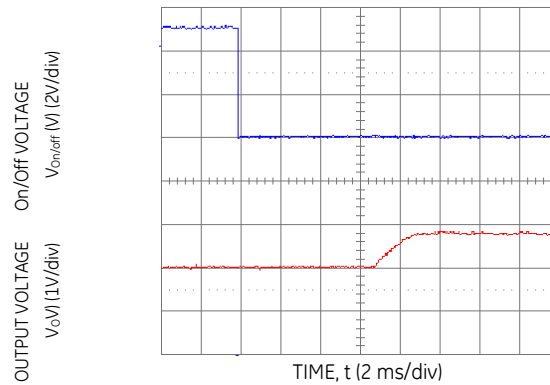

Figure 18. Typical Start-Up Using Remote On/Off with Prebias ($V_{in} = 3.3\text{ Vdc}$, $V_o = 1.8\text{ Vdc}$, $I_o = 1.0\text{ A}$, $V_{bias} = 1.0\text{ Vdc}$).

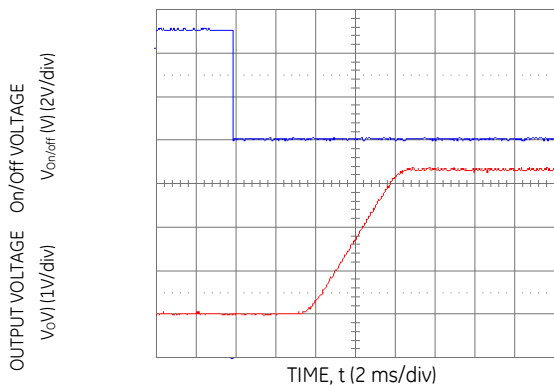

Figure 16. Typical Start-Up Using Remote On/Off with Low-ESR external capacitors ($7 \times 150\ \mu\text{F}$ Polymer) ($V_{in} = 5.0\text{ Vdc}$, $V_o = 3.3\text{ Vdc}$, $I_o = 5.0\text{ A}$, $C_o = 1050\ \mu\text{F}$).

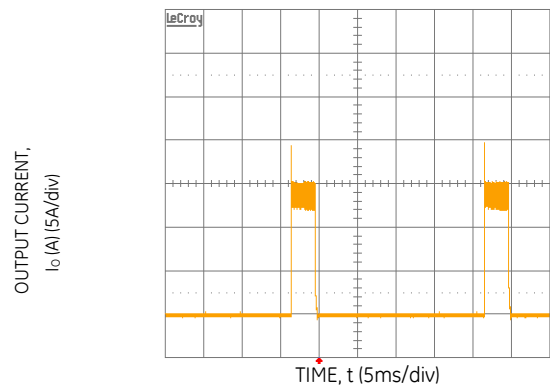

Figure 19. Output short circuit Current ($V_{in} = 5.0\text{ Vdc}$, $V_o = 0.75\text{ Vdc}$).

Austin MicroLynx™ 5A: Non-Isolated DC-DC Power Modules

3.0Vdc – 5.8Vdc input; 0.75Vdc to 4.0Vdc output; 5A Output Current

Characteristic Curves (continued)

The following figures provide thermal derating curves for the Austin MicroLynx™ SMT modules.

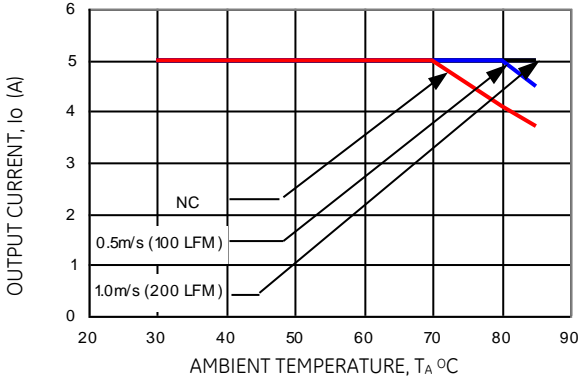

Figure 20. Derating Output Current versus Local Ambient Temperature and Airflow (Vin = 5.0, Vo=3.3Vdc).

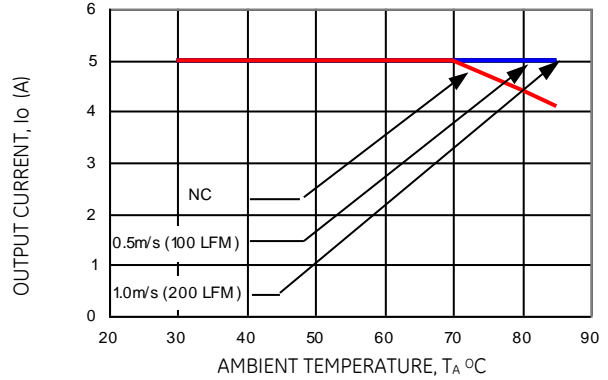

Figure 23. Derating Output Current versus Local Ambient Temperature and Airflow (Vin = 3.3dc, Vo=0.75 Vdc).

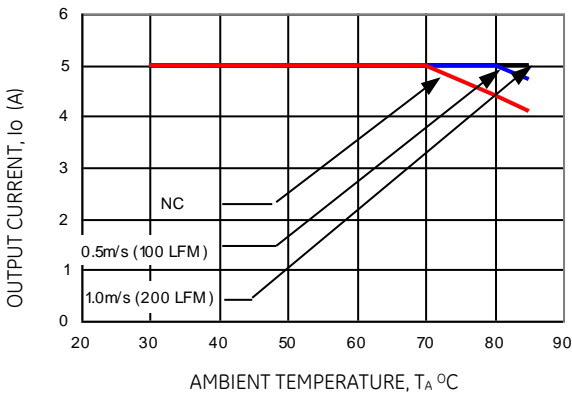

Figure 21. Derating Output Current versus Local Ambient Temperature and Airflow (Vin = 5.0Vdc, Vo=0.75 Vdc).

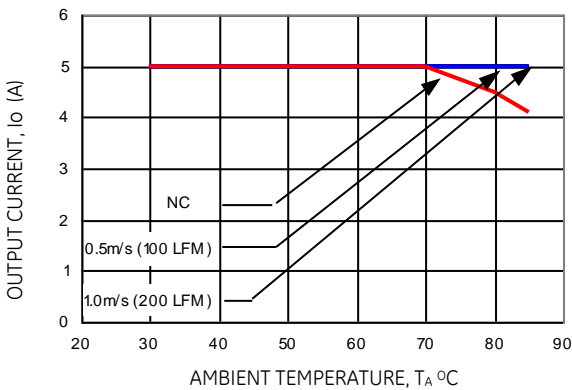
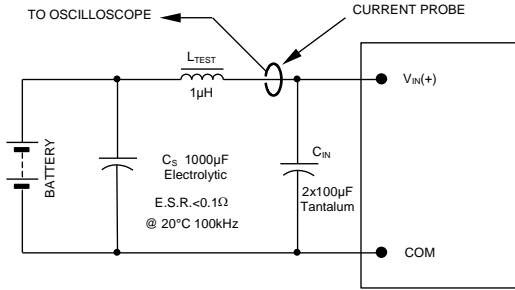

Figure 22. Derating Output Current versus Local Ambient Temperature and Airflow (Vin = 3.3Vdc, Vo=2.5 Vdc).

Austin MicroLynx™ 5A: Non-Isolated DC-DC Power Modules

3.0Vdc – 5.8Vdc input; 0.75Vdc to 4.0Vdc output; 5A Output Current

Test Configurations



NOTE: Measure input reflected ripple current with a simulated source inductance (L_{TEST}) of 1µH. Capacitor C_S offsets possible battery impedance. Measure current as shown above.

Figure 24. Input Reflected Ripple Current Test Setup.

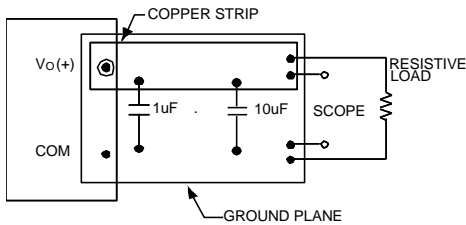

NOTE: All voltage measurements to be taken at the module terminals, as shown above. If sockets are used then Kelvin connections are required at the module terminals to avoid measurement errors due to socket contact resistance.

Figure 25. Output Ripple and Noise Test Setup.

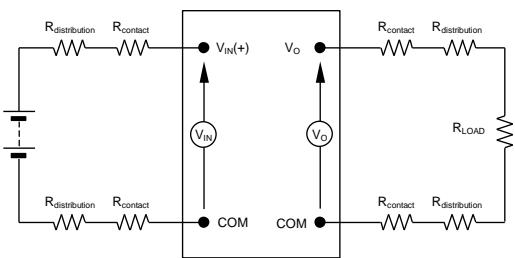

NOTE: All voltage measurements to be taken at the module terminals, as shown above. If sockets are used then Kelvin connections are required at the module terminals to avoid measurement errors due to socket contact resistance.

Figure 26. Output Voltage and Efficiency Test Setup.

$$\text{Efficiency } \eta = \frac{V_O \cdot I_O}{V_{IN} \cdot I_{IN}} \times 100 \%$$

Design Considerations

Input Filtering

The Austin MicroLynx™ SMT module should be connected to a low-impedance source. A highly inductive source can affect the stability of the module. An input capacitance must be placed directly adjacent to the input pin of the module, to minimize input ripple voltage and ensure module stability.

To minimize input voltage ripple, low-ESR polymer and ceramic capacitors are recommended at the input of the module. Figure 27 shows the input ripple voltage (mVp-p) for various outputs with 1x150 µF polymer capacitors (Panasonic p/n: EEFUE0J151R, Sanyo p/n: 6TPE150M) in parallel with 1 x 47 µF ceramic capacitor (Panasonic p/n: ECJ-5YB0J476M, Taiyo-Yuden p/n: CEJMK432BJ476MMT) at full load. Figure 28 shows the input ripple with 2x150 µF polymer capacitors in parallel with 2 x 47 µF ceramic capacitor at full load.

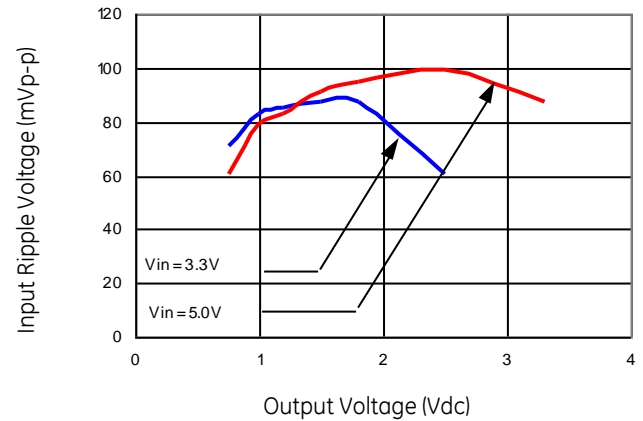

Figure 27. Input ripple voltage for various output with 1x150 µF polymer and 1x47 µF ceramic capacitors at the input (full load).

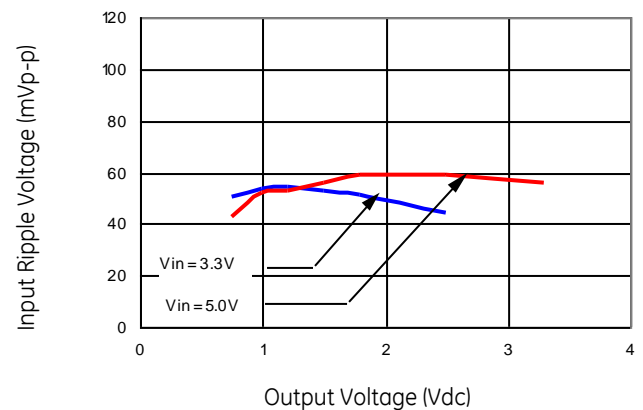

Figure 28. Input ripple voltage for various output with 2x150 µF polymer and 2x47 µF ceramic capacitors at the input (full load).

Austin MicroLynx™ 5A: Non-Isolated DC-DC Power Modules

3.0Vdc –5.8Vdc input; 0.75Vdc to 4.0Vdc output; 5A Output Current

Design Considerations *(continued)*

Output Filtering

The Austin MicroLynx™ SMT module is designed for low output ripple voltage and will meet the maximum output ripple specification with 1 μ F ceramic and 10 μ F tantalum capacitors at the output of the module. However, additional output filtering may be required by the system designer for a number of reasons. First, there may be a need to further reduce the output ripple and noise of the module. Second, the dynamic response characteristics may need to be customized to a particular load step change.

To reduce the output ripple and improve the dynamic response to a step load change, additional capacitance at the output can be used. Low ESR polymer and ceramic capacitors are recommended to improve the dynamic response of the module. For stable operation of the module, limit the capacitance to less than the maximum output capacitance as specified in the electrical specification table.

Safety Considerations

For safety agency approval the power module must be installed in compliance with the spacing and separation requirements of the end-use safety agency standards, i.e., UL ANSI/UL* 62368-1 and CAN/CSA+ C22.2 No. 62368-1 Recognized, DIN VDE 0868-1/A11:2017 (EN62368-1:2014/A11:2017)

For the converter output to be considered meeting the Requirements of safety extra-low voltage (SELV) or ES1, the input must meet SELV/ES1 requirements. The power module has extra-low voltage (ELV) outputs when all inputs are ELV.

The input to these units is to be provided with a fast-acting fuse with a maximum rating of 6A in the positive input lead.

Austin MicroLynx™ 5A: Non-Isolated DC-DC Power Modules

3.0Vdc – 5.8Vdc input; 0.75Vdc to 4.0Vdc output; 5A Output Current

Feature Description

Remote On/Off

The Austin MicroLynx™ SMT power modules feature an On/Off pin for remote On/Off operation of the module. If not using the remote On/Off pin, leave the pin open (module will be On). The On/Off pin signal ($V_{On/Off}$) is referenced to ground. To switch the module on and off using remote On/Off, connect an open collector pnp transistor between the On/Off pin and the V_{IN} pin (See Figure 29).

When the transistor Q1 is in the OFF state, the power module is ON (Logic Low on the On/Off of the module) and the maximum $V_{On/off}$ of the module is 0.4 V. The maximum allowable leakage current of the transistor when $V_{On/off} = 0.4$ V and $V_{IN} = V_{IN,max}$ is $10\mu A$. During a logic-high when the transistor is in the active state, the power module is OFF. During this state $V_{On/Off} = 2.5$ V to 5.8V and the maximum $I_{On/Off} = 1$ mA.

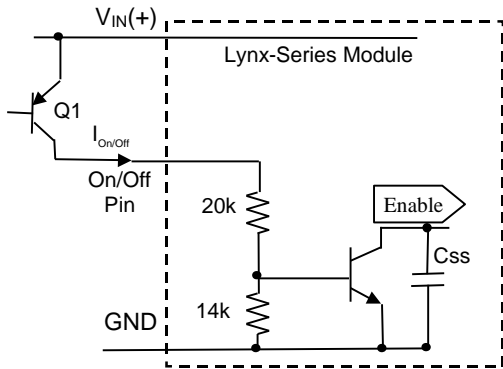

Figure 29. Remote On/Off Implementation.

Remote On/Off can also be implemented using open-collector logic devices with an external pull-up resistor. Figure 30 shows the circuit configuration using this approach. Pull-up resistor $R_{pull-up}$, for the configuration should be 5k (+/- 5%) for proper operation of module over the entire temperature range.

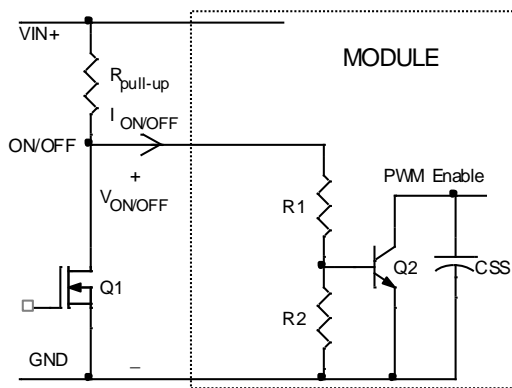

Figure 30. Remote On/Off Implementation using logic-level devices and an external pull-up resistor.

Overcurrent Protection

To provide protection in a fault (output overload) condition, the unit is equipped with internal current-limiting circuitry and can endure current limiting continuously. At the point of current-limit inception, the unit enters hiccup mode. The unit operates normally once the output current is brought back into its specified range. The typical average output current during hiccup is 2A.

Input Undervoltage Lockout

At input voltages below the input undervoltage lockout limit, module operation is disabled. The module will begin to operate at an input voltage above the undervoltage lockout turn-on threshold.

Overtemperature Protection

To provide over temperature protection in a fault condition, the unit relies upon the thermal protection feature of the controller IC. The unit will shutdown if the thermal reference point T_{ref} , exceeds 150°C (typical), but the thermal shutdown is not intended as a guarantee that the unit will survive temperatures beyond its rating. The module will automatically restart after it cools down.

Austin MicroLynx™ 5A: Non-Isolated DC-DC Power Modules

3.0Vdc –5.8Vdc input; 0.75Vdc to 4.0Vdc output; 5A Output Current

Feature Descriptions (continued)

Output Voltage Programming

The output voltage of the Austin MicroLynx™ SMT can be programmed to any voltage from 0.75 Vdc to 4.0 Vdc by connecting a single resistor (shown as R_{trim} in Figure 31) between the TRIM and GND pins of the module. Without an external resistor between TRIM pin and the ground, the output voltage of the module is 0.75 Vdc. To calculate the value of the resistor R_{trim} for a particular output voltage V_o , use the following equation:

$$R_{trim} = \left[\frac{21070}{V_o - 0.7525} - 5110 \right] \Omega$$

For example, to program the output voltage of the Austin MicroLynx™ module to 1.8 Vdc, R_{trim} is calculated as follows:

$$R_{trim} = \left[\frac{21070}{1.8 - 0.7525} - 5110 \right]$$

$$R_{trim} = 15.004k\Omega$$

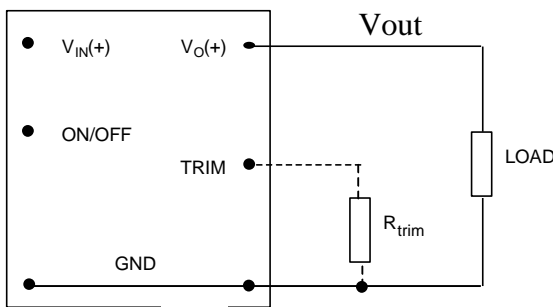

Figure 31. Circuit configuration for programming output voltage using an external resistor.

The Austin MicroLynx™ can also be programmed by applying a voltage between the TRIM and the GND pins (Figure 32). The following equation can be used to determine the value of V_{trim} needed to obtain a desired output voltage V_o :

$$V_{trim} = (0.7 - 0.1698 \times \{V_o - 0.7525\})$$

For example, to program the output voltage of a MicroLynx™ module to 3.3 Vdc, V_{trim} is calculated as follows:

$$V_{trim} = (0.7 - 0.1698 \times \{3.3 - 0.7525\})$$

$$V_{trim} = 0.2670V$$

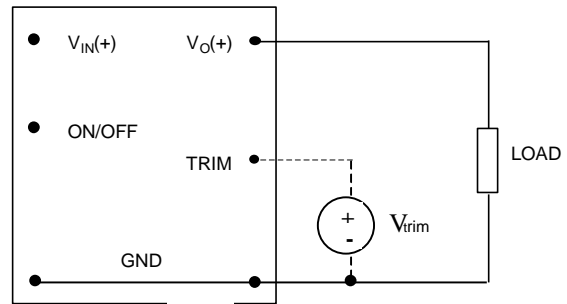

Figure 32. Circuit Configuration for programming Output voltage using external voltage source.

Table 1 provides R_{trim} values required for some common output voltages, while Table 2 provides values of the external voltage source, V_{trim} for the same common output voltages.

Table 1

$V_{o, set}$ (V)	R_{trim} (K Ω)
0.7525	Open
1.2	41.973
1.5	23.077
1.8	15.004
2.5	6.947
3.3	3.160

Table 2

$V_{o, set}$ (V)	V_{trim} (V)
0.7525	Open
1.2	0.6240
1.5	0.5731
1.8	0.5221
2.5	0.4033
3.3	0.2674

By using a 1% tolerance trim resistor, set point tolerance of $\pm 2\%$ is achieved as specified in the electrical specification. The POL Programming Tool, available at www.lineagepower.com under the Design Tools section, helps determine the required external trim resistor needed for a specific output voltage.

Austin MicroLynx™ 5A: Non-Isolated DC-DC Power Modules

3.0Vdc –5.8Vdc input; 0.75Vdc to 4.0Vdc output; 5A Output Current

Feature Description (continued)

Voltage Margining

Output voltage margining can be implemented in the Austin MicroLynx™ modules by connecting a resistor, $R_{margin-up}$, from the Trim pin to the ground pin for margining-up the output voltage and by connecting a resistor, $R_{margin-down}$, from the Trim pin to the Output pin for margining-down. Figure 31 shows the circuit configuration for output voltage margining. The POL Programming Tool, available at www.lineagepower.com under the Design Tools section, also calculates the values of $R_{margin-up}$ and $R_{margin-down}$ for a specific output voltage and % margin. Please consult your local GE technical representative for additional details.

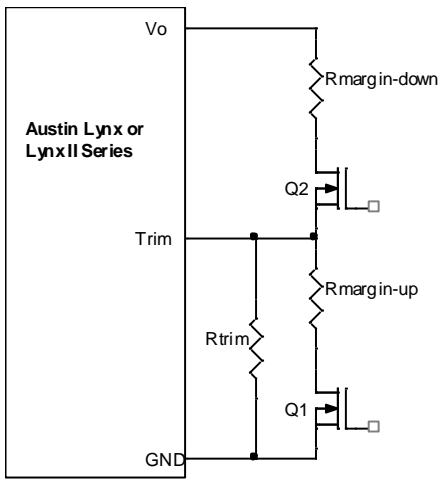

Figure 33. Circuit Configuration for margining Output voltage.

Austin MicroLynx™ 5A: Non-Isolated DC-DC Power Modules

3.0Vdc – 5.8Vdc input; 0.75Vdc to 4.0Vdc output; 5A Output Current

Thermal Considerations

Power modules operate in a variety of thermal environments; however, sufficient cooling should always be provided to help ensure reliable operation.

Considerations include ambient temperature, airflow, module power dissipation, and the need for increased reliability. A reduction in the operating temperature of the module will result in an increase in reliability. The thermal data presented here is based on physical measurements taken in a wind tunnel. Note that the airflow is parallel to the long axis of the module as shown in figure 34. The test set-up is shown in figure 35. The derating data applies to airflow in either direction of the module's long axis.

The thermal reference point, T_{ref} used in the specifications is shown in Figure 34. For reliable operation this temperature should not exceed 115°C.

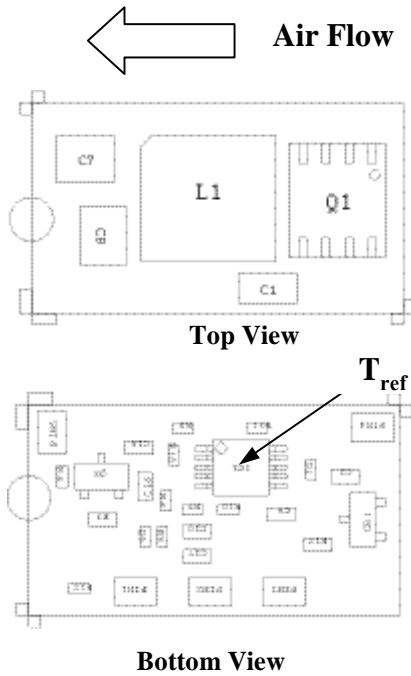

Figure 34. T_{ref} Temperature measurement location.

The output power of the module should not exceed the rated power of the module ($V_{o,set} \times I_{o,max}$).

Please refer to the Application Note “Thermal Characterization Process For Open-Frame Board-Mounted Power Modules” for a detailed discussion of thermal aspects including maximum device temperatures.

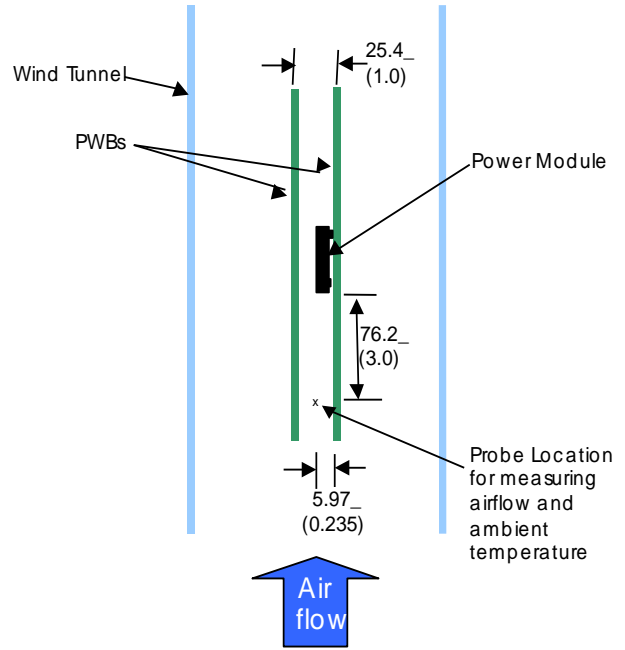

Figure 35. Thermal Test Set-up.

Heat Transfer via Convection

Increased airflow over the module enhances the heat transfer via convection. Thermal derating curves showing the maximum output current that can be delivered at different local ambient temperatures (T_A) for airflow conditions ranging from natural convection and up to 1m/s (200 ft./min) are shown in the Characteristics Curves section.

Austin MicroLynx™ 5A: Non-Isolated DC-DC Power Modules

3.0Vdc –5.8Vdc input; 0.75Vdc to 4.0Vdc output; 5A Output Current

Mechanical Outline

Dimensions are in millimeters and (inches).

Tolerances: x.x mm ± 0.5 mm (x.xx in. ± 0.02 in.) [unless otherwise indicated]

x.xx mm ± 0.25 mm (x.xxx in ± 0.010 in.)

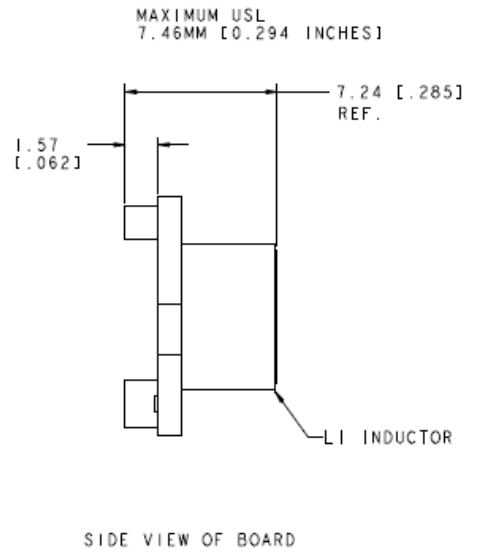
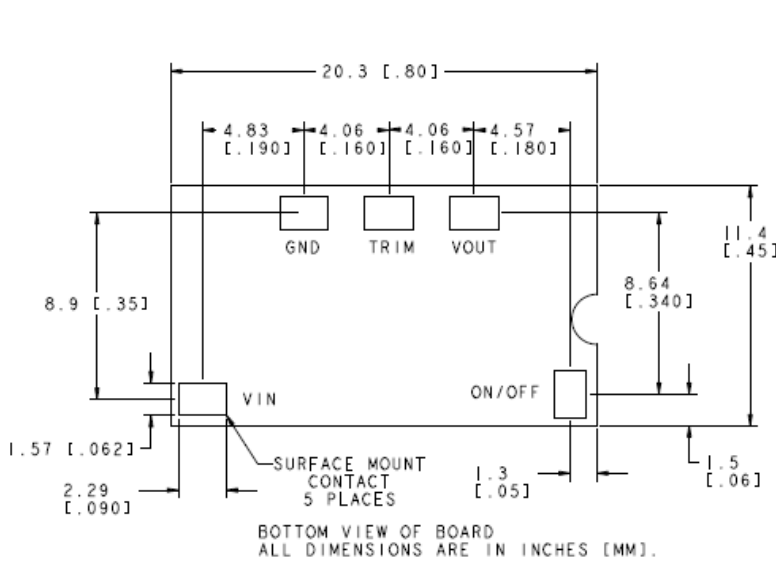

Austin MicroLynx™ 5A: Non-Isolated DC-DC Power Modules

3.0Vdc – 5.8Vdc input; 0.75Vdc to 4.0Vdc output; 5A Output Current

Recommended Pad Layout

Dimensions are in millimeters and (inches).

Tolerances: x.x mm ± 0.5 mm (x.xx in. ± 0.02 in.) [unless otherwise indicated]

x.xx mm ± 0.25 mm (x.xxx in ± 0.010 in.)

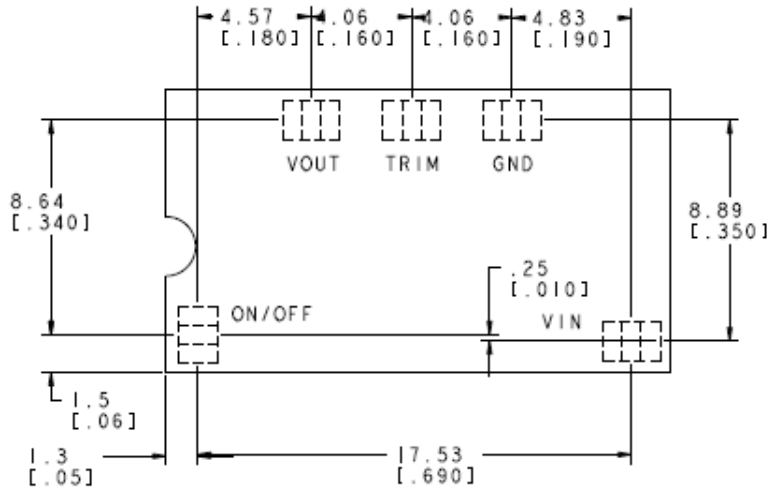

RECOMMENDED PAD LAYOUT
 PAD SIZE:
 MIN: 0.120" X 0.095"
 MAX: 0.135" X 0.110"
 ALL DIMENSIONS ARE IN MM and [INCHES]

Austin MicroLynx™ 5A: Non-Isolated DC-DC Power Modules

3.0Vdc –5.8Vdc input; 0.75Vdc to 4.0Vdc output; 5A Output Current

Packaging Details

The Austin MicroLynx™ SMT version is supplied in tape & reel as standard. Modules are shipped in quantities of 500 modules per reel.

All Dimensions are in millimeters and (in inches).

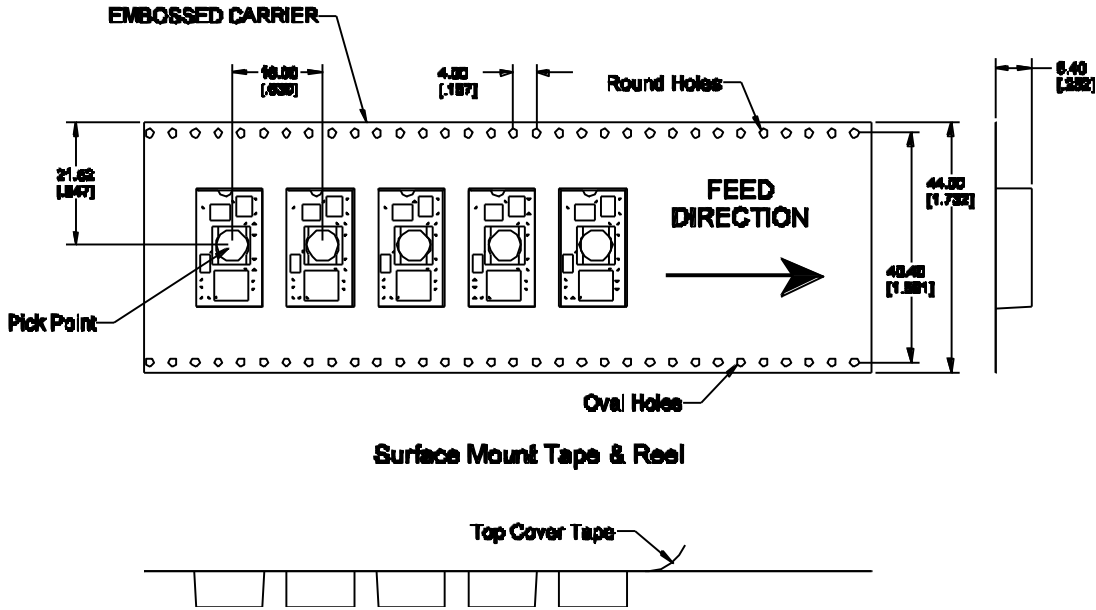

Reel Dimensions:

Outside Dimensions: 330.2 mm (13.00)

Inside Dimensions: 177.8 mm (7.00")

Tape Width: 44.00 mm (1.732")

Austin MicroLynx™ 5A: Non-Isolated DC-DC Power Modules

3.0Vdc – 5.8Vdc input; 0.75Vdc to 4.0Vdc output; 5A Output Current

Surface Mount Information

Pick and Place

The Austin MicroLynx™ SMT modules use an open frame construction and are designed for a fully automated assembly process. The modules are fitted with a label designed to provide a large surface area for pick and place operations. The label meets all the requirements for surface mount processing, as well as safety standards, and is able to withstand reflow temperatures of up to 300°C. The label also carries product information such as product code, serial number and the location of manufacture.

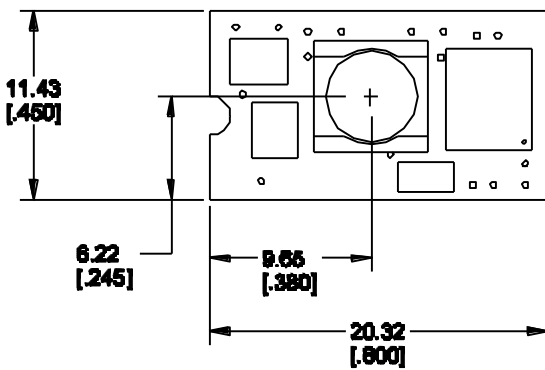

All dimensions are in millimeters and (inches).

Figure 36. Pick and Place Location.

Nozzle Recommendations

The module weight has been kept to a minimum by using open frame construction. Even so, these modules have a relatively large mass when compared to conventional SMT components. Variables such as nozzle size, tip style, vacuum pressure and placement speed should be considered to optimize this process. The minimum recommended nozzle diameter for reliable operation is 6mm. The maximum nozzle outer diameter, which will safely fit within the allowable component spacing, is 9 mm.

Oblong or oval nozzles up to 11 x 9 mm may also be used within the space available.

Reflow Soldering Information

The Austin MicroLynx™ SMT power modules are large mass, low thermal resistance devices and typically heat up slower than other SMT components. It is recommended that the customer review data sheets in order to customize the solder reflow profile for each application board assembly. The following instructions must be observed when soldering these units. Failure to observe these instructions may result in the failure of or cause damage to the modules, and can adversely affect long-term reliability.

Typically, the eutectic solder melts at 183°C, wets the land, and subsequently wicks the device connection. Sufficient time must be allowed to fuse the plating on the connection to ensure a reliable solder joint. There are several types of SMT reflow technologies currently used in the industry. These surface mount power modules can be reliably soldered using natural forced convection, IR (radiant infrared), or a combination of convection/IR. For reliable soldering the solder reflow profile should be established by accurately measuring the modules pin temperatures.

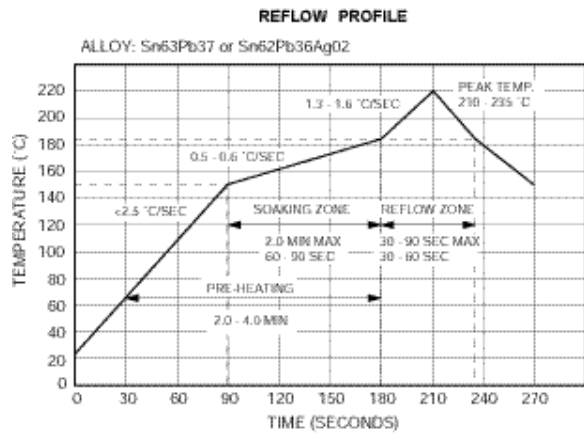

Figure 37. Reflow Profile.

An example of a reflow profile (using 63/37 solder) for the Austin MicroLynx™ SMT power module is :

- Pre-heating zone: room temperature to 183°C (2.0 to 4.0 minutes maximum)
- Initial ramp rate < 2.5°C per second
- Soaking Zone: 155 °C to 183 °C – 60 to 90 seconds typical (2.0 minutes maximum)
- Reflow zone ramp rate: 1.3°C to 1.6°C per second
- Reflow zone: 210°C to 235°C peak temperature – 30 to 60 seconds (90 seconds maximum)

Austin MicroLynx™ 5A: Non-Isolated DC-DC Power Modules

3.0Vdc –5.8Vdc input; 0.75Vdc to 4.0Vdc output; 5A Output Current

Surface Mount Information (continued)

Lead Free Soldering

The –Z version Austin MicroLynx SMT modules are lead-free (Pb-free) and RoHS compliant and are both forward and backward compatible in a Pb-free and a SnPb soldering process. Failure to observe the instructions below may result in the failure of or cause damage to the modules and can adversely affect long-term reliability.

Pb-free Reflow Profile

Power Systems will comply with J-STD-020 Rev. C (Moisture/Reflow Sensitivity Classification for Nonhermetic Solid State Surface Mount Devices) for both Pb-free solder profiles and MSL classification procedures. This standard provides a recommended forced-air-convection reflow profile based on the volume and thickness of the package (table 4-2). The suggested Pb-free solder paste is Sn/Ag/Cu (SAC). The recommended linear reflow profile using Sn/Ag/Cu solder is shown in Fig. 38.

MSL Rating

The Austin MicroLynx SMT modules have a MSL rating of 2a.

Storage and Handling

The recommended storage environment and handling procedures for moisture-sensitive surface mount packages is detailed in J-STD-033 Rev. A (Handling, Packing, Shipping and Use of Moisture/Reflow Sensitive Surface Mount Devices). Moisture barrier bags (MBB) with desiccant are required for MSL ratings of 2 or greater. These sealed packages should not be broken until time of

use. Once the original package is broken, the floor life of the product at conditions of $\leq 30^{\circ}\text{C}$ and 60% relative humidity varies according to the MSL rating (see J-STD-033A). The shelf life for dry packed SMT packages will be a minimum of 12 months from the bag seal date, when stored at the following conditions: $< 40^{\circ}\text{C}$, $< 90\%$ relative humidity.

Post Solder Cleaning and Drying Considerations

Post solder cleaning is usually the final circuit-board assembly process prior to electrical board testing. The result of inadequate cleaning and drying can affect both the reliability of a power module and the testability of the finished circuit-board assembly. For guidance on appropriate soldering, cleaning and drying procedures, refer to *Board Mounted Power Modules: Soldering and Cleaning* Application Note (AN04-001).

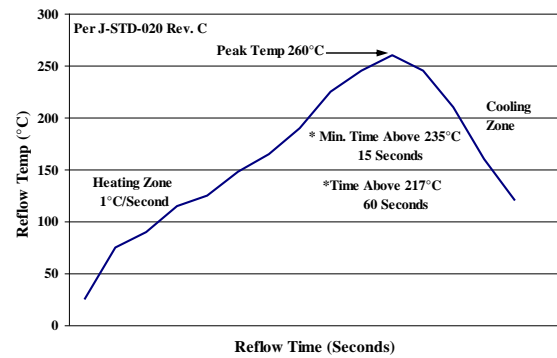

Figure 38. Recommended linear reflow profile using Sn/Ag/Cu solder.

Austin MicroLynx™ 5A: Non-Isolated DC-DC Power Modules

3.0Vdc – 5.8Vdc input; 0.75Vdc to 4.0Vdc output; 5A Output Current

Ordering Information

Please contact your GE Sales Representative for pricing, availability and optional features.

Table 3. Device Codes

Product codes	Input Voltage	Output Voltage	Output Current	Efficiency 3.3V @ 5A	Connector Type	Comcode
AXH005A0X-SRZ	3.0 – 5.8 Vdc	0.75 – 4.0 Vdc	5A	94.0%	SMT	109100518

-Z refers to RoHS-compliant parts

Contact Us

For more information, call us at

USA/Canada:

+1 888 546 3243, or +1 972 244 9288

Asia-Pacific:

+86-21-53899666

Europe, Middle-East and Africa:

+49.89.878067-280

[Go.ABB/Industrial](#)



GE Critical Power reserves the right to make changes to the product(s) or information contained herein without notice, and no liability is assumed as a result of their use or application. No rights under any patent accompany the sale of any such product(s) or information.