

Xinger®

Ultra Low Profile 0805 3 dB, 90° Hybrid Coupler

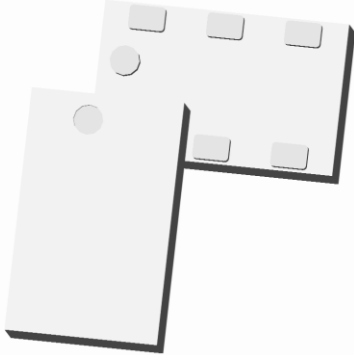

Description

The C0810J5003AHF is a low cost, low profile sub-miniature high performance 3 dB coupler in an easy to use surface mount package. It is designed for 800 – 1000MHz applications including: GSM, WCDMA, CDMA and 900MHz ISM applications. The C0810J5003AHF is ideal for balanced power and low noise amplifiers, plus signal distribution and other applications where low insertion loss and tight amplitude and phase balance are required. The C0810J5003AHF is available on tape and reel for pick and place high volume manufacturing.

All of the Xinger components are constructed from ceramic filled PTFE composites which possess excellent electrical and mechanical stability. All parts have been subjected to rigorous qualification testing and units are 100% RF tested.

Detailed Electrical Specifications: Specifications subject to change without notice.

Features:	Parameter	Extended Band			Nominal Band			25°C
		Min	Typ	Max	Min	Typ	Max	Unit
		<ul style="list-style-type: none"> 800 – 1000 MHz 0.68 mm Height Profile LTE Bands: 5,6,8,12,13,14, 17, 18, 19, 20 GSM, WCDMA & 900 MHz ISM Surface Mountable Tape & Reel RoHS Compliant Halogen-Free 	Frequency	700		1000	800	
Port Impedance		50			50			Ω
	Return Loss	18	28		21	31		Ω
	Isolation	18	21		18	23		dB
	Insertion Loss*		0.5	0.6		0.5	0.6	dB
	Amplitude Balance		0.6	0.9		0.6	0.9	dB
	Phase Balance		4	7		4	7	Degrees
	Power Handling @85C			4			4	Watts
	Power Handling @105C			3			3	Watts
	Operating Temperature	-55		+105	-55		+105	°C
	Group Delay (0.7-1.0GHz) (nSec)	Min.			Typ.			Max.
		0.20			0.24			0.28

Outline Drawing

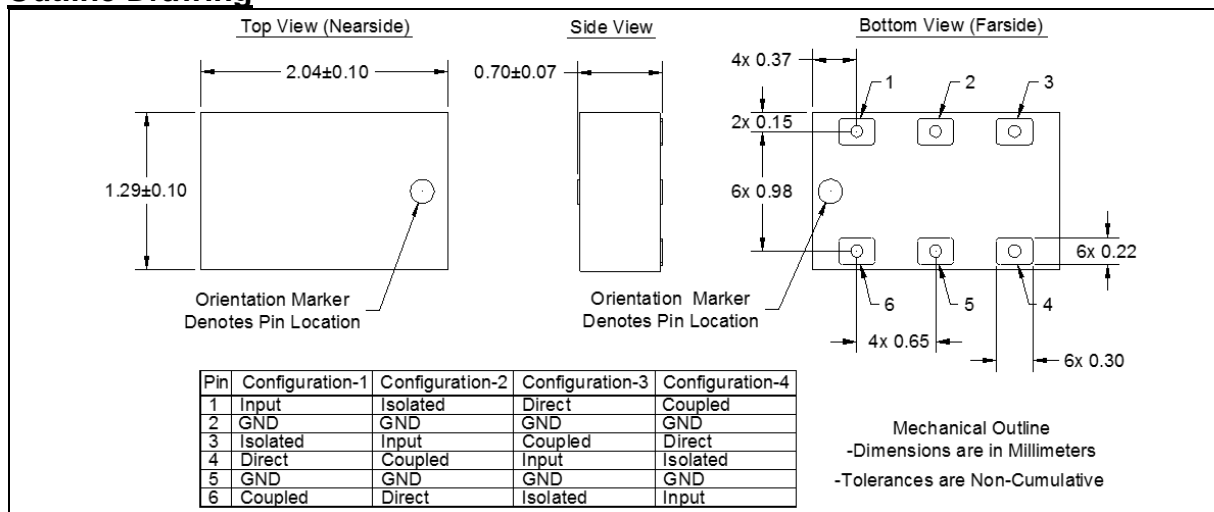

Typical Broadband Performance: 500 MHz. to 8000 MHz.

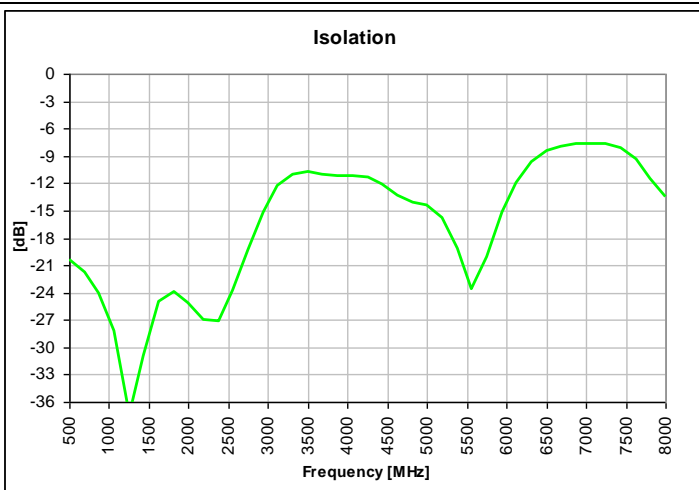
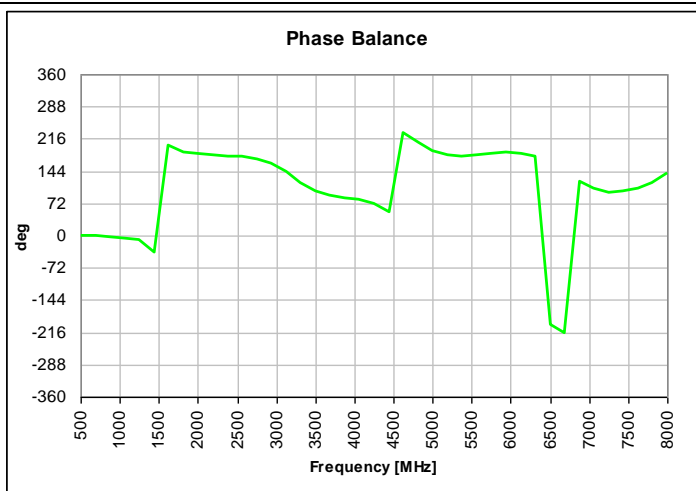
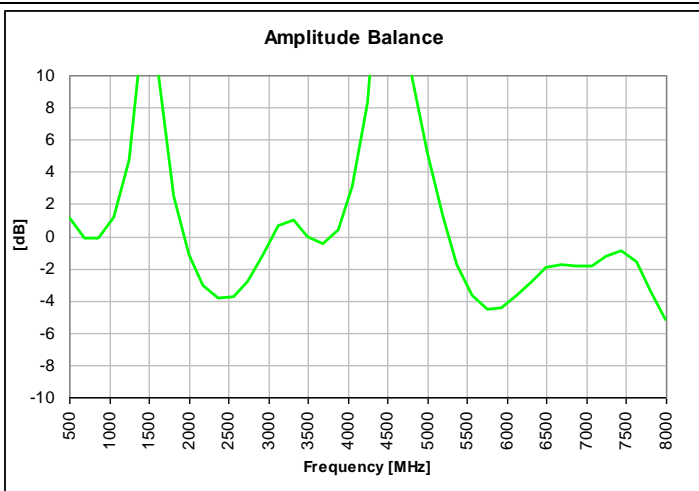
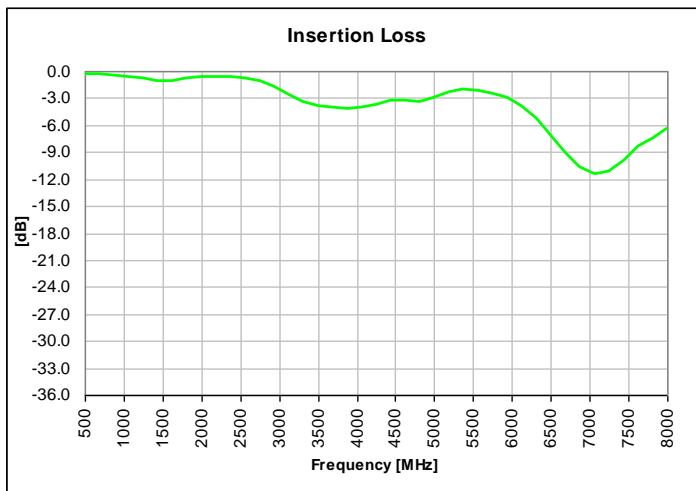
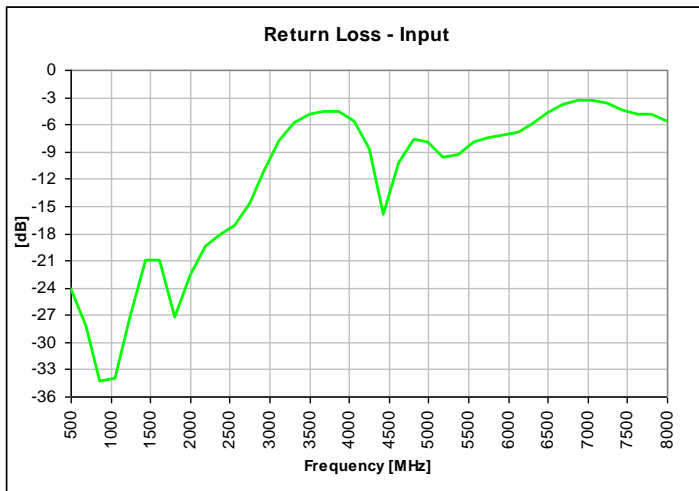

Typical Performance: 700 MHz. to 1100 MHz.

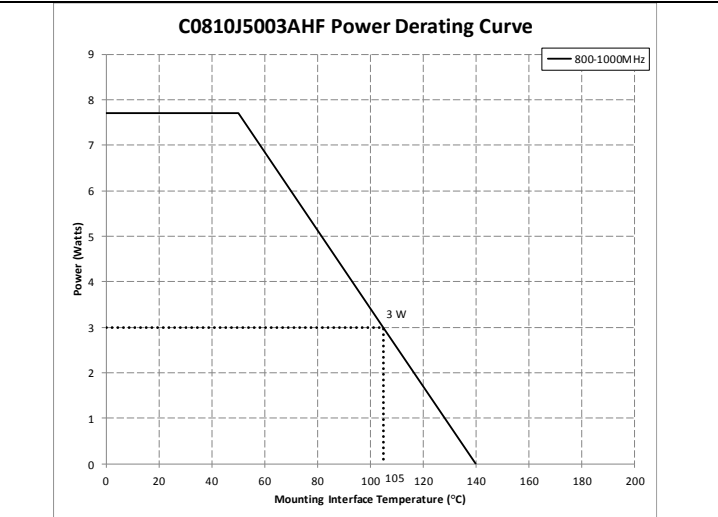
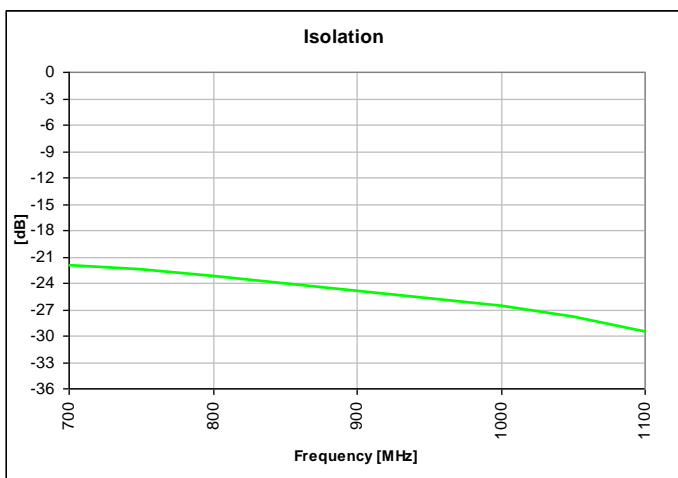
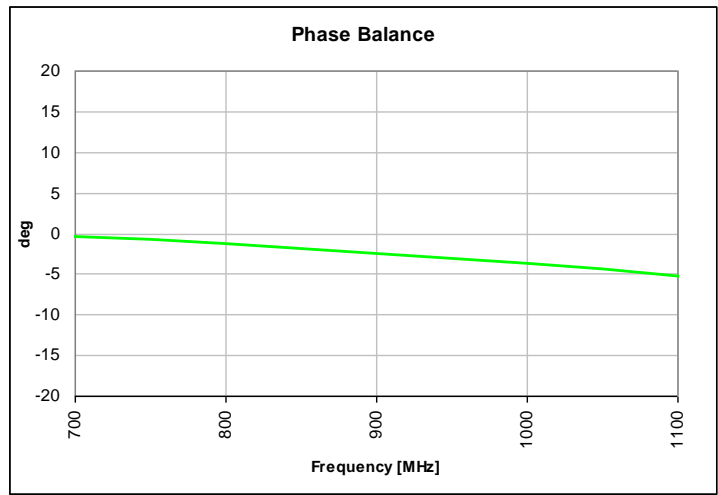
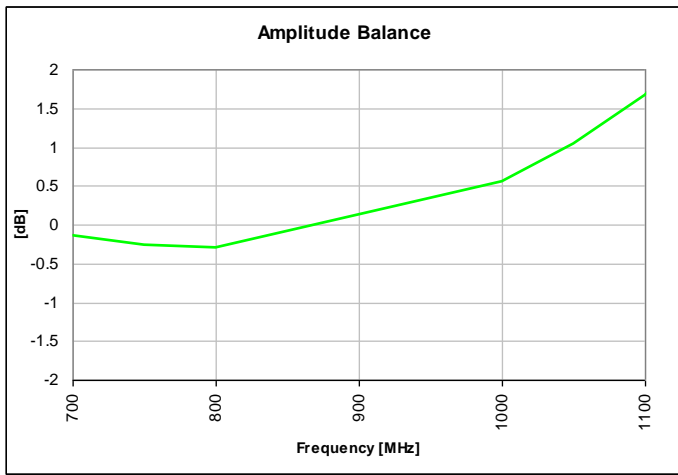
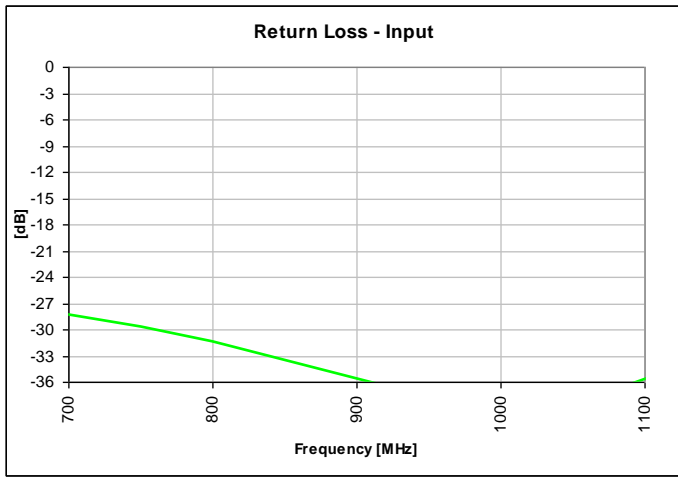

Definition of Measured Specifications

Parameter	Definition	Mathematical Representation <i>i, j, k, m</i> is denoted as the port index of input, isolated, direct and coupled port for specific pin configuration shown in the table
Return Loss	The impedance match of the coupler to a 50Ω system. Return Loss is an alternate means to express VSWR.	$20\log_{10}(S_{ii})$
Isolation	The input power divided by the sum of the power at the two output ports.	$20\log_{10} S_{ji} $
Insertion Loss	The input power divided by the sum of the power at the two output ports.	$10\log_{10}(S_{mi} ^2 + S_{ki} ^2)$
Amplitude Balance	The difference in power between the two outputs.	$20\log_{10}\left(\frac{ S_{ki} }{ S_{mi} }\right)$
Phase Balance	The difference in phase angle between the two output ports.	$\angle S_{ki} - \angle S_{mi} + 90^\circ$

*100% RF test is performed per spec definition for pin configuration 1 and port 1 (input port) is connected to pin1, port 2 (isolated port) is connected to pin 3, port 3 (direct port) is connected to pin 4 and port 4 (isolated) is connected to pin 6.

Mounting Configuration:

In order for Xinger surface mount components to work optimally, the proper impedance transmission lines must be used to connect to the RF ports. If this condition is not satisfied, insertion loss, Isolation and VSWR may not meet published specifications.

All of the Xinger components are constructed from organic PTFE based composites which possess excellent electrical and mechanical stability. Xinger components are compliant to a variety of ROHS and Green standards and ready for Pb-free soldering processes. Pads are Gold plated with a Nickel barrier.

An example of the PCB footprint used in the testing of these parts is shown below. In specific designs, the transmission line widths need to be adjusted to the unique dielectric coefficients and thicknesses as well as varying pick and place equipment tolerances.

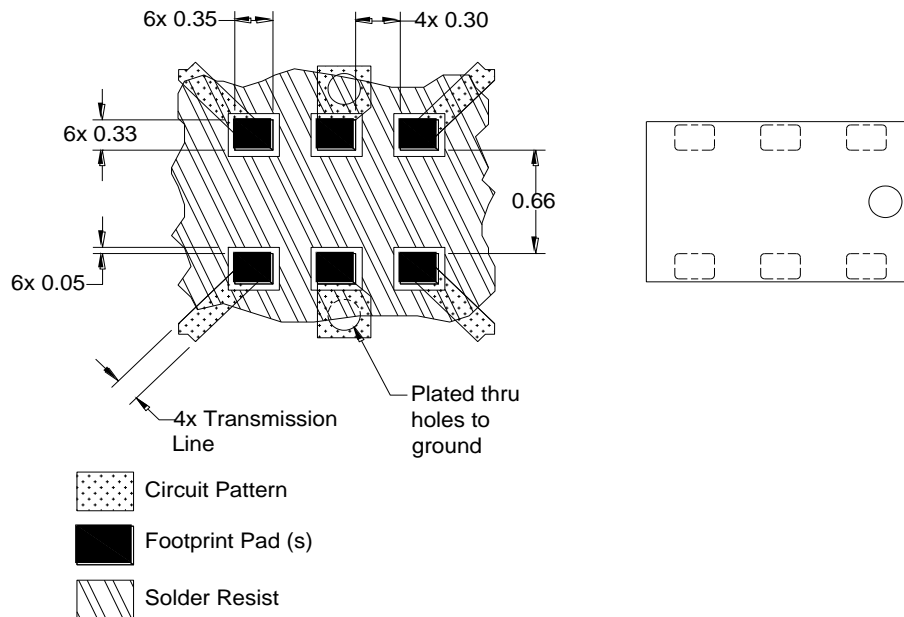

Dimensions are in Millimeters
Mounting Footprint

Packaging and Ordering Information

Parts are available in reel and are packaged per EIA 481-D. Parts are oriented in tape and reel as shown below. Minimum order quantities are 4000 per reel.

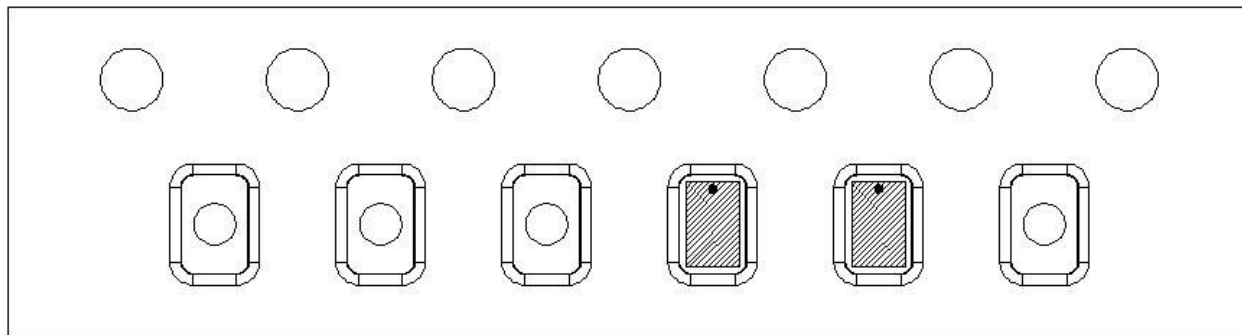

Direction of
Part Feed
(Unloading) 

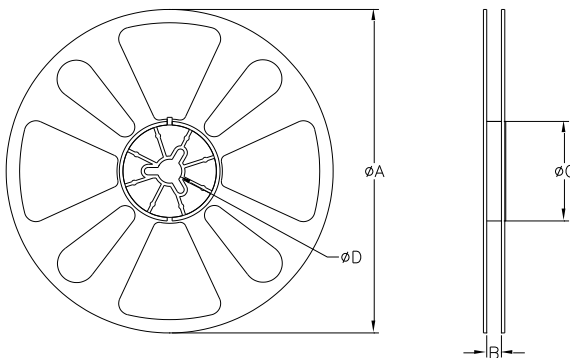

TABLE 1		
QUANTITY/REEL	REEL DIMENSIONS mm	
4000	ϕA	177.80
	B	8.00
	ϕC	50.80
	ϕD	13.00