

Features

- $BV_{CEO} > -100V$
- $I_C = -3.5A$ High Continuous Current
- $R_{SAT} = 57m\Omega$ for a Low Equivalent On-Resistance
- Low Saturation Voltage $V_{CE(SAT)} < -85mV @ I_C = -1A$
- h_{FE} Specified Up to $-10A$ for High Current Gain Hold Up
- Complementary NPN Type: ZXTN2011Z
- **Lead-Free Finish; RoHS Compliant (Notes 1 & 2)**
- **Halogen and Antimony Free. "Green" Device (Note 3)**
- **For automotive applications requiring specific change control (i.e. parts qualified to AEC-Q100/101/200, PPAP capable, and manufactured in IATF 16949 certified facilities), please [contact us](mailto:contact@diodes.com) or your local Diodes representative. <https://www.diodes.com/quality/product-definitions/>**

Mechanical Data

- Case: SOT89
- Case Material: Molded Plastic. "Green" Molding Compound. UL Flammability Rating 94V-0
- Moisture Sensitivity: Level 1 per J-STD-020
- Terminals: Finish - Matte Tin Plated Leads, Solderable per MIL-STD-202, Method 208 (G3)
- Weight: 0.05 grams (Approximate)

Application

- Emergency Lighting Circuits
- Motor Driving (Including DC Fans)
- Backlight Inverters
- Power Switches
- Gate Driving MOSFETs and IGBTs

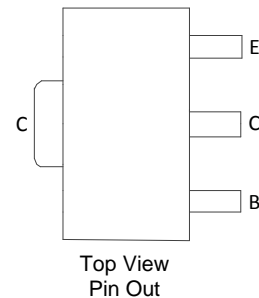
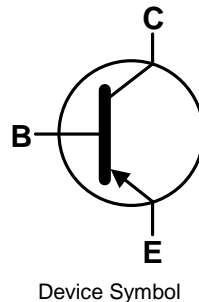

Ordering Information (Note 4)

Part Number	Compliance	Marking	Reel Size (inches)	Tape Width (mm)	Quantity Per Reel
ZXTP2013ZTA	AEC-Q101	953	7	12	1,000

- Notes:
1. EU Directive 2002/95/EC (RoHS), 2011/65/EU (RoHS 2) & 2015/863/EU (RoHS 3) compliant. All applicable RoHS exemptions applied.
 2. See <https://www.diodes.com/quality/lead-free/> for more information about Diodes Incorporated's definitions of Halogen- and Antimony-free, "Green" and Lead-free.
 3. Halogen- and Antimony-free "Green" products are defined as those which contain <900ppm bromine, <900ppm chlorine (<1500ppm total Br + Cl) and <1000ppm antimony compounds.
 4. For packaging details, go to our website at <https://www.diodes.com/design/support/packaging/diodes-packaging/>.

Marking Information

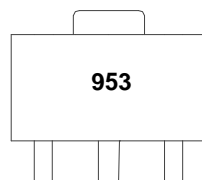

953 = Product Type Marking Code

Maximum Ratings (@T_A = +25°C, unless otherwise specified.)

Characteristic	Symbol	Value	Unit
Collector-Base Voltage	V _{CB0}	-140	V
Collector-Emitter Voltage	V _{CEO}	-100	V
Emitter-Base Voltage	V _{EB0}	-7	V
Continuous Collector Current	I _C	-3.5	A
Peak Pulse Current	I _{CM}	-10	A

Thermal Characteristics (@T_A = +25°C, unless otherwise specified.)

Characteristic	Symbol	Value	Unit
Power Dissipation (Note 5)	P _D	1.5	W
Linear Derating Factor		12	mW/°C
Power Dissipation (Note 6)	P _D	2.1	W
Linear Derating Factor		16.8	mW/°C
Thermal Resistance, Junction to Ambient (Note 5)	R _{θJA}	83	°C/W
Thermal Resistance, Junction to Ambient (Note 6)	R _{θJA}	60	°C/W
Operating and Storage Temperature Range	T _J , T _{STG}	-55 to +150	°C

- Notes:
5. For a device surface mounted on 25mm × 25mm × 1.6mm FR-4 PCB with high coverage of single sided 1oz copper, in still air conditions; device measured when operating in steady state condition.
 6. Same as note (5), except the device is mounted on 50mm × 50mm single sided 1oz weight copper.

Thermal Characteristics and Derating Information

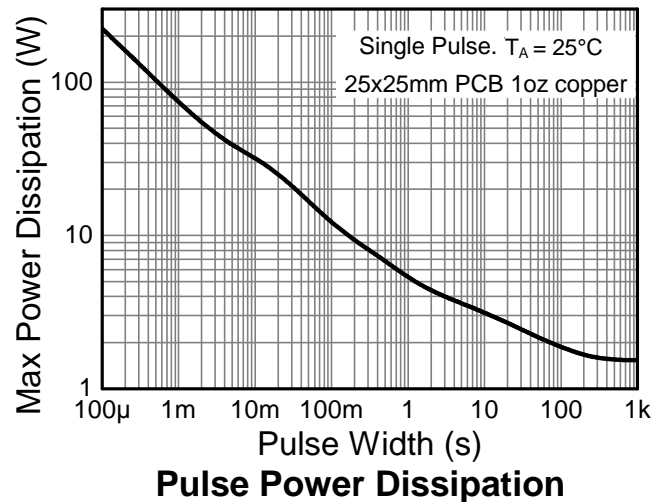
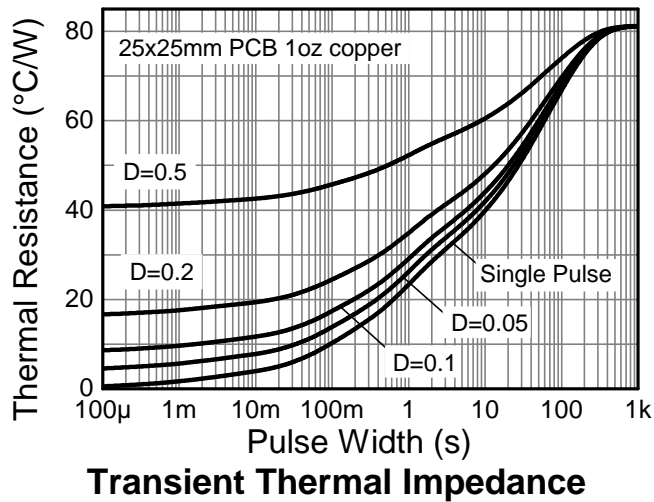
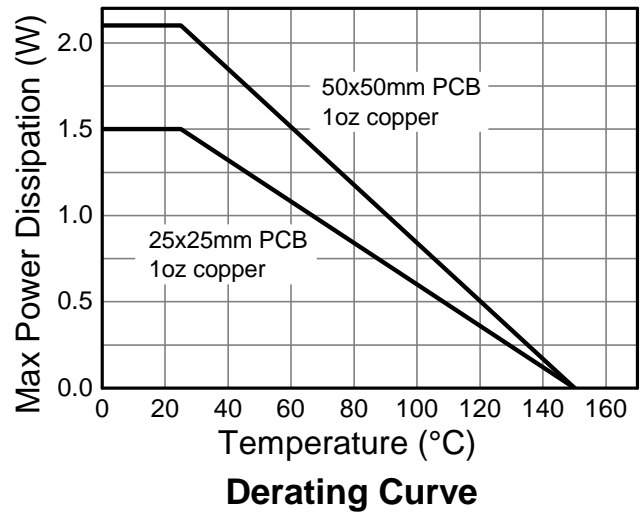
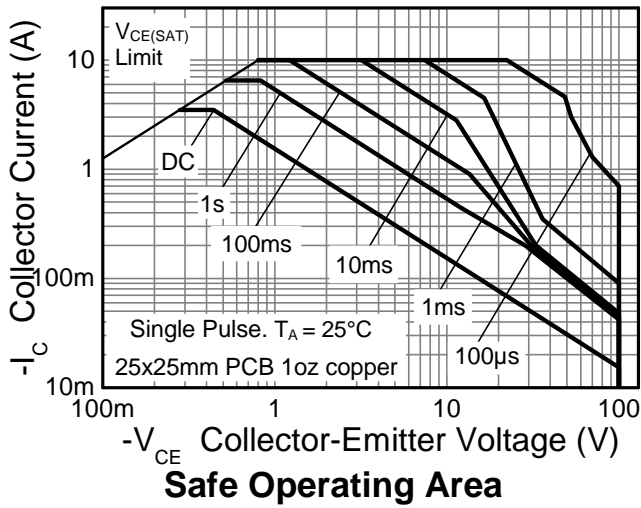

Electrical Characteristics (@T_A = +25°C, unless otherwise specified.)

Characteristic	Symbol	Min	Typ	Max	Unit	Test Condition
Collector-Base Breakdown Voltage	BV _{CB0}	-140	-160	—	V	I _C = -100μA
Collector-Emitter Breakdown Voltage (Note 7)	BV _{CER}	-140	-160	—	V	I _C = -1μA, R _B ≤ 1kΩ
Collector-Emitter Breakdown Voltage (Note 7)	BV _{CEO}	-100	-115	—	V	I _C = -10mA
Emitter-Base Breakdown Voltage	BV _{EBO}	-7	-8.1	—	V	I _E = -100μA
Collector Cutoff Current	I _{CB0}	—	< -1	-20 -500	nA nA	V _{CB} = -100V V _{CB} = -100V, T _A = +100°C
Collector Cutoff Current	I _{CER} R ≤ 1kΩ	—	< -1	-20 -500	nA nA	V _{CB} = -100V V _{CB} = -100V, T _A = +100°C
Emitter Cutoff Current	I _{EBO}	—	< -1	-10	nA	V _{EB} = -6V
DC Current Transfer Static Ratio (Note 7)	h _{FE}	100 100 25 15 —	250 200 50 30 5	— 300 — — —	—	I _C = -10mA, V _{CE} = -1V I _C = -1A, V _{CE} = -1V I _C = -3A, V _{CE} = -1V I _C = -4A, V _{CE} = -1V I _C = -10A, V _{CE} = -1V
Collector-Emitter Saturation Voltage (Note 7)	V _{CE(SAT)}	—	-20 -65 -110 -230	-30 -85 -135 -300	mV	I _C = -100mA, I _B = -10mA I _C = -1A, I _B = -100mA I _C = -2A, I _B = -200mA I _C = -4A, I _B = -400mA
Base-Emitter Saturation Voltage (Note 7)	V _{BE(SAT)}	—	-970	-1060	mV	I _C = -4A, I _B = -400mA
Base-Emitter Turn-On Voltage (Note 7)	V _{BE(ON)}	—	-910	-1030	mV	I _C = -4A, V _{CE} = -1V
Transitional Frequency	f _T	—	125	—	MHz	I _C = -100mA, V _{CE} = -10V, f = 50MHz
Output Capacitance (Note 7)	C _{OB0}	—	42	—	pF	V _{CB} = -10V, f = 1MHz
Switching Time	t _{ON}	—	42	—	ns	V _{CC} = -10V, I _C = -1A, I _{B1} = -I _{B2} = -100mA
	t _{OFF}	—	540	—		

Note: 7. Measured under pulsed conditions. Pulse width ≤ 300μs. Duty cycle ≤ 2%.

Typical Electrical Characteristics (@T_A = +25°C, unless otherwise specified.)

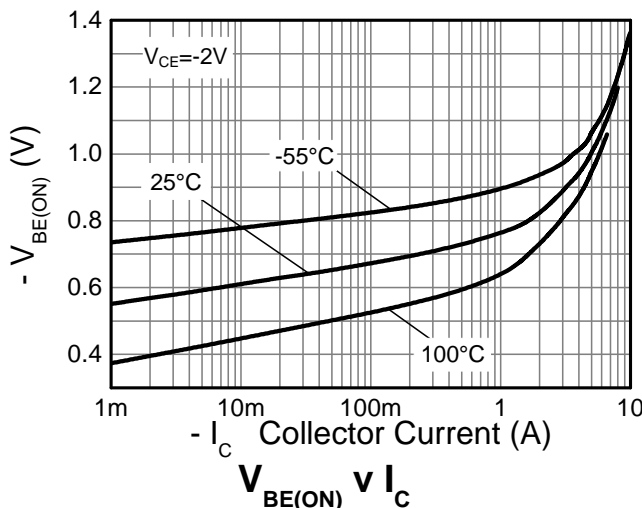
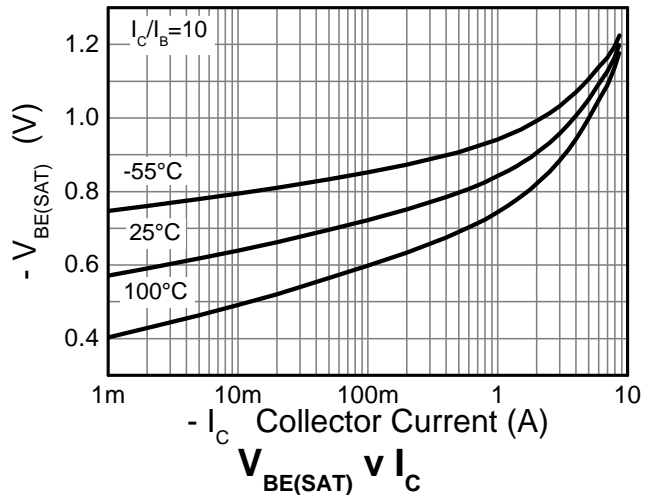
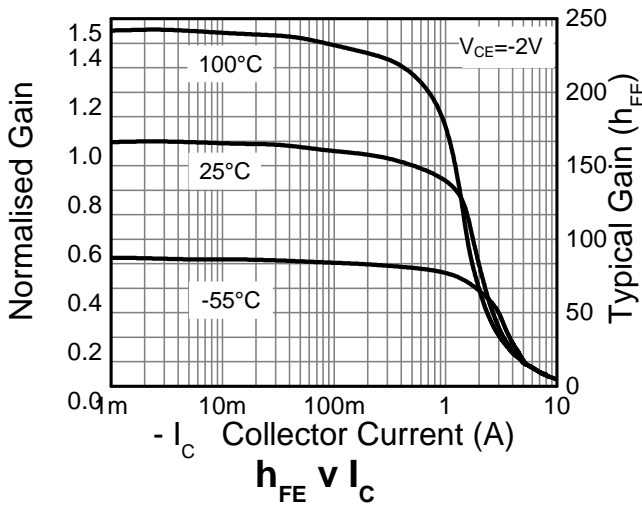
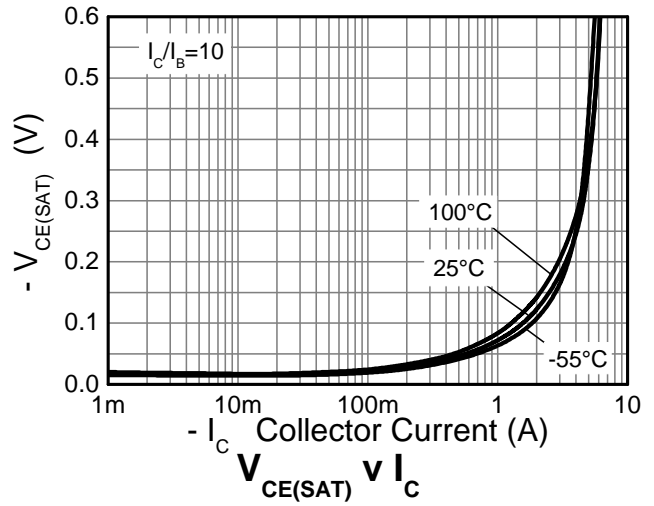
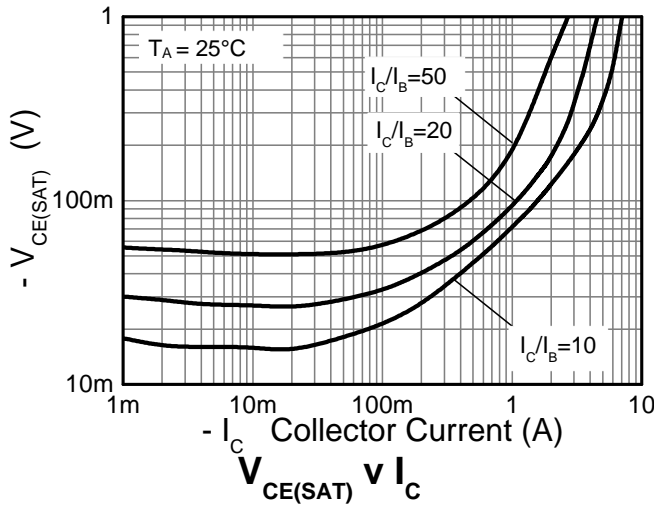

Package Outline Dimensions

Please see <http://www.diodes.com/package-outlines.html> for the latest version.

SOT89

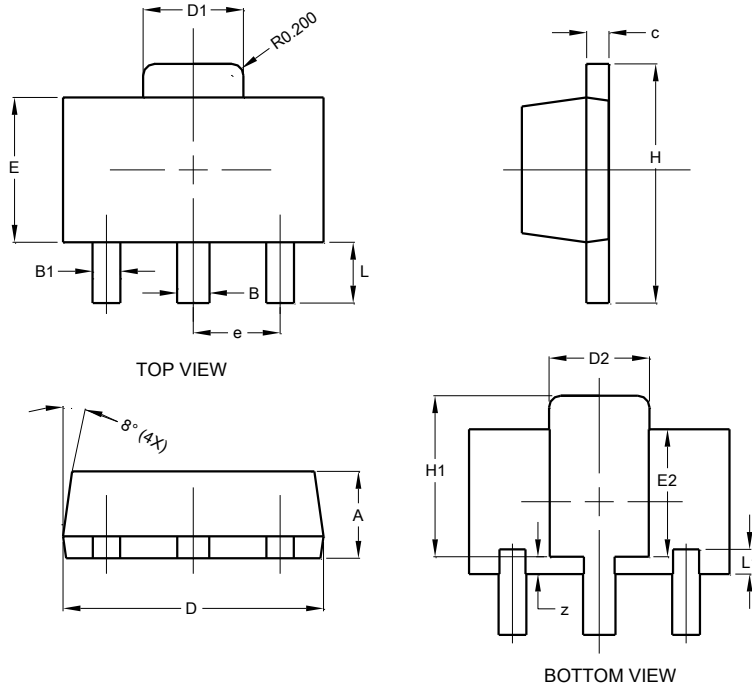

SOT89			
Dim	Min	Max	Typ
A	1.40	1.60	1.50
B	0.50	0.62	0.56
B1	0.42	0.54	0.48
c	0.35	0.43	0.38
D	4.40	4.60	4.50
D1	1.62	1.83	1.733
D2	1.61	1.81	1.71
E	2.40	2.60	2.50
E2	2.05	2.35	2.20
e	-	-	1.50
H	3.95	4.25	4.10
H1	2.63	2.93	2.78
L	0.90	1.20	1.05
L1	0.327	0.527	0.427
z	0.20	0.40	0.30
All Dimensions in mm			

Suggested Pad Layout

Please see <http://www.diodes.com/package-outlines.html> for the latest version.

SOT89

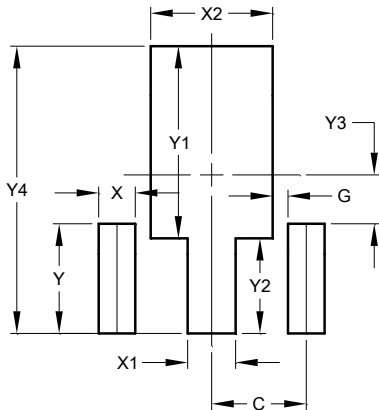

Dimensions	Value (in mm)
C	1.500
G	0.244
X	0.580
X1	0.760
X2	1.933
Y	1.730
Y1	3.030
Y2	1.500
Y3	0.770
Y4	4.530

IMPORTANT NOTICE

DIODES INCORPORATED MAKES NO WARRANTY OF ANY KIND, EXPRESS OR IMPLIED, WITH REGARDS TO THIS DOCUMENT, INCLUDING, BUT NOT LIMITED TO, THE IMPLIED WARRANTIES OF MERCHANTABILITY AND FITNESS FOR A PARTICULAR PURPOSE (AND THEIR EQUIVALENTS UNDER THE LAWS OF ANY JURISDICTION).

Diodes Incorporated and its subsidiaries reserve the right to make modifications, enhancements, improvements, corrections or other changes without further notice to this document and any product described herein. Diodes Incorporated does not assume any liability arising out of the application or use of this document or any product described herein; neither does Diodes Incorporated convey any license under its patent or trademark rights, nor the rights of others. Any Customer or user of this document or products described herein in such applications shall assume all risks of such use and will agree to hold Diodes Incorporated and all the companies whose products are represented on Diodes Incorporated website, harmless against all damages.

Diodes Incorporated does not warrant or accept any liability whatsoever in respect of any products purchased through unauthorized sales channel. Should Customers purchase or use Diodes Incorporated products for any unintended or unauthorized application, Customers shall indemnify and hold Diodes Incorporated and its representatives harmless against all claims, damages, expenses, and attorney fees arising out of, directly or indirectly, any claim of personal injury or death associated with such unintended or unauthorized application.

Products described herein may be covered by one or more United States, international or foreign patents pending. Product names and markings noted herein may also be covered by one or more United States, international or foreign trademarks.

This document is written in English but may be translated into multiple languages for reference. Only the English version of this document is the final and determinative format released by Diodes Incorporated.

LIFE SUPPORT

Diodes Incorporated products are specifically not authorized for use as critical components in life support devices or systems without the express written approval of the Chief Executive Officer of Diodes Incorporated. As used herein:

A. Life support devices or systems are devices or systems which:

1. are intended to implant into the body, or
2. support or sustain life and whose failure to perform when properly used in accordance with instructions for use provided in the labeling can be reasonably expected to result in significant injury to the user.

B. A critical component is any component in a life support device or system whose failure to perform can be reasonably expected to cause the failure of the life support device or to affect its safety or effectiveness.

Customers represent that they have all necessary expertise in the safety and regulatory ramifications of their life support devices or systems, and acknowledge and agree that they are solely responsible for all legal, regulatory and safety-related requirements concerning their products and any use of Diodes Incorporated products in such safety-critical, life support devices or systems, notwithstanding any devices- or systems-related information or support that may be provided by Diodes Incorporated. Further, Customers must fully indemnify Diodes Incorporated and its representatives against any damages arising out of the use of Diodes Incorporated products in such safety-critical, life support devices or systems.

Copyright © 2020, Diodes Incorporated

www.diodes.com