

BBM Programmer DATASHEET

Document Revision: 1.0
Document Date: 28/07/2021

Content subject to change at any time, please refer to
www.breadboardmates.com for the latest revision.

Table of Contents

Document Revision History	3
Hardware Revision History	3
About Breadboard Mates	4
Product Description	5
Product Features	5
Hardware Detail	5
Programming Hardware	6
Programming Hardware - Overview	6
Programming Hardware – Detail	6
Hardware Interfaces	7
5-Pin System Pins	7
Software	7
Typical Connections	8
Breadboard Interface with Programmer	8
Hardware Drawing	9
Hardware Schematic	10
Legal Notice	11

Document Revision History

Revision Number	Date	Description
0.1	07/07/2021	Initial Draft
0.2	19/07/2021	Formatting Update
1.0	28/07/2021	Initial Public Release

Hardware Revision History

Revision Number	Date	Description
1.0	15/01/2021	Initial Revision

About Breadboard Mates

Breadboard Mates (aka BBM) is an Australian start-up company and was established in 2020 with the aim to bring breadboard friendly display products to the market, cutting down the time and components required to develop or experiment with electronics.

Hobbyist to Professional, BBM products can be utilised for development or education or anything in between. Development of projects / applications is made incredibly easy with the help of the revolutionary Mates Studio IDE.

The Mates Studio IDE is unlike any other, it offers 4 different programming methods with interchangeable pages and widgets, and helps speed up development for stand alone, host driven or PC tethered applications.

Breadboard Mates is constantly working on new product ideas, so keep a watch on the breadboardmates.com website for new product releases.

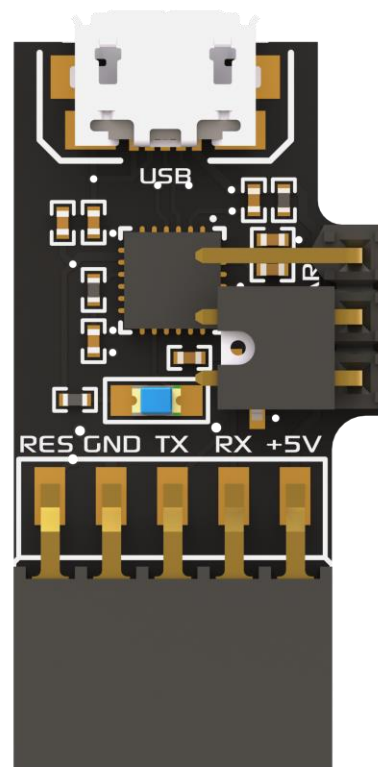

Product Description

BBM-PROG (ref. BBM Programmer) is a simple USB programmer for BBM products, providing a simple 5-way programming interface, and selection option for programming other devices such as 'barebones' Arduino (Atmel) processors.

Product Features

The BBM Programmer offers a simple connection for a MatesBUS compatible device, such as the TIMI-96, connecting to one side (5-pins) of the MatesBUS interface, allowing easy programming of the BBM device using the Mates Studio IDE.

Hardware Detail

The BBM Programmer has a microUSB Interface, for connecting the programmer to your PC, using a standard microUSB cable. The BBM Programmer then utilises a standard 5-pin interface for programming the 4D Labs processors found on BBM products, such as the TIMI-96. This 5-pin interface is one side of the MatesBUS Interface.

The BBM-Programmer does not come with the microUSB cable, this can be purchased from virtually any hardware/computer store.

The MatesBUS Interface is made up of 2 rows of 5 pins, 0.1" (2.54mm) pitch, spaced 0.3" (7.62mm) apart, ideal for direct plug into a breadboard, or compatible adaptor or development board.

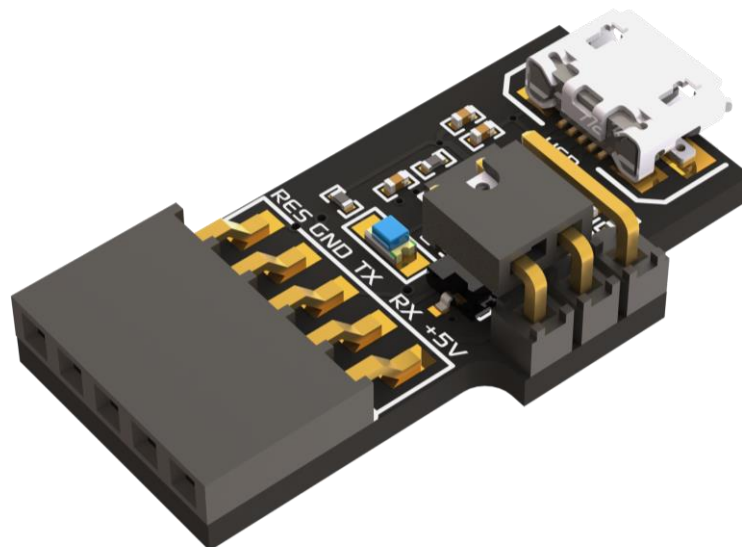

Programming Hardware

Programming Hardware - Overview

The BBM Programmer is a USB to Serial programmer for application and firmware updates, which programs both the Processor Flash memory, along with the on-board SPI Flash memory of BBM products, such as the TIMI-96.

The Programmer, dubbed BBM-Prog, is the official BBM Programmer and can also be used for testing and debugging of TIMI applications using the Mates Studio IDE.

Programming Hardware – Detail

The BBM-PROG utilises the Silicon Labs CP2104 USB to UART bridge, and uses the TIMI's Serial UART to load applications, firmware/PmmC and media content.

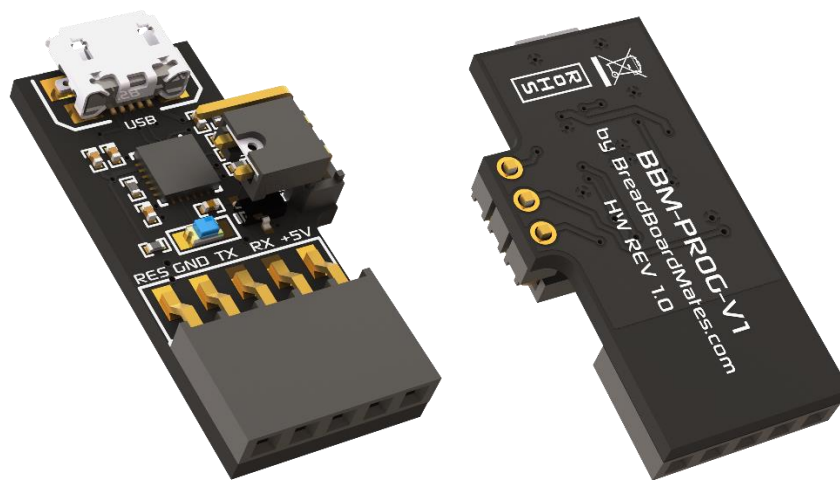

The BBM-PROG features a 3-pin jumper with shunt, which is present to change the way the programmer handles the Reset line, utilised by TIMI and other devices.

TIMI requires the jumper to be positioned like the image above, closest to the 5-way female header. This makes the programmer compatible with programming the 4D Labs Pixxi-28 processor.

If the jumper is placed on the 2 pins closest to the USB connector, this will make the programmer compatible with programming Atmel chips, such as is used on many of the Arduino boards, or barebone chips. This may also be compatible with other microcontrollers too.

Hardware Interfaces

The BBM Programmer has a microUSB Interface, for connecting the programmer to your PC, using a standard microUSB cable. It then has a 5-way interface for connecting to a compatible BBM device that is to be programmed. The 5-way interface is one half of the standard MatesBUS interface, found on many BBM products.

5-Pin System Pins

+5V (Device Supply Voltage)

MatesBUS supply voltage pin. This pin supplies the MatesBUS device with 5VDC from this BBM Programmer.

GND (Module Ground)

Device ground pin.

TX (Serial UART Transmit)

TX of the BBM Programmer connects to RX of the BBM device, this is the 3.3V Asynchronous Serial UART Transmit for communications between the device connected and the BBM Programmer.

RX (Serial UART Receive)

RX of the BBM Programmer connects to TX of the BBM device, this is the 3.3V Asynchronous Serial UART Receive for communications between the device connected and the BBM Programmer.

RESET (MatesBUS Reset)

This pin is to allow the BBM Programmer to reset the processor on the BBM Device, which is a requirement in the programming sequence.

Software

The BBM Programmer features a Silicon Labs USB to Serial converter, and the driver required for this can be found directly from the Silicon Labs website.

For best results, select the latest 'Universal' Windows Driver available from the Silicon Labs Website:

<https://www.silabs.com/developers/usb-to-uart-bridge-vcp-drivers>

At the time of writing this, here is the direct link for the latest driver:

https://www.silabs.com/documents/public/software/CP210x_Universal_Windows_Driver.zip

Typical Connections

Breadboard Interface with Programmer

One of the simplest interfaces for programming devices such as TIMI-96, is connecting TIMI-96 to the bottom of a breadboard, connecting the 5-way right angle header into the breadboard next to the H2 header side of TIMI-96, and attaching the BBM Programmer to the 5-way header.

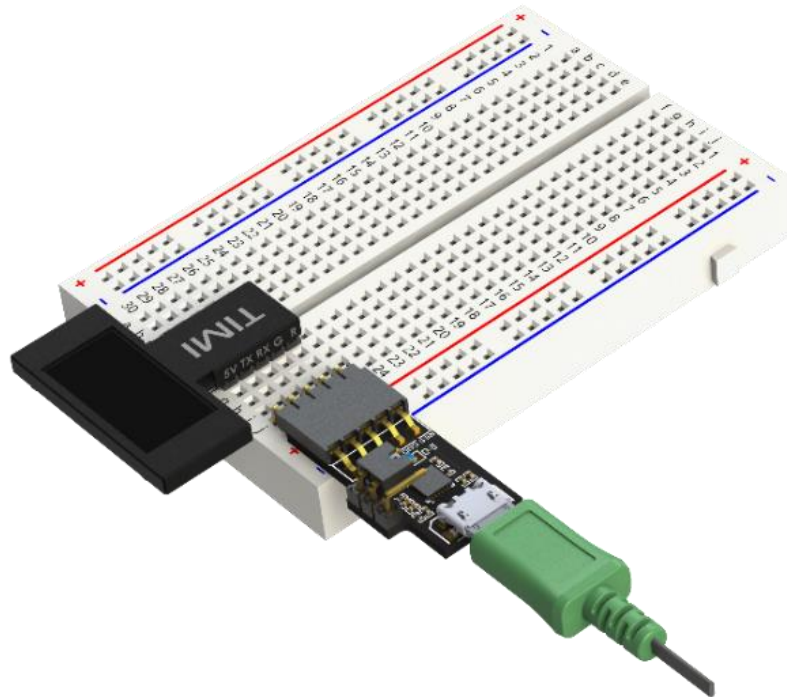

The BBM Programmer can also be directly connected to the appropriate row of 5 male pins on BBM products such as TIMI-96 if direct programming is desired instead.

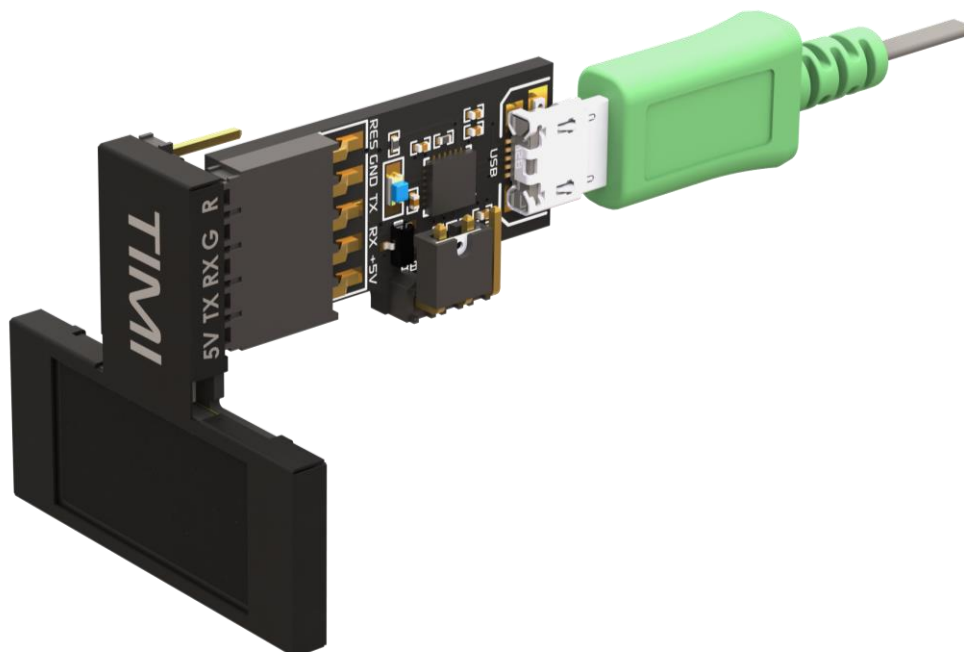

Hardware Drawing

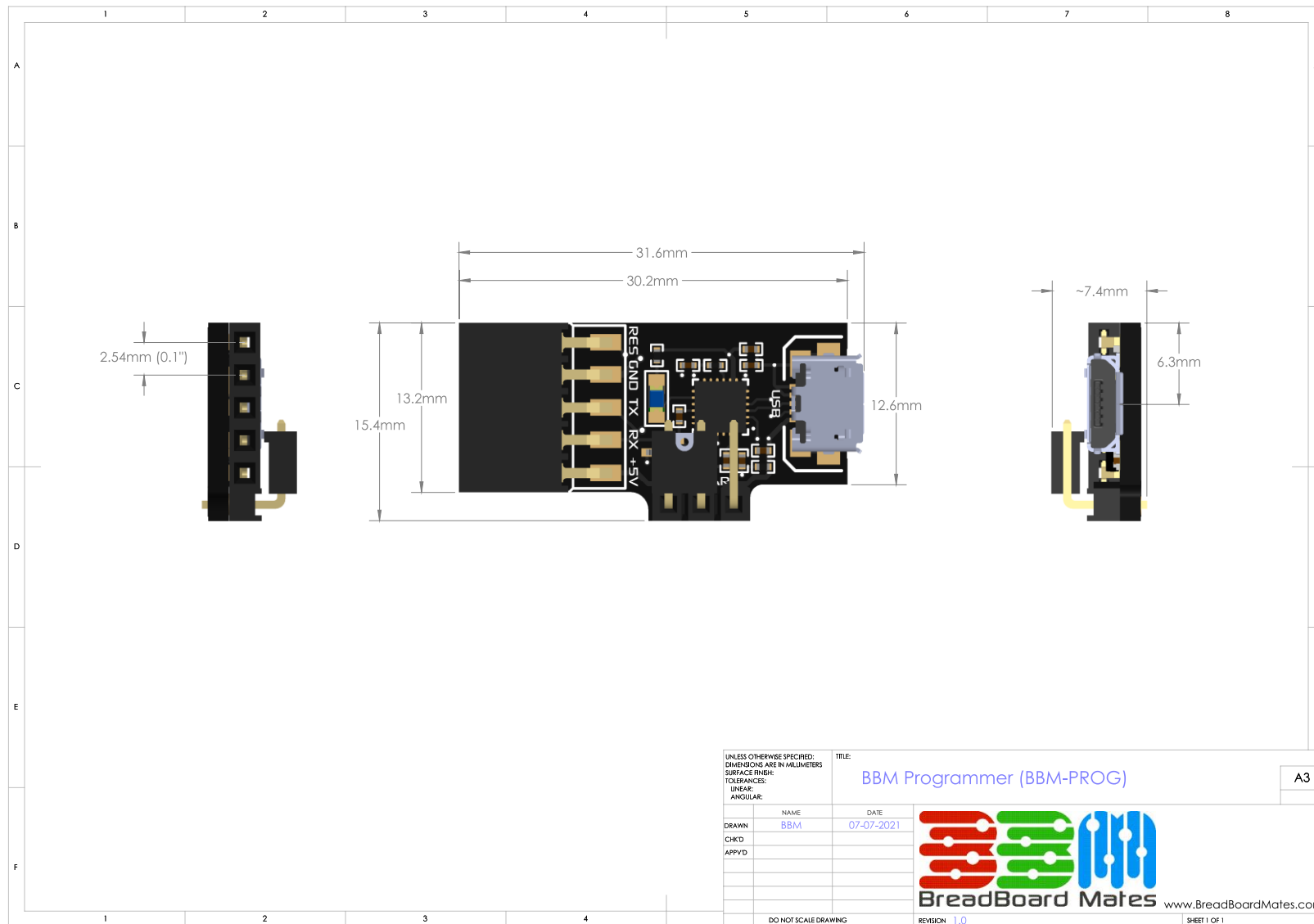

Hardware Schematic

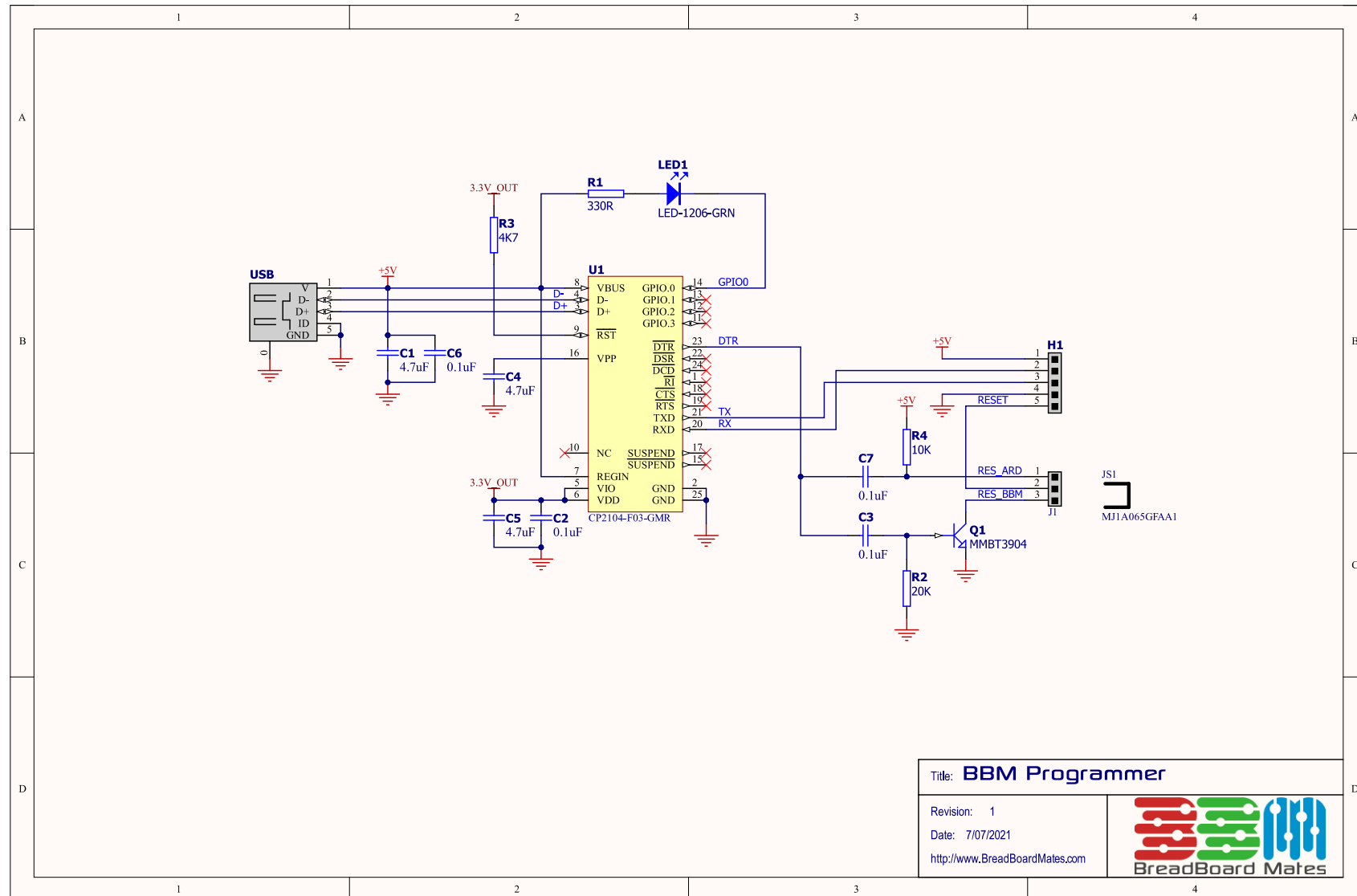

Legal Notice

Proprietary Information

The information contained in this document is the property of 'Breadboard Mates' and may be the subject of patents pending or granted and must not be copied or disclosed without prior written permission.

Breadboard Mates endeavours to ensure that the information in this document is correct and fairly stated but does not accept liability for any error or omission. The development of Breadboard Mates products and services are continuous and published information may not be up to date. It is important to check the current position with Breadboard Mates. Breadboard Mates reserves the right to modify, update or makes changes to Specifications or written material without prior notice at any time.

All trademarks belong to their respective owners and are recognised and acknowledged.

Disclaimer of Warranties & Limitation of Liability

Breadboard Mates makes no warranty, either expressed or implied with respect to any product, and specifically disclaims all other warranties, including, without limitation, warranties for merchantability, non-infringement, and fitness for any particular purpose.

Information contained in this publication regarding device applications and the like is provided only for your convenience and may be superseded by updates. It is your responsibility to ensure that your application meets with your specifications.

Images and graphics used throughout this document are for illustrative purposes only. All images and graphics used are possible to be displayed on the Breadboard Mates range of products, however the quality may vary.

In no event shall Breadboard Mates be liable to the buyer or to any third party for any indirect, incidental, special, consequential, punitive, or exemplary damages (including without limitation lost profits, lost savings, or loss of business opportunity) arising out of or relating to any product or service provided or to be provided by Breadboard Mates, or the use or inability to use the same, even if Breadboard Mates has been advised of the possibility of such damages.

Breadboard Mates products are not fault tolerant nor designed, manufactured or intended for use or resale as on line control equipment in hazardous environments requiring fail – safe performance, such as in the operation of nuclear facilities, aircraft navigation or communication systems, air traffic control, direct life support machines or weapons systems in which the failure of the product could lead directly to death, personal injury or severe physical or environmental damage ('High Risk Activities'). Breadboard Mates and its suppliers specifically disclaim any expressed or implied warranty of fitness for High-Risk Activities.

Use of Breadboard Mates products and devices in 'High Risk Activities' and in any other application is entirely at the buyer's risk, and the buyer agrees to defend, indemnify, and hold harmless Breadboard Mates from any-and-all damages, claims, suits, or expenses resulting from such use. No licenses are conveyed, implicitly or otherwise, under any Breadboard Mates intellectual property rights.