

# Standard Power MOSFET

IXTH / IXTM 5N100  
IXTH / IXTM 5N100A

$V_{DSS}$	$I_{D25}$	$R_{DS(on)}$
1000 V	5 A	2.4 $\Omega$
1000 V	5 A	2.0 $\Omega$

## N-Channel Enhancement Mode



Symbol	Test Conditions	Maximum Ratings	
$V_{DSS}$	$T_J = 25^\circ\text{C}$ to $150^\circ\text{C}$	1000	V
$V_{DGR}$	$T_J = 25^\circ\text{C}$ to $150^\circ\text{C}$ ; $R_{GS} = 1\text{ M}\Omega$	1000	V
$V_{GS}$	Continuous	$\pm 20$	V
$V_{GSM}$	Transient	$\pm 30$	V
$I_{D25}$	$T_C = 25^\circ\text{C}$	5	A
$I_{DM}$	$T_C = 25^\circ\text{C}$ , pulse width limited by $T_{JM}$	20	A
$P_D$	$T_C = 25^\circ\text{C}$	180	W
$T_J$		-55 ... +150	$^\circ\text{C}$
$T_{JM}$		150	$^\circ\text{C}$
$T_{stg}$		-55 ... +150	$^\circ\text{C}$
$M_d$	Mounting torque	1.13/10	Nm/lb.in.
<b>Weight</b>		TO-204 = 18 g, TO-247 = 6 g	
	Maximum lead temperature for soldering 1.6 mm (0.062 in.) from case for 10 s	300	$^\circ\text{C}$

TO-247 AD (IXTH)

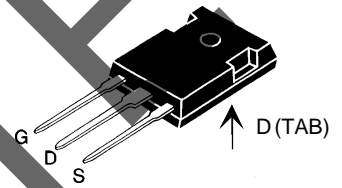

TO-204 AA (IXTM)

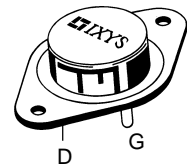

G = Gate, D = Drain,  
S = Source, TAB = Drain

### Features

- International standard packages
- Low  $R_{DS(on)}$  HDMOS™ process
- Rugged polysilicon gate cell structure
- Low package inductance (< 5 nH)
  - easy to drive and to protect
- Fast switching times

### Applications

- Switch-mode and resonant-mode power supplies
- Motor controls
- Uninterruptible Power Supplies (UPS)
- DC choppers

### Advantages

- Easy to mount with 1 screw (TO-247) (isolated mounting screw hole)
- Space savings
- High power density

Symbol	Test Conditions	Characteristic Values ( $T_J = 25^\circ\text{C}$ , unless otherwise specified)		
		min.	typ.	max.
$V_{DSS}$	$V_{GS} = 0\text{ V}$ , $I_D = 3\text{ mA}$	1000		V
$V_{GS(th)}$	$V_{DS} = V_{GS}$ , $I_D = 250\ \mu\text{A}$	2		4.5 V
$I_{GSS}$	$V_{GS} = \pm 20\text{ V}_{DC}$ , $V_{DS} = 0$			$\pm 100\text{ nA}$
$I_{DSS}$	$V_{DS} = 0.8 \cdot V_{DSS}$ , $V_{GS} = 0\text{ V}$			250 $\mu\text{A}$ 1 mA
$R_{DS(on)}$	$V_{GS} = 10\text{ V}$ , $I_D = 0.5 I_{D25}$			2.4 $\Omega$ 2.0 $\Omega$
	Pulse test, $t \leq 300\ \mu\text{s}$ , duty cycle $d \leq 2\%$			

Symbol	Test Conditions	Characteristic Values ( $T_J = 25^\circ\text{C}$ , unless otherwise specified)			
		min.	typ.	max.	
$g_{fs}$	$V_{DS} = 10\text{ V}; I_D = 0.5 \cdot I_{D25}$ , pulse test	4	6	S	
$C_{iss}$	$V_{GS} = 0\text{ V}, V_{DS} = 25\text{ V}, f = 1\text{ MHz}$		2600	pF	
$C_{oss}$			180	pF	
$C_{rss}$			45	pF	
$t_{d(on)}$	$V_{GS} = 10\text{ V}, V_{DS} = 0.5 \cdot V_{DSS}, I_D = 0.5 I_{D25}$ $R_G = 4.7\ \Omega$ , (External)		35	100	ns
$t_r$			20	50	ns
$t_{d(off)}$			100	200	ns
$t_f$			30	80	ns
$Q_{g(on)}$	$V_{GS} = 10\text{ V}, V_{DS} = 0.5 \cdot V_{DSS}, I_D = 0.5 I_{D25}$		88	130	nC
$Q_{gs}$			21	30	nC
$Q_{gd}$			38	70	nC
$R_{thJC}$			0.7	K/W	
$R_{thCK}$		0.25		K/W	

### Source-Drain Diode

Symbol	Test Conditions	Characteristic Values ( $T_J = 25^\circ\text{C}$ , unless otherwise specified)			
		min.	typ.	max.	
$I_S$	$V_{GS} = 0\text{ V}$			5	A
$I_{SM}$	Repetitive; pulse width limited by $T_{JM}$			20	A
$V_{SD}$	$I_F = I_S, V_{GS} = 0\text{ V}$ , Pulse test, $t \leq 300\ \mu\text{s}$ , duty cycle $d \leq 2\%$			1.5	V
$t_{rr}$	$I_F = I_S, -di/dt = 100\text{ A}/\mu\text{s}, V_R = 100\text{ V}$		900		ns

### TO-247 AD (IXTH) Outline

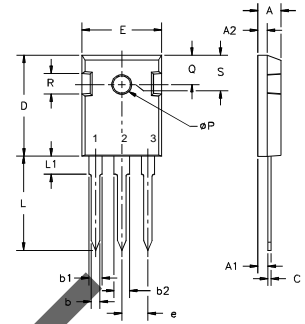

Terminals: 1 - Gate 2 - Drain  
3 - Source Tab - Drain

Dim.	Millimeter		Inches	
	Min.	Max.	Min.	Max.
A	4.7	5.3	.185	.209
A <sub>1</sub>	2.2	2.54	.087	.102
A <sub>2</sub>	2.2	2.6	.059	.098
b	1.0	1.4	.040	.055
b <sub>1</sub>	1.65	2.13	.065	.084
b <sub>2</sub>	2.87	3.12	.113	.123
C	.4	.8	.016	.031
D	20.80	21.46	.819	.845
E	15.75	16.26	.610	.640
e	5.20	5.72	0.205	0.225
L	19.81	20.32	.780	.800
L1		4.50		.177
ØP	3.55	3.65	.140	.144
Q	5.89	6.40	0.232	0.252
R	4.32	5.49	.170	.216
S	6.15	BSC	242	BSC

### TO-204AA (IXTM) Outline

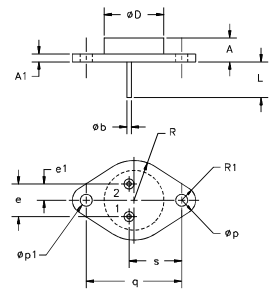

Pins 1 - Gate 2 - Source  
Case - Drain

Dim.	Millimeter		Inches	
	Min.	Max.	Min.	Max.
A	6.4	11.4	.250	.450
A <sub>1</sub>		3.42		.135
Øb	.97	1.09	.038	.043
ØD		22.22		.875
e	10.67	11.17	.420	.440
e <sub>1</sub>	5.21	5.71	.205	.225
L	7.93		.312	
Øp	3.84	4.19	.151	.165
Øp <sub>1</sub>	3.84	4.19	.151	.165
q	30.15	BSC	1.187	BSC
R		13.33		.525
R <sub>1</sub>		4.77		.188
s	16.64	17.14	.655	.675

Fig. 1 Output Characteristics

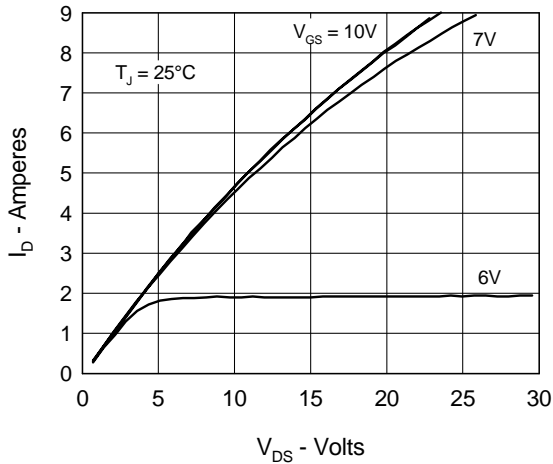

Fig. 2 Input Admittance

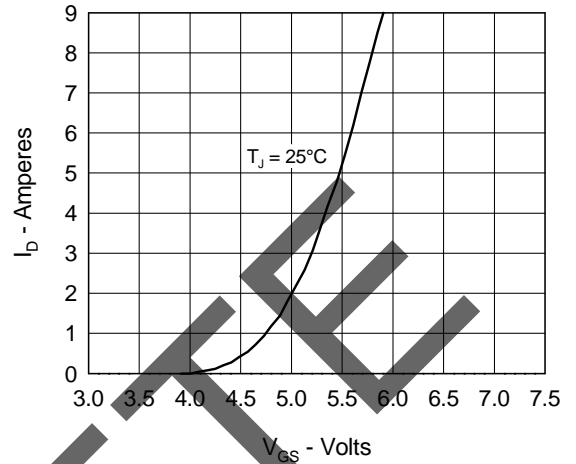

Fig. 3  $R_{DS(on)}$  vs. Drain Current

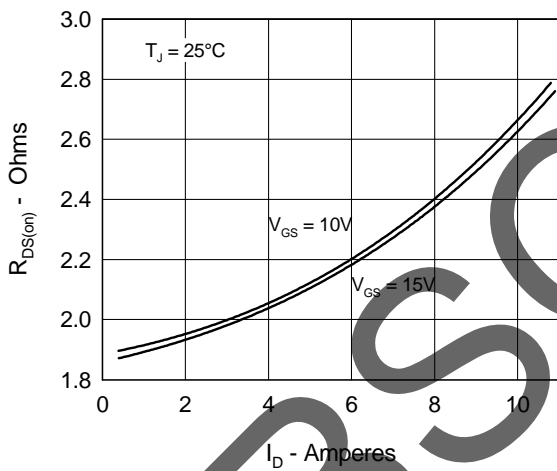

Fig. 4 Temperature Dependence of Drain to Source Resistance

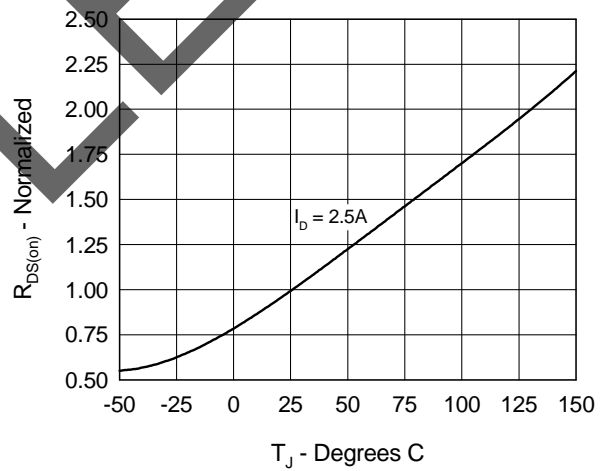

Fig. 5 Drain Current vs. Case Temperature

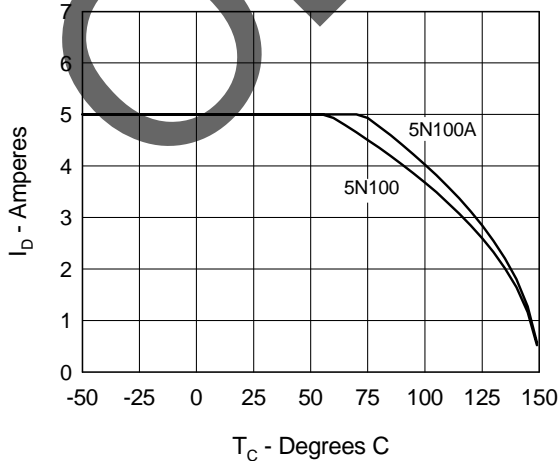
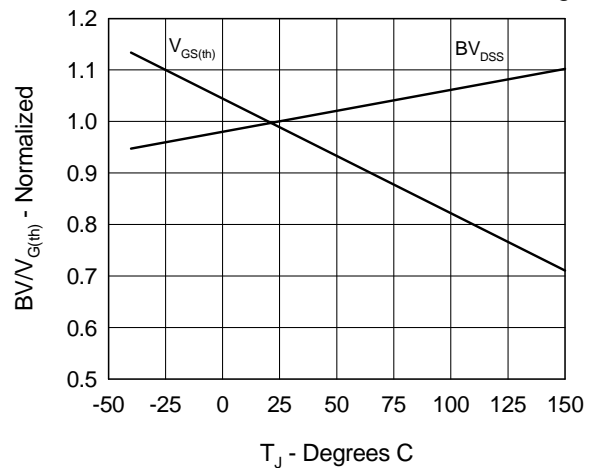
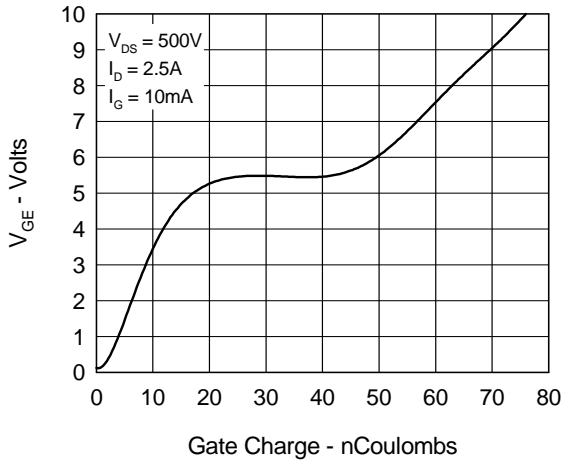

Fig. 6 Temperature Dependence of Breakdown and Threshold Voltage



**Fig.7 Gate Charge Characteristic Curve**



**Fig.8 Forward Bias Safe Operating Area**

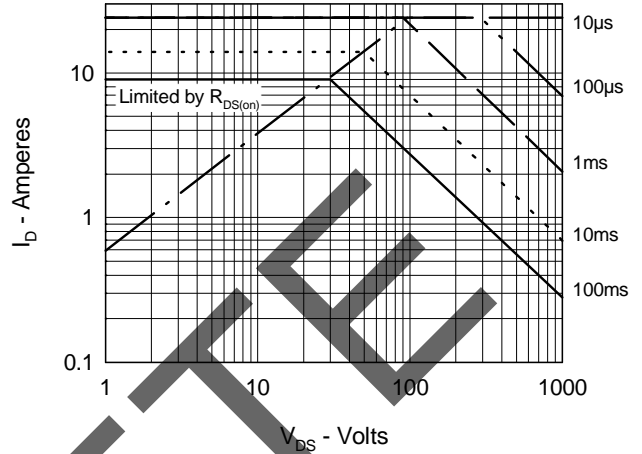

**Fig.9 Capacitance Curves**

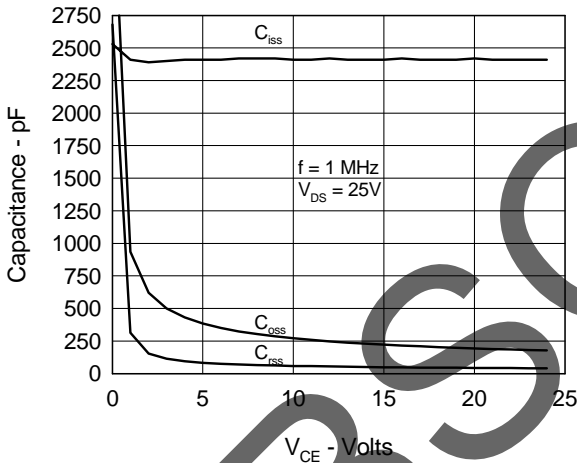

**Fig.10 Source Current vs. Source to Drain Voltage**

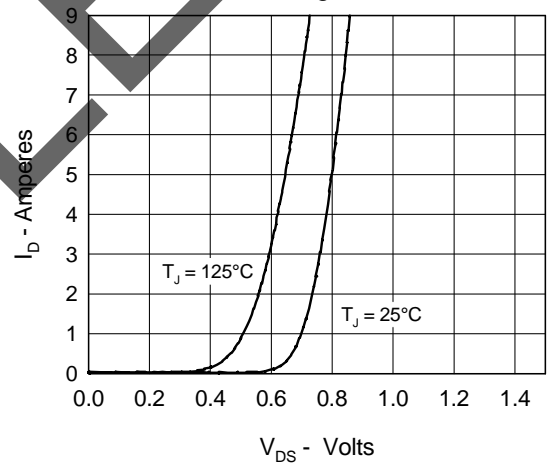

**Fig.11 Transient Thermal Impedance**

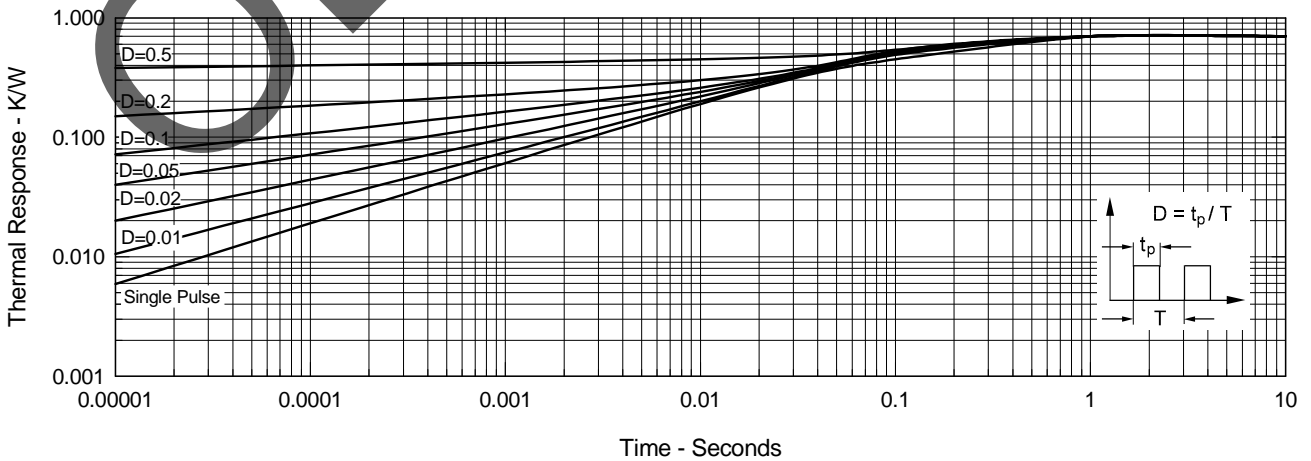



---

Disclaimer Notice - Information furnished is believed to be accurate and reliable. However, users should independently evaluate the suitability of and test each product selected for their own applications. Littelfuse products are not designed for, and may not be used in, all applications. Read complete Disclaimer Notice at [www.littelfuse.com/disclaimer-electronics](http://www.littelfuse.com/disclaimer-electronics).