

E3Z-LS



Distance-settable Sensor Unaffected by Workpiece Color and Background

- Distance-settable triangulation model unaffected by color.
- Simple positioning settings using a clear LED spot. (E3Z-LS□3/LS□8)
- Detect minute steps.



Be sure to read *Safety Precautions* on page 8.

For the most recent information on models that have been certified for safety standards, refer to your OMRON website.

Ordering Information

Sensors (Refer to *Dimensions* on page 10.)

Red light

Sensing method	Appearance	Connection method	Sensing distance (white paper)	Model		
				NPN output	PNP output	
Distance-settable		Pre-wired (2 m)	<p>20 mm 40 mm 200 mm BGS (at min. setting) BGS (at max. setting) FGS (at min. setting) FGS (at max. setting) Incident light level threshold (fixed)</p>	E3Z-LS61 2M *1	E3Z-LS81 2M *1	
		Connector (M8, 4 pins)		E3Z-LS66	E3Z-LS86	
		Pre-wired (2 m)		<p>2 mm 20 mm 80 mm BGS (at min. setting) BGS (at max. setting)</p>	E3Z-LS63 2M	E3Z-LS83 2M *2
		Connector (M8, 4 pins)			E3Z-LS68	E3Z-LS88

*1. M12 Standard Pre-wired Connector Models are also available. When ordering, add "-M1J 0.3M" to the end of the model number (e.g., E3Z-LS61-M1J 0.3M). The cable is 0.3 m long.

*2. M12 Pre-wired Smartclick Connector Models are also available. When ordering, add "-M1TJ 0.3M" to the end of the model number (e.g., E3Z-LS83-M1TJ 0.3M). The cable is 0.3 m long.

Accessories (Order Separately)

Mounting Brackets

Sensor I/O Connectors (Sockets on One Cable End)

(Models for Connectors: A Connector is not provided with the Sensor. Be sure to order a Connector separately.) (Refer to *Dimensions* on XS3)

Cable specification	Appearance	Type of cable	Model
Standard M8 cable	Straight *1	2 m	XS3F-M421-402-A
		5 m	XS3F-M421-405-A
	L-shaped *1 *2	2 m	XS3F-M422-402-A
		5 m	XS3F-M422-405-A

*1. The connector will not rotate after connecting.

*2. The cable is fixed at an angle of 180° from the sensor emitter/receiver surface.

Ratings and Specifications

Sensing method		Distance-settable			
Model	NPN output	E3Z-LS61	E3Z-LS66	E3Z-LS63	E3Z-LS68
Item	PNP output	E3Z-LS81	E3Z-LS86	E3Z-LS83	E3Z-LS88
Sensing distance	BGS	White or black paper (100 × 100 mm): 20 mm to set distance		2 mm to set distance (80 mm max.)	
	FGS	White paper (100 × 100 mm): Set distance to 200 mm min. Black paper (100 × 100 mm): Set distance to 160 mm min.		-----	
Setting range		White paper (100 × 100 mm): 40 to 200 mm Black paper (100 × 100 mm): 40 to 160 mm		White paper (25 × 25 mm): 20 to 80 mm	
Differential travel		10% of set distance max. (Refer to <i>Differential Travel vs. Sensing Distance</i> on page 4.)		2% of set distance max.	
Reflectivity characteristic (black/white error)		10% of set distance max.		5% of set distance max.	
Light source (wavelength)		Red LED (670 nm)		Red LED (650 nm)	
Power supply voltage		12 to 24 VDC ±10%, ripple (p-p): 10% max.			
Current consumption		30 mA max.			
Control output		Load power supply voltage: 26.4 VDC max., Load current: 100 mA max. (residual voltage 1 V max.), Open collector output (NPN or PNP depending on model) Light-ON/Dark-ON switch selectable			
BGS/FGS selection		BGS: Open or connected to GND FGS: Connected to Vcc		BGS: Open or connected to GND	
Protection circuits		Reversed power supply polarity protection, Output short-circuit protection, Mutual interference prevention			
Response time		Operate or reset: 1 ms max.			
Distance setting		5-turn endless adjuster			
Ambient illumination (Receiver side)		Incandescent lamp: 3,000 lx max.; Sunlight: 10,000 lx max.			
Ambient temperature range		Operating: -25 to 55°C, Storage: -40 to 70°C (with no icing or condensation)			
Ambient humidity range		Operating: 35% to 85%, Storage: 35% to 95% (with no condensation)			
Insulation resistance		20 MΩ min. at 500 VDC			
Dielectric strength		1,000 VAC at 50/60 Hz for 1 minute			
Vibration resistance		Destruction: 10 to 55 Hz, 1.5-mm double amplitude for 2 hours each in X, Y, and Z directions			
Shock resistance		Destruction: 500 m/s ² for 3 times each in X, Y, and Z directions			
Degree of protection		IP67 (IEC 60529)			
Connection method		Pre-wired (standard lengths: 2 m and 0.5 m)	Connector (M8, 4 pins)	Pre-wired (standard lengths: 2 m and 0.5 m)	Connector (M8, 4 pins)
Indicators		Operation indicator (orange), Stability indicator (green)			
Weight (packed state)		Pre-wired Sensors, 2 m: Approx. 65 g	Approx. 20 g	Pre-wired Sensors, 2 m: Approx. 65 g	Approx. 20 g
Material	Case	PBT (polybutylene terephthalate)			
	Lens	Modified polyarylate resin			
Accessories		Instruction manual (Mounting Brackets must be ordered separately.)			

Engineering Data (Reference Value)

Operating Range

E3Z-LS□1/LS□6
BGS

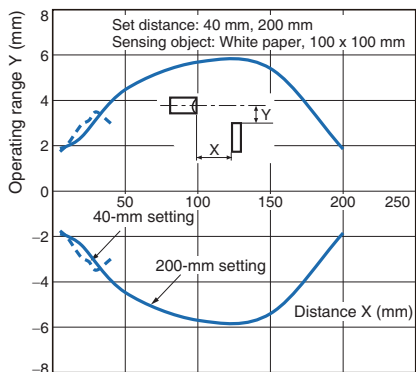

FGS

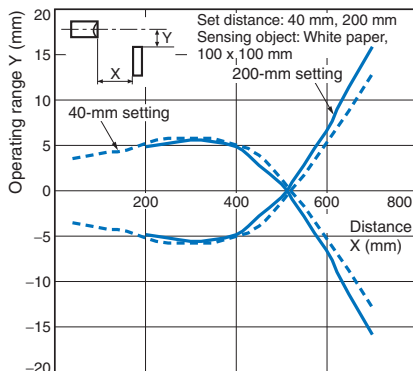

E3Z-LS□3/LS□8

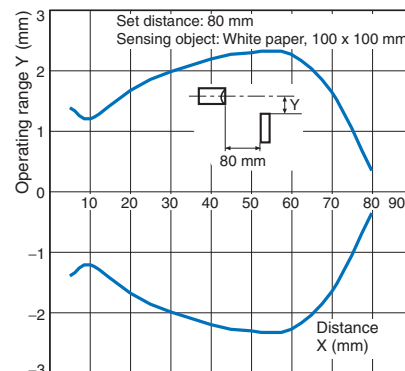

Spot Diameter vs. Sensing Distance

E3Z-LS□1/LS□6

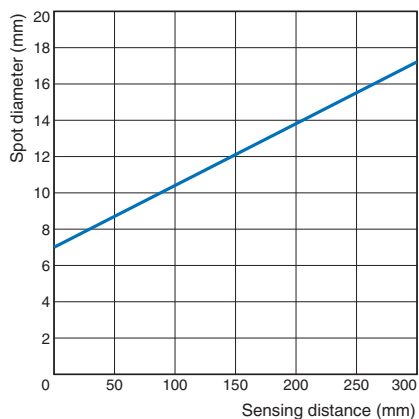

E3Z-LS□3/LS□8

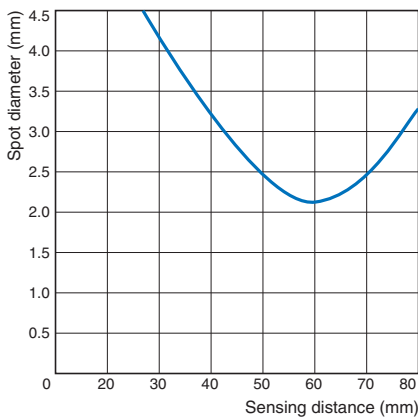

Close-range Characteristics

E3Z-LS□1/LS□6

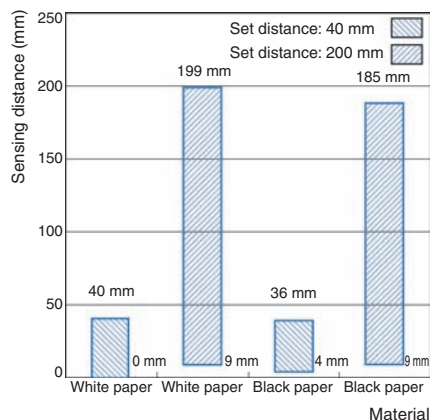

E3Z-LS□3/LS□8

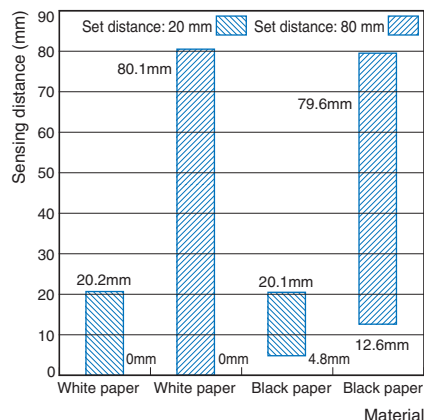

Differential Travel vs. Sensing Distance

E3Z-LS□1/LS□6

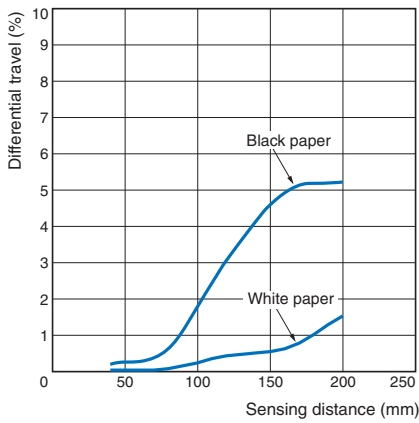

E3Z-LS□3/LS□8

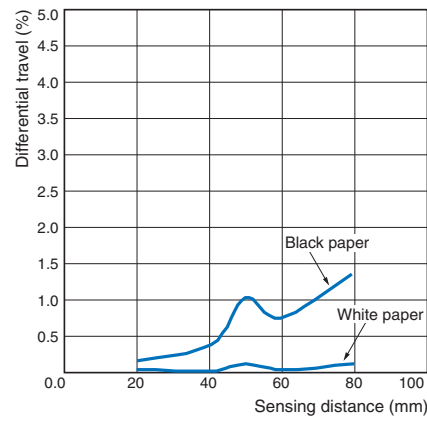

Sensing Object Angle Characteristics

E3Z-LS□1/LS□6

Vertical

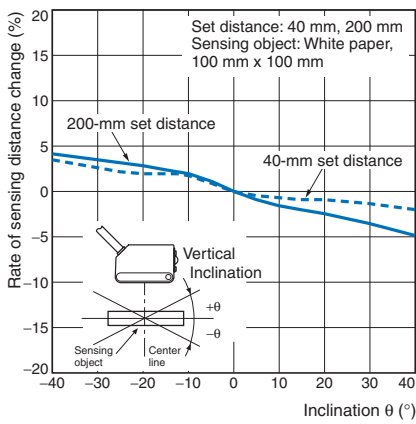

Horizontal

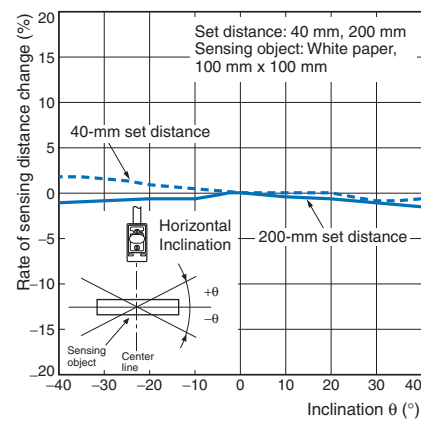

E3Z-LS□3/LS□8

Vertical

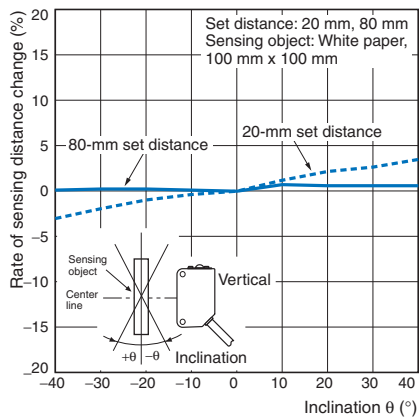

Horizontal

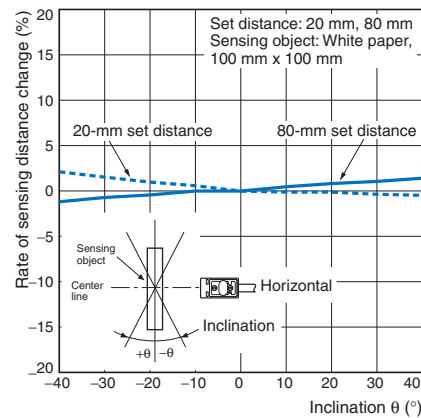

FGS Mode Set Distance

E3Z-LS□1/LS□6

White Paper

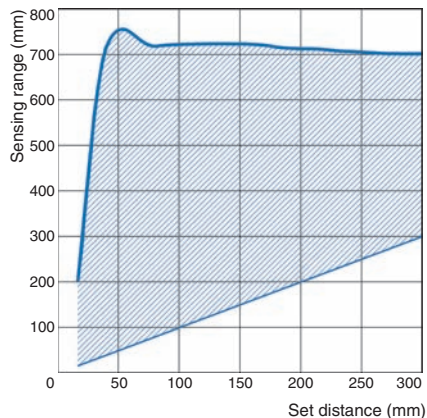

Black Paper

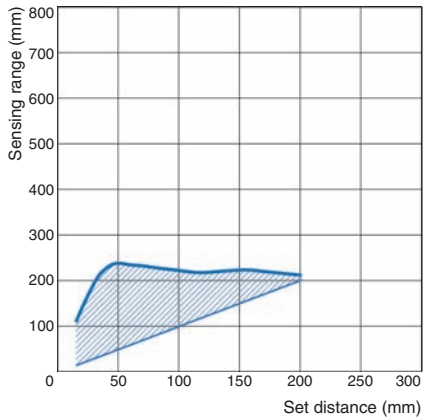

Sensing Distance vs. Sensing Object Material

E3Z-LS□1/LS□6

Set Distance of 40 mm using White Paper

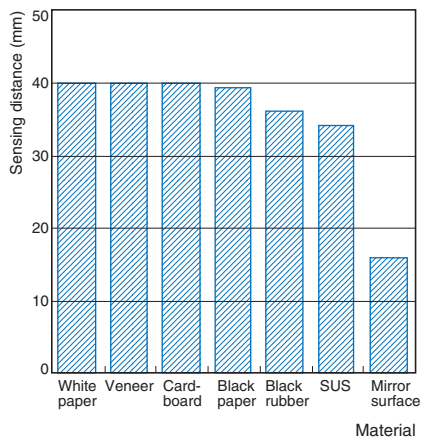

Set Distance of 200 mm using White Paper

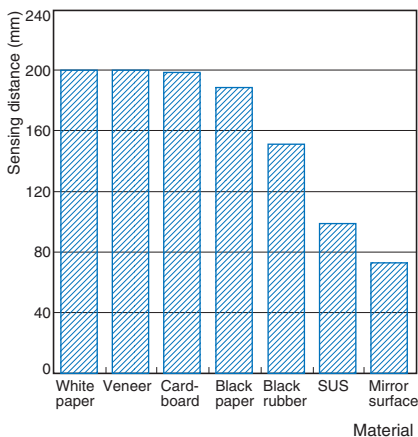

E3Z-LS□3/LS□8

Set Distance of 20 mm using White Paper

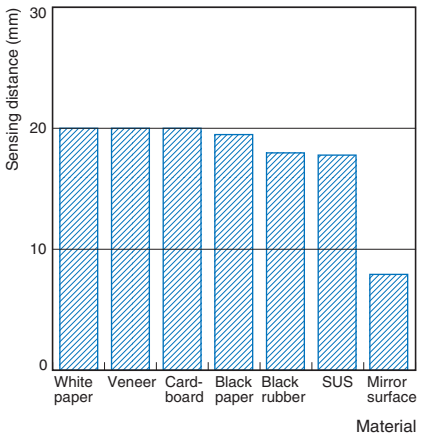

Set Distance of 80 mm using White Paper

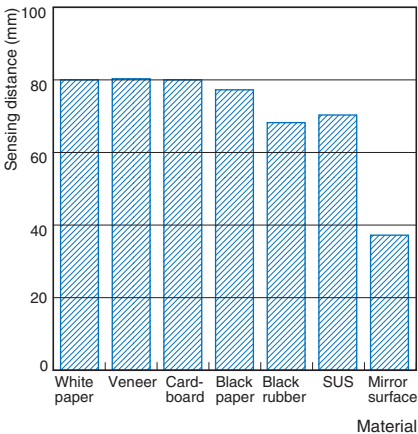

I/O Circuit Diagrams

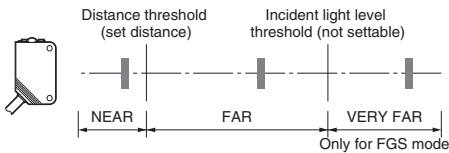

Note: The VERY FAR region is supported only for FGS.
The incident light level threshold is fixed and cannot be set.

NPN Output

Model	Operation mode	Timing charts	Operation selector	BGS/FGS selection method	Output circuit
E3Z-LS61 E3Z-LS66 E3Z-LS63 E3Z-LS68	Light-ON		L side (LIGHT ON)	BGS: Either leave the pink wire (2) open or connect it to the blue wire (3).	<p>Connector Pin Arrangement</p>
	Dark-ON		D side (DARK ON)		
E3Z-LS61 E3Z-LS66	Light-ON		L side (LIGHT ON)	FGS: Connect the pink wire (2) to the brown wire (1).	
	Dark-ON		D side (DARK ON)		

PNP Output

Model	Operation mode	Timing charts	Operation selector	BGS/FGS selection method	Output circuit
E3Z-LS81 E3Z-LS86 E3Z-LS83 E3Z-LS88	Light-ON		L side (LIGHT ON)	BGS: Either leave the pink wire (2) open or connect it to the blue wire (3).	<p>Connector Pin Arrangement</p>
	Dark-ON		D side (DARK ON)		
E3Z-LS81 E3Z-LS86	Light-ON		L side (LIGHT ON)	FGS: Connect the pink wire (2) to the brown wire (1).	
	Dark-ON		D side (DARK ON)		

Plugs (Sensor I/O Connectors)

M8 connector

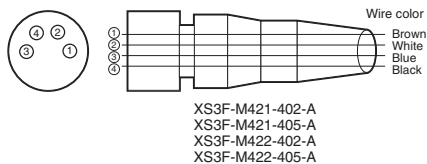

Pin arrangement

Classification	Wire color	Connector pin No.	Application
DC	Brown	1	Power supply (+V)
	White	2	BGS/FGS selection
	Blue	3	Power supply (0 V)
	Black	4	Output

Nomenclature

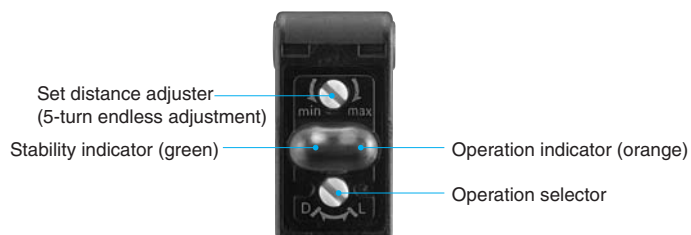

Safety Precautions

Refer to *Safety Precautions of the E3Z and Warranty and Limitations of Liability.*

⚠ WARNING

This product is not designed or rated for ensuring safety of persons either directly or indirectly. Do not use it for such purposes.



⚠ Caution

Do not connect an AC power supply to the Sensor. If AC power (100 VAC or more) is supplied to the Sensor, it may explode or burn.



Precautions for Safe Use

Be sure to abide by the following precautions for the safe operation of the Sensor.

● Wiring

Power Supply Voltage and Output Load Power Supply Voltage

Make sure that the power supply to the Sensor is within the rated voltage range. If a voltage exceeding the rated voltage range is supplied to the Sensor, it may explode or burn.

Load Short-circuiting

Do not short-circuit the load, otherwise the Sensor may be damaged.

Connection without Load

Do not connect the power supply to the Sensor with no load connected, otherwise the internal elements may explode or burn.

● Operating Environment

Do not use the Sensor in locations with explosive or flammable gas.

Precautions for Correct Use

Do not use the product in atmospheres or environments that exceed product ratings.

● Designing

Power Reset Time

The Sensor is ready to operate 100 ms after the Sensor is turned ON. If the load and Sensor are connected to independent power supplies respectively, be sure to turn ON the Sensor before supplying power to the load.

● Wiring

Avoiding Malfunctions

If using the Sensor with an inverter or servomotor, always ground the FG (frame ground) and G (ground) terminals, otherwise the Sensor may malfunction.

● Mounting

Mounting the Sensor

- If Sensors are mounted face-to-face, make sure that the optical axes are not in opposition to each other. Otherwise, mutual interference may result.
- Always install the Sensor carefully so that the aperture angle range of the Sensor will not cause it to be directly exposed to intensive light, such as sunlight, fluorescent light, or incandescent light.
- Do not strike the Photoelectric Sensor with a hammer or any other tool during the installation of the Sensor, or the Sensor will lose its water-resistive properties.
- Use M3 screws to mount the Sensor.
- When mounting the case, make sure that the tightening torque applied to each screw does not exceed 0.54 N·m.

M8 Connector

- Always turn OFF the power supply to the Sensor before connecting or disconnecting the metal connector.
 - Hold the connector cover to connect or disconnect it. If the XS3F is used, always tighten the connector cover by hand. Do not use pliers.
- If the connector is not connected securely, it may be disconnected by vibration or the proper degree of protection of the Sensor may not be maintained. The appropriate tightening torque is 0.3 to 0.4 N·m.
- If other commercially available connectors are used, follow the recommended connector application conditions and recommended tightening torque specifications.

Mounting Directions

- Make sure that the sensing side of the Sensor is parallel with the surface of the sensing objects. Normally, do not incline the Sensor towards the sensing object.

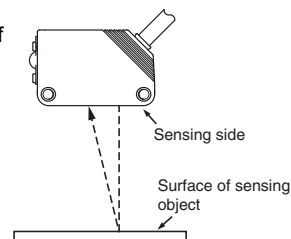

If the sensing object has a glossy surface, however, incline the Sensor by 5° to 10° as shown in the illustration, provided that the Sensor is not influenced by background objects.

- If there is a mirror-like object below the Sensor, the Sensor may not operate stably. Therefore, incline the Sensor or separate the Sensor from the mirror-like object as shown below.

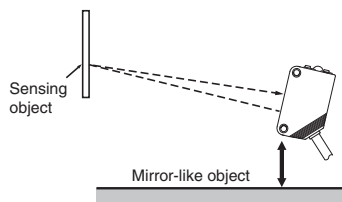
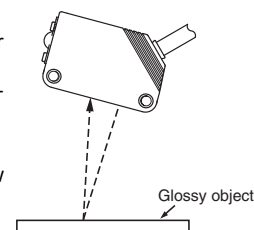

• Do not install the Sensor in the wrong direction. Refer to the following illustration.

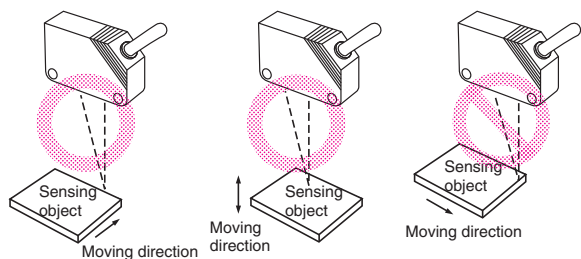

Install the Sensor as shown in the following illustration if each sensing object greatly differs in color or material.

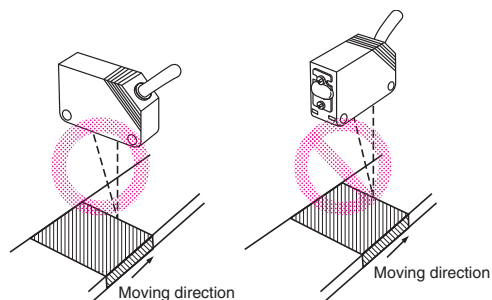

● Adjusting Indicator Operation

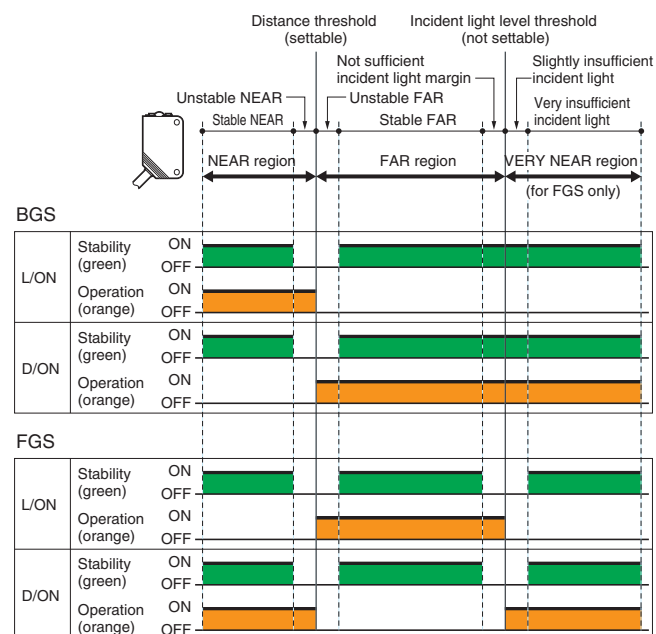

Note: 1. If the stability indicator is lit, the detection/no detection status is stable within the rated ambient operating temperature (-25 to 55°C).
 2. The VERY FAR region is supported only for FGS. The incident light threshold is fixed and cannot be set. The distance to the incident light threshold depends on the color and gloss of the sensing object's surface.

● Inspection and Maintenance

Cleaning

Never use paint thinners or other organic solvents to clean the surface of the product.

Dimensions

Pre-wired Models

E3Z-LS61
E3Z-LS81
E3Z-LS63
E3Z-LS83

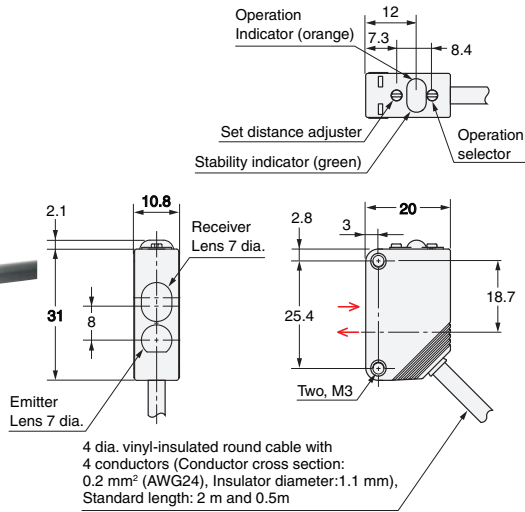

Connector Models

E3Z-LS66
E3Z-LS86
E3Z-LS68
E3Z-LS88

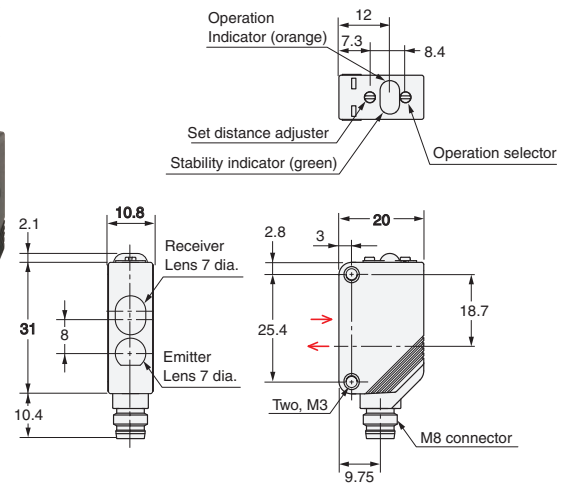

Terminal No.	Specifications
1	+V
2	BGS/FGS switchable
3	0 V
4	Output

Terms and Conditions Agreement

Read and understand this catalog.

Please read and understand this catalog before purchasing the products. Please consult your OMRON representative if you have any questions or comments.

Warranties.

(a) Exclusive Warranty. Omron's exclusive warranty is that the Products will be free from defects in materials and workmanship for a period of twelve months from the date of sale by Omron (or such other period expressed in writing by Omron). Omron disclaims all other warranties, express or implied.

(b) Limitations. OMRON MAKES NO WARRANTY OR REPRESENTATION, EXPRESS OR IMPLIED, ABOUT NON-INFRINGEMENT, MERCHANTABILITY OR FITNESS FOR A PARTICULAR PURPOSE OF THE PRODUCTS. BUYER ACKNOWLEDGES THAT IT ALONE HAS DETERMINED THAT THE PRODUCTS WILL SUITABLY MEET THE REQUIREMENTS OF THEIR INTENDED USE.

Omron further disclaims all warranties and responsibility of any type for claims or expenses based on infringement by the Products or otherwise of any intellectual property right. (c) Buyer Remedy. Omron's sole obligation hereunder shall be, at Omron's election, to (i) replace (in the form originally shipped with Buyer responsible for labor charges for removal or replacement thereof) the non-complying Product, (ii) repair the non-complying Product, or (iii) repay or credit Buyer an amount equal to the purchase price of the non-complying Product; provided that in no event shall Omron be responsible for warranty, repair, indemnity or any other claims or expenses regarding the Products unless Omron's analysis confirms that the Products were properly handled, stored, installed and maintained and not subject to contamination, abuse, misuse or inappropriate modification. Return of any Products by Buyer must be approved in writing by Omron before shipment. Omron Companies shall not be liable for the suitability or unsuitability or the results from the use of Products in combination with any electrical or electronic components, circuits, system assemblies or any other materials or substances or environments. Any advice, recommendations or information given orally or in writing, are not to be construed as an amendment or addition to the above warranty.

See <http://www.omron.com/global/> or contact your Omron representative for published information.

Limitation on Liability: Etc.

OMRON COMPANIES SHALL NOT BE LIABLE FOR SPECIAL, INDIRECT, INCIDENTAL, OR CONSEQUENTIAL DAMAGES, LOSS OF PROFITS OR PRODUCTION OR COMMERCIAL LOSS IN ANY WAY CONNECTED WITH THE PRODUCTS, WHETHER SUCH CLAIM IS BASED IN CONTRACT, WARRANTY, NEGLIGENCE OR STRICT LIABILITY.

Further, in no event shall liability of Omron Companies exceed the individual price of the Product on which liability is asserted.

Suitability of Use.

Omron Companies shall not be responsible for conformity with any standards, codes or regulations which apply to the combination of the Product in the Buyer's application or use of the Product. At Buyer's request, Omron will provide applicable third party certification documents identifying ratings and limitations of use which apply to the Product. This information by itself is not sufficient for a complete determination of the suitability of the Product in combination with the end product, machine, system, or other application or use. Buyer shall be solely responsible for determining appropriateness of the particular Product with respect to Buyer's application, product or system. Buyer shall take application responsibility in all cases.

NEVER USE THE PRODUCT FOR AN APPLICATION INVOLVING SERIOUS RISK TO LIFE OR PROPERTY OR IN LARGE QUANTITIES WITHOUT ENSURING THAT THE SYSTEM AS A WHOLE HAS BEEN DESIGNED TO ADDRESS THE RISKS, AND THAT THE OMRON PRODUCT(S) IS PROPERLY RATED AND INSTALLED FOR THE INTENDED USE WITHIN THE OVERALL EQUIPMENT OR SYSTEM.

Programmable Products.

Omron Companies shall not be responsible for the user's programming of a programmable Product, or any consequence thereof.

Performance Data.

Data presented in Omron Company websites, catalogs and other materials is provided as a guide for the user in determining suitability and does not constitute a warranty. It may represent the result of Omron's test conditions, and the user must correlate it to actual application requirements. Actual performance is subject to the Omron's Warranty and Limitations of Liability.

Change in Specifications.

Product specifications and accessories may be changed at any time based on improvements and other reasons. It is our practice to change part numbers when published ratings or features are changed, or when significant construction changes are made. However, some specifications of the Product may be changed without any notice. When in doubt, special part numbers may be assigned to fix or establish key specifications for your application. Please consult with your Omron's representative at any time to confirm actual specifications of purchased Product.

Errors and Omissions.

Information presented by Omron Companies has been checked and is believed to be accurate; however, no responsibility is assumed for clerical, typographical or proofreading errors or omissions.