

**OBSOLETE PRODUCT  
NO RECOMMENDED REPLACEMENT  
Call Central Applications 1-888-INTERSIL  
or email: centapp@intersil.com**

**Features**

- Six Matched Diodes on a Common Substrate
- Excellent Reverse Recovery Time . . . . . 1ns (Typ)
- $V_F$  Match . . . . . 5mV (Max)
- Low Capacitance . . . . .  $C_D = 0.65\text{pF}$  (Typ) at  $V_R = -2\text{V}$

**Applications**

- Ultra-Fast Low Capacitance Matched Diodes for Applications in Communications and Switching Systems
- Balanced Modulators or Demodulators
- Ring Modulators
- High Speed Diode Gates
- Analog Switches

**Description**

The CA3039 consists of six ultra-fast, low capacitance diodes on a common monolithic substrate. Integrated circuit construction assures excellent static and dynamic matching of the diodes, making the array extremely useful for a wide variety of applications in communication and switching systems.

Five of the diodes are independently accessible, the sixth shares a common terminal with the substrate.

For applications such as balanced modulators or ring modulators where capacitive balance is important, the substrate should be returned to a DC potential which is significantly more negative (with respect to the active diodes) than the peak signal applied.

**Part Number Information**

PART NUMBER	TEMP. RANGE (°C)	PACKAGE	PKG. NO.
CA3039	-55 to 125	12 Pin Metal Can	T12.B
CA3039M	-55 to 125	14 Ld SOIC	M14.15
CA3039M96	-55 to 125	14 Ld SOIC Tape and Reel	M14.15

**Pinouts**

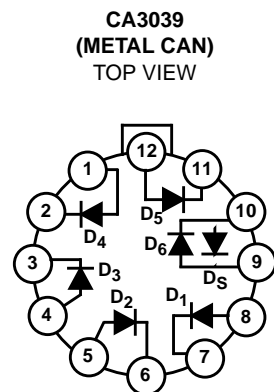
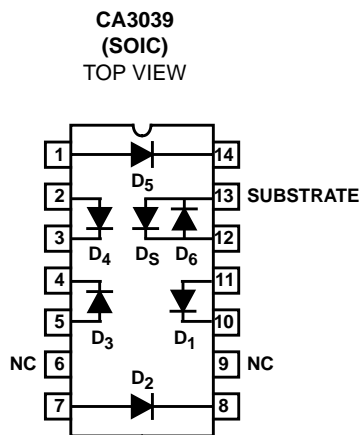

# CA3039

## Absolute Maximum Ratings

Inverse Voltage (PIV) for: D <sub>1</sub> - D <sub>5</sub> .....	5V
D <sub>6</sub> .....	0.5V
Diode-to-Substrate Voltage (V <sub>DI</sub> ) for D <sub>1</sub> - D <sub>5</sub> .....	20V, -1V (Terminal 1, 4, 5, 8 or 12 to Terminal 10)
DC Forward Current (I <sub>F</sub> ) .....	25mA
Recurrent Forward Current (I <sub>F</sub> ) .....	100mA
Forward Surge Current (I <sub>F(SURGE)</sub> ) .....	100mA

## Thermal Information

Thermal Resistance (Typical, Note 1)	$\theta_{JA}$ (°C/W)	$\theta_{JC}$ (°C/W)
Metal Can Package .....	200	120
SOIC Package .....	220	N/A
Maximum Power Dissipation (Any One Diode) .....	100mW	
Maximum Junction Temperature (Metal Can Package) .....	175°C	
Maximum Junction Temperature (Plastic Package) .....	150°C	
Maximum Storage Temperature Range .....	-65°C to 150°C	
Maximum Lead Temperature (Soldering 10s) .....	300°C (SOIC - Lead Tips Only)	

## Operating Conditions

Temperature Range .....

CAUTION: Stresses above those listed in "Absolute Maximum Ratings" may cause permanent damage to the device. This is a stress only rating and operation of the device at these or any other conditions above those indicated in the operational sections of this specification is not implied.

### NOTE:

- $\theta_{JA}$  is measured with the component mounted on an evaluation PC board in free air.

## Electrical Specifications $T_A = 25^\circ\text{C}$ ; Characteristics apply for each diode unit, Unless Otherwise Specified

PARAMETER	SYMBOL	TEST CONDITIONS	MIN	TYP	MAX	UNITS
DC Forward Voltage Drop (Figure 1)	$V_F$	$I_F = 50\mu\text{A}$	-	0.65	0.69	V
		$I_F = 1\text{mA}$	-	0.73	0.78	V
		$I_F = 3\text{mA}$	-	0.76	0.80	V
		$I_F = 10\text{mA}$	-	0.81	0.90	V
DC Reverse Breakdown Voltage	$V_{(BR)R}$	$I_R = -10\mu\text{A}$	5	7	-	V
DC Reverse Breakdown Voltage Between Any Diode Unit and Substrate	$V_{(BR)R}$	$I_R = -10\mu\text{A}$	20	-	-	V
DC Reverse (Leakage) Current (Figure 2)	$I_R$	$V_R = -4\text{V}$	-	0.016	100	nA
DC Reverse (Leakage) Current Between Any Diode Unit and Substrate (Figure 3)	$I_R$	$V_R = -10\text{V}$	-	0.022	100	nA
Magnitude of Diode Offset Voltage (Note 2) (Figure 1)	$ V_{F1} - V_{F2} $	$I_F = 1\text{mA}$	-	0.5	5.0	mV
Temperature Coefficient of $ V_{F1} - V_{F2} $ (Figure 4)	$\frac{\Delta V_{F1} - V_{F2} }{\Delta T}$	$I_F = 1\text{mA}$	-	1.0	-	$\mu\text{V}/^\circ\text{C}$
Temperature Coefficient of Forward Drop (Figure 5)	$\frac{\Delta V_F}{\Delta T}$	$I_F = 1\text{mA}$	-	-1.9	-	$\text{mV}/^\circ\text{C}$
DC Forward Voltage Drop for Anode-to-Substrate Diode (D <sub>S</sub> )	$V_F$	$I_F = 1\text{mA}$	-	0.65	-	V
Reverse Recovery Time	$t_{RR}$	$I_F = 10\text{mA}, I_R = -10\text{mA}$	-	1.0	-	ns
Diode Resistance (Figure 6)	$R_D$	$f = 1\text{kHz}, I_F = 1\text{mA}$	25	30	45	$\Omega$
Diode Capacitance (Figure 7)	$C_D$	$V_R = -2\text{V}, I_F = 0$	-	0.65	-	pF
Diode-to-Substrate Capacitance (Figure 8)	$C_{DI}$	$V_{DI} = 4\text{V}, I_F = 0$	-	3.2	-	pF

### NOTE:

- Magnitude of Diode Offset Voltage is the difference in DC Forward Voltage Drops of any two diode units.

Typical Performance Curves

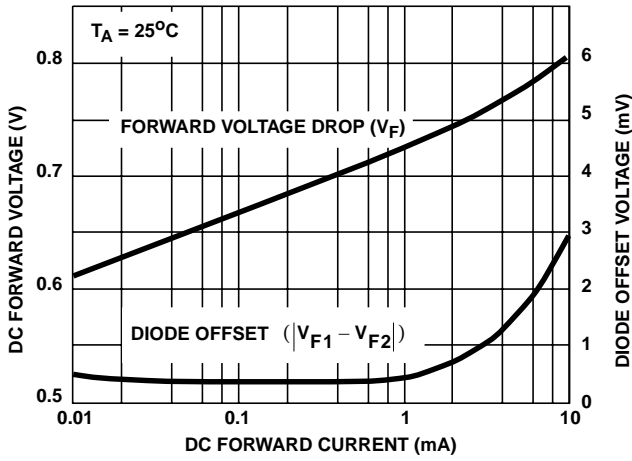

FIGURE 1. DC FORWARD VOLTAGE DROP (ANY DIODE) AND DIODE OFFSET VOLTAGE vs DC FORWARD CURRENT

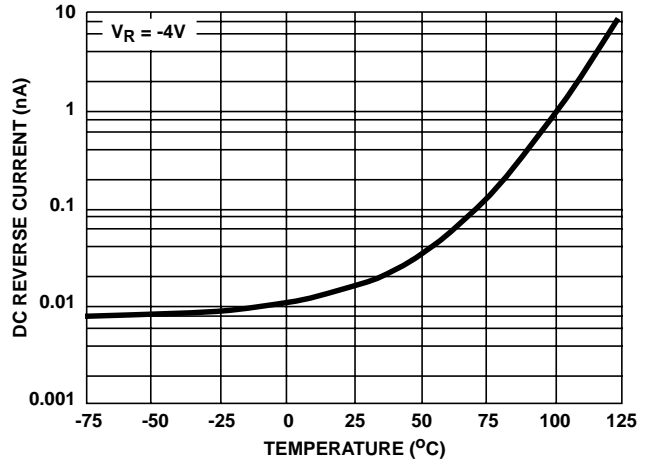

FIGURE 2. DC REVERSE (LEAKAGE) CURRENT ( $D_1 - D_5$ ) vs TEMPERATURE

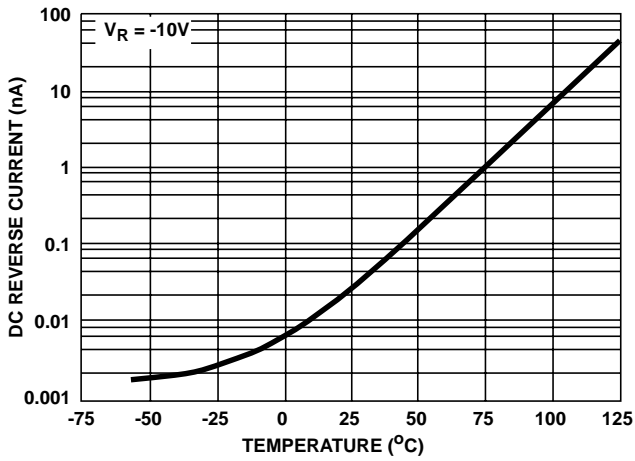

FIGURE 3. DC REVERSE (LEAKAGE) CURRENT BETWEEN  $D_1, D_2, D_3, D_4, D_5$  AND SUBSTRATE vs TEMPERATURE

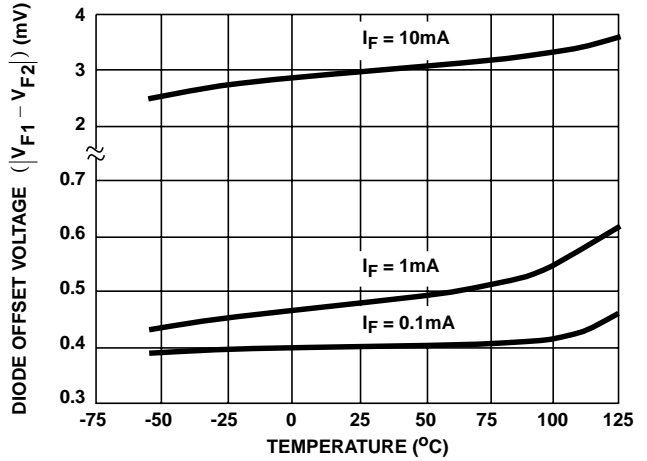
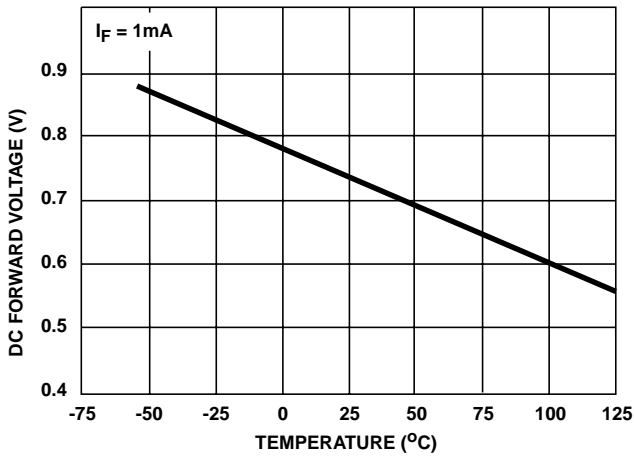
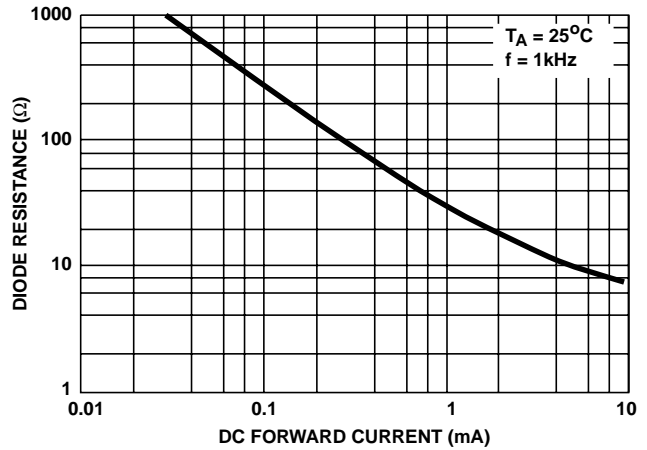

FIGURE 4. DIODE OFFSET VOLTAGE (ANY DIODE) vs TEMPERATURE

**Typical Performance Curves** (Continued)



**FIGURE 5. DC FORWARD VOLTAGE DROP (ANY DIODE) vs TEMPERATURE**



**FIGURE 6. DIODE RESISTANCE (ANY DIODE) vs DC FORWARD CURRENT**

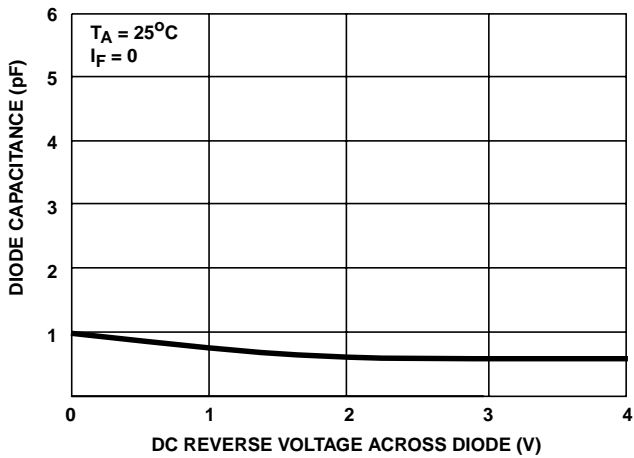

**FIGURE 7. DIODE CAPACITANCE (D<sub>1</sub> - D<sub>5</sub>) vs REVERSE VOLTAGE**

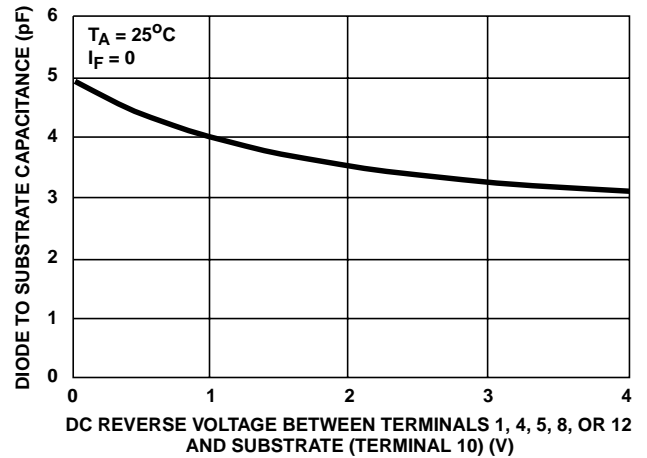

**FIGURE 8. DIODE-TO-SUBSTRATE CAPACITANCE vs REVERSE VOLTAGE**

All Intersil semiconductor products are manufactured, assembled and tested under **ISO9000** quality systems certification.

*Intersil semiconductor products are sold by description only. Intersil Corporation reserves the right to make changes in circuit design and/or specifications at any time without notice. Accordingly, the reader is cautioned to verify that data sheets are current before placing orders. Information furnished by Intersil is believed to be accurate and reliable. However, no responsibility is assumed by Intersil or its subsidiaries for its use; nor for any infringements of patents or other rights of third parties which may result from its use. No license is granted by implication or otherwise under any patent or patent rights of Intersil or its subsidiaries.*

For information regarding Intersil Corporation and its products, see web site [www.intersil.com](http://www.intersil.com)

**Sales Office Headquarters**

**NORTH AMERICA**  
Intersil Corporation  
P. O. Box 883, Mail Stop 53-204  
Melbourne, FL 32902  
TEL: (321) 724-7000  
FAX: (321) 724-7240

**EUROPE**  
Intersil SA  
Mercure Center  
100, Rue de la Fusee  
1130 Brussels, Belgium  
TEL: (32) 2.724.2111  
FAX: (32) 2.724.22.05

**ASIA**  
Intersil (Taiwan) Ltd.  
7F-6, No. 101 Fu Hsing North Road  
Taipei, Taiwan  
Republic of China  
TEL: (886) 2 2716 9310  
FAX: (886) 2 2715 3029