

**TPSMB-VR Series**



**Agency Recognitions**

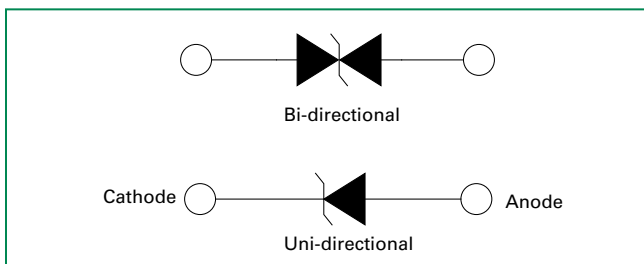
AGENCY	AGENCY FILE NUMBER
	E230531

**Maximum Ratings and Thermal Characteristics (T<sub>A</sub>=25°C unless otherwise noted)**

Parameter	Symbol	Value	Unit
Peak Pulse Power Dissipation by 10/1000µs waveform (Fig.1)(Note 1), (Note 2)	P <sub>PPM</sub>	600	W
Power Dissipation on infinite heat sink at T <sub>L</sub> =50°C	P <sub>M(AV)</sub>	5.0	W
Peak Forward Surge Current, 8.3ms Single Half Sine Wave (Note 3)	I <sub>FSM</sub>	100	A
Maximum Instantaneous Forward Voltage at 50A for Unidirectional only	V <sub>F</sub>	3.5V	V
Operating Junction Temperature Range (V <sub>R</sub> ≤ 78V)	T <sub>J</sub>	-65 to 175	°C
Operating Junction Temperature Range (V <sub>R</sub> > 78V)	T <sub>J</sub>	-65 to 150	°C
Storage Temperature Range	T <sub>STG</sub>	-65 to 175	°C
Typical Thermal Resistance Junction to Lead	R <sub>θJL</sub>	20	°C/W
Typical Thermal Resistance Junction to Ambient	R <sub>θJA</sub>	100	°C/W

- Notes:**
1. Non-repetitive current pulse per Fig. 4 and derated above T<sub>A</sub> = 25°C per Fig. 3.
  2. Mounted on copper pad area of 0.2x0.2" (5.0 x 5.0mm) to each terminal.
  3. Measured on 8.3ms single half sine wave or equivalent square wave for unidirectional component only, duty cycle=4 per minute maximum.

**Functional Diagram**



**Description**

The TPSMB-VR series is designed specifically to protect sensitive electronic equipment from voltage transients induced by lightning and other transient voltage events.


**Features**

- High reliability application and automotive grade AEC Q101 qualified
- Surface mount component to minimize board space
- Low profile package
- Typical failure mode is short from over-specified voltage or current
- Whisker test is conducted based on JEDEC JESD201A per its table 4a and 4c
- ESD protection of data lines in accordance with IEC 61000-4-2, 30kV(Air), 30kV (Contact)
- EFT protection of data lines in accordance with IEC 61000-4-4
- Glass passivated chip junction
- 600W peak pulse power capability at 10/1000µs waveform, repetition rate (duty cycles):0.01 %
- Fast response time: typically less than 1.0ns from 0V to V<sub>BR</sub> min
- Excellent clamping capability
- Low incremental surge resistance
- Typical I<sub>r</sub> ≤ 1µA for V<sub>R</sub> > 10V
- High temperature soldering guaranteed: 260°C/10 seconds at terminals
- UL Recognized compound meeting flammability rating V-0.
- Meet MSL level1, per J-STD-020, high temperature soldering guaranteed.
- Matte tin lead-free plated
- Halogen free and RoHS compliant
- Pb-free E3 means 2nd level interconnect is Pb-free and the terminal finish material is tin(Sn) (IPC/ JEDEC J-STD-609A.01)

**Applications**

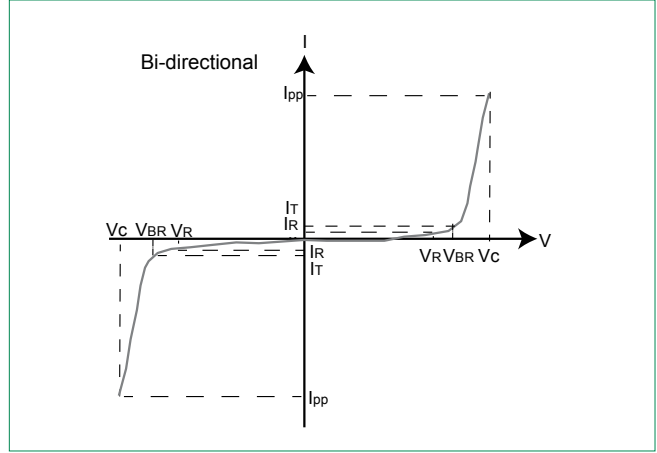
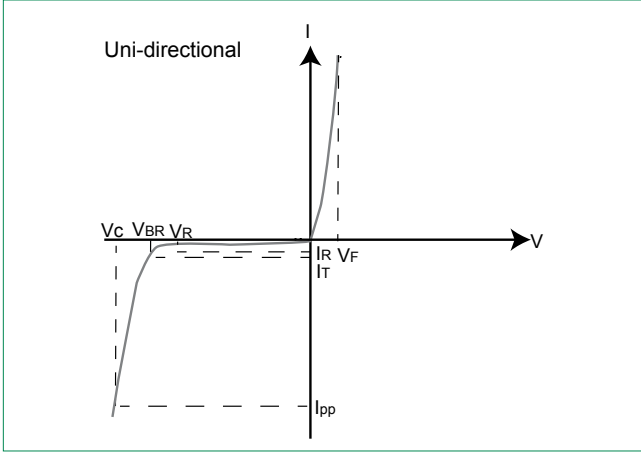
TVS components are ideal for the protection of I/O Interfaces, V<sub>CC</sub> bus and other vulnerable circuits used in Automotive applications.

**Electrical Characteristics** ( $T_A=25^\circ\text{C}$  unless otherwise noted)

Part Number (Uni)	Part Number (Bi)	Marking		Typical $I_R$ @ $150^\circ\text{C}$ ( $\mu\text{A}$ )	Reverse Stand off Voltage $V_R$ (Volts)	Breakdown Voltage $V_{BR}$ (Volts) @ $I_T$		Test Current $I_T$ (mA)	Maximum Clamping Voltage $V_C$ @ $I_{PP}$ (V)	Maximum Peak Pulse Current $I_{PP}$ (A)	Maximum Reverse Leakage $I_R$ @ $V_R$ ( $\mu\text{A}$ )	Maximum Temperature coefficient of $V_{BR}$ (%/C)	Agency Approval 
		UNI	BI			MIN	MAX						
TPSMB6.5A-VR	-	KKA	-	500	6.5	7.22	7.98	10	11.2	53.6	500	0.052	-
TPSMB7.0A-VR	-	KMA	-	200	7.0	7.78	8.60	10	12.0	50.0	200	0.058	-
TPSMB7.5A-VR	-	KPA	-	100	7.5	8.33	9.21	1	12.9	46.6	100	0.061	X
TPSMB8.0A-VR	-	KRA	-	50	8.0	8.89	9.83	1	13.6	44.2	50	0.064	-
TPSMB8.5A-VR	TPSMB8.5CA-VR	KTA	ATA	50	8.5	9.44	10.40	1	14.4	41.7	20	0.066	-
TPSMB9.0A-VR	TPSMB9.0CA-VR	KVA	AVA	20	9.0	10.00	11.10	1	15.4	39.0	10	0.069	-
TPSMB10A-VR	TPSMB10CA-VR	KXA	AXA	8	10.0	11.10	12.30	1	17.0	35.3	5	0.071	X
TPSMB11A-VR	TPSMB11CA-VR	KZA	AZA	8	11.0	12.20	13.50	1	18.2	33.0	1	0.074	X
TPSMB12A-VR	TPSMB12CA-VR	LEA	BEA	8	12.0	13.30	14.70	1	19.9	30.2	1	0.075	X
TPSMB13A-VR	TPSMB13CA-VR	LGA	BGA	8	13.0	14.40	15.90	1	21.5	28.0	1	0.076	X
TPSMB14A-VR	TPSMB14CA-VR	LKA	BKA	8	14.0	15.60	17.20	1	23.2	25.9	1	0.080	-
TPSMB15A-VR	TPSMB15CA-VR	LMA	BMA	8	15.0	16.70	18.50	1	24.4	24.6	1	0.083	X
TPSMB16A-VR	TPSMB16CA-VR	LPA	BPA	8	16.0	17.80	19.70	1	26.0	23.1	1	0.084	X
TPSMB17A-VR	TPSMB17CA-VR	LRA	BRA	8	17.0	18.90	20.90	1	27.6	21.8	1	0.085	-
TPSMB18A-VR	TPSMB18CA-VR	LTA	BTA	8	18.0	20.00	22.10	1	29.2	20.6	1	0.088	X
TPSMB20A-VR	TPSMB20CA-VR	LVA	BVA	8	20.0	22.20	24.50	1	32.4	18.6	1	0.091	X
TPSMB22A-VR	TPSMB22CA-VR	LXA	BXA	8	22.0	24.40	26.90	1	35.5	16.9	1	0.092	X
TPSMB24A-VR	TPSMB24CA-VR	LZA	BZA	8	24.0	26.70	29.50	1	38.9	15.5	1	0.092	X
TPSMB26A-VR	TPSMB26CA-VR	MEA	CEA	8	26.0	28.90	31.90	1	42.1	14.3	1	0.093	-
TPSMB28A-VR	TPSMB28CA-VR	MGA	CGA	8	28.0	31.10	34.40	1	45.4	13.3	1	0.094	-
TPSMB30A-VR	TPSMB30CA-VR	MKA	CKA	8	30.0	33.30	36.80	1	48.4	12.4	1	0.096	X
TPSMB33A-VR	TPSMB33CA-VR	MMA	CMA	8	33.0	36.70	40.60	1	53.3	11.3	1	0.097	X
TPSMB36A-VR	TPSMB36CA-VR	MPA	CPA	8	36.0	40.00	44.20	1	58.1	10.4	1	0.098	X
TPSMB40A-VR	TPSMB40CA-VR	MRA	CRA	8	40.0	44.40	49.10	1	64.5	9.3	1	0.099	-
TPSMB43A-VR	TPSMB43CA-VR	MTA	CTA	8	43.0	47.80	52.80	1	69.4	8.7	1	0.100	X
TPSMB45A-VR	TPSMB45CA-VR	MVA	CVA	8	45.0	50.00	55.30	1	72.7	8.3	1	0.101	-
TPSMB48A-VR	TPSMB48CA-VR	MXA	CXA	8	48.0	53.30	58.90	1	77.4	7.8	1	0.101	-
TPSMB51A-VR	TPSMB51CA-VR	MZA	CZA	8	51.0	56.70	62.70	1	82.4	7.3	1	0.101	X
TPSMB54A-VR	TPSMB54CA-VR	NEA	DEA	8	54.0	60.00	66.30	1	87.1	6.9	1	0.102	-
TPSMB58A-VR	TPSMB58CA-VR	NGA	DGA	8	58.0	64.40	71.20	1	93.6	6.5	1	0.103	-
TPSMB60A-VR	TPSMB60CA-VR	NKA	DKA	8	60.0	66.70	73.70	1	96.8	6.2	1	0.103	-
TPSMB64A-VR	TPSMB64CA-VR	NMA	DMA	8	64.0	71.10	78.60	1	103.0	5.9	1	0.104	-
TPSMB70A-VR	TPSMB70CA-VR	NPA	DPA	8	70.0	77.80	86.00	1	113.0	5.3	1	0.105	-
TPSMB75A-VR	TPSMB75CA-VR	NRA	DRA	8	75.0	83.30	92.10	1	121.0	5.0	1	0.106	X
TPSMB78A-VR	TPSMB78CA-VR	NTA	DTA	8	78.0	86.70	95.80	1	126.0	4.8	1	0.106	-
TPSMB85A-VR	TPSMB85CA-VR	NVA	DVA	8	85.0	94.40	104.00	1	137.0	4.4	1	0.106	-
TPSMB90A-VR	TPSMB90CA-VR	NXA	DXA	8	90.0	100.00	111.00	1	146.0	4.1	1	0.107	-
TPSMB100A-VR	TPSMB100CA-VR	NZA	DZA	8	100.0	111.00	123.00	1	162.0	3.7	1	0.107	X
TPSMB110A-VR	TPSMB110CA-VR	PEA	EEA	8	110.0	122.00	135.00	1	177.0	3.4	1	0.107	X
TPSMB120A-VR	TPSMB120CA-VR	PGA	EGA	8	120.0	133.00	147.00	1	193.0	3.1	1	0.108	X
TPSMB130A-VR	TPSMB130CA-VR	PKA	EKA	8	130.0	144.00	159.00	1	209.0	2.9	1	0.108	X
TPSMB150A-VR	TPSMB150CA-VR	PMA	EMA	8	150.0	167.00	185.00	1	243.0	2.5	1	0.108	X
TPSMB160A-VR	TPSMB160CA-VR	PPA	EPA	8	160.0	178.00	197.00	1	259.0	2.3	1	0.108	X
TPSMB170A-VR	TPSMB170CA-VR	PRA	ERA	8	170.0	189.00	209.00	1	275.0	2.2	1	0.108	X
TPSMB180A-VR	TPSMB180CA-VR	PTA	ETA	8	180.0	201.00	222.00	1	292.0	2.1	1	0.108	X
TPSMB188A-VR	TPSMB188CA-VR	PBA	EBA	8	188.0	209.00	231.00	1	304.0	2.0	1	0.110	-
TPSMB200A-VR	TPSMB200CA-VR	PVA	EVA	8	200.0	224.00	247.00	1	324.0	1.9	1	0.110	X
TPSMB220A-VR	TPSMB220CA-VR	PXA	EXA	8	220.0	246.00	272.00	1	356.0	1.7	1	0.110	X
TPSMB250A-VR	TPSMB250CA-VR	PZA	EZA	8	250.0	279.00	309.00	1	405.0	1.5	1	0.110	X
TPSMB300A-VR	TPSMB300CA-VR	QEA	FEA	8	300.0	335.00	371.00	1	486.0	1.3	1	0.112	X
TPSMB350A-VR	TPSMB350CA-VR	QGA	FGA	8	350.0	391.00	432.00	1	567.0	1.1	1	0.112	-
TPSMB400A-VR	TPSMB400CA-VR	QKA	FKA	8	400.0	447.00	494.00	1	648.0	0.9	1	0.112	-
TPSMB440A-VR	TPSMB440CA-VR	QMA	FMA	8	440.0	492.00	543.00	1	713.0	0.9	1	0.112	-

For bidirectional type having  $V_R$  of 10 volts and less, the  $I_R$  limit is double.  
 $V_{BR} @ T_j = V_{BR} @ 25^\circ\text{C} \times (1 + \alpha T \times (T_j - 25))$  ( $\alpha$ : Temperature Coefficient, typical value is 0.1%)

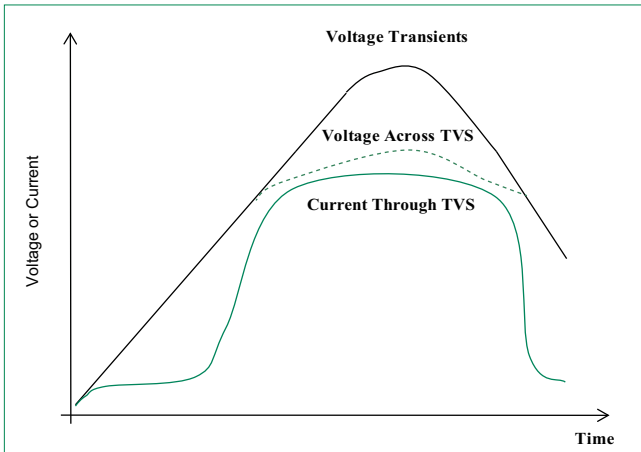
**I-V Curve Characteristics**



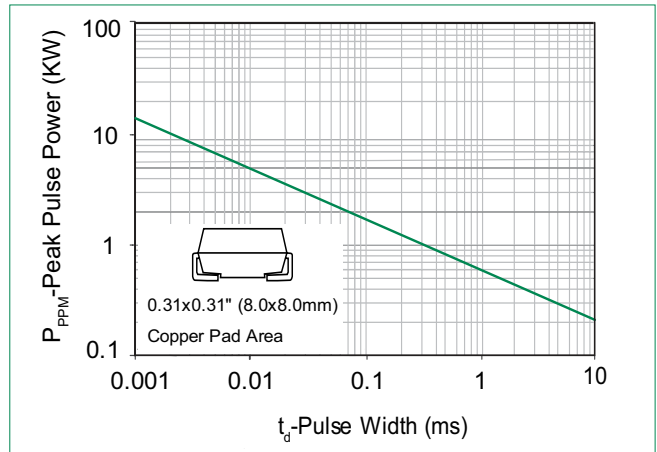
- $P_{PPM}$  Peak Pulse Power Dissipation** – Max power dissipation
- $V_R$  Stand-off Voltage** – Maximum voltage that can be applied to the TVS without operation
- $V_{BR}$  Breakdown Voltage** – Maximum voltage that flows through the TVS at a specified test current ( $I_T$ )
- $V_C$  Clamping Voltage** – Peak voltage measured across the TVS at a specified  $I_{ppm}$  (peak impulse current)
- $I_R$  Reverse Leakage Current** – Current measured at  $V_R$
- $V_F$  Forward Voltage Drop for Uni-directional**

**Ratings and Characteristic Curves** ( $T_A=25^\circ\text{C}$  unless otherwise noted)

**Figure 1 - TVS Transients Clamping Waveform**



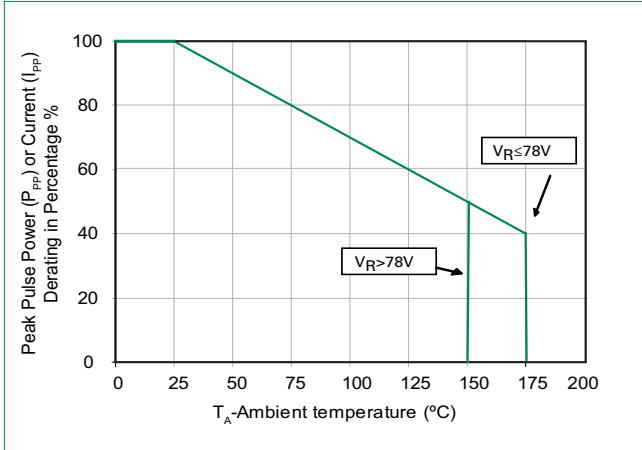
**Figure 2 - Peak Pulse Power Rating Curve**



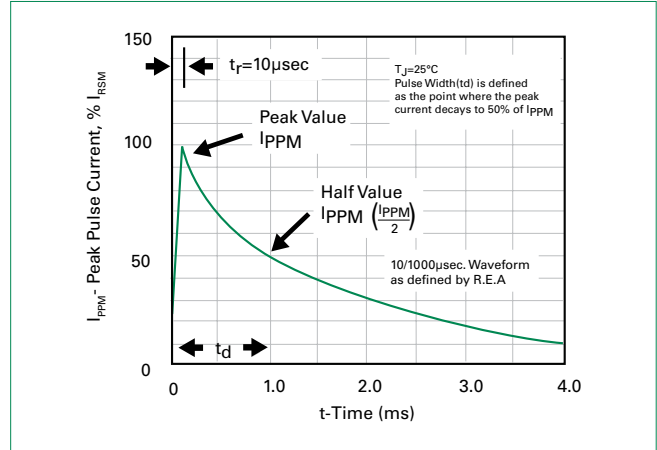
continues on next page.

**Ratings and Characteristic Curves** ( $T_A=25^\circ\text{C}$  unless otherwise noted) (Continued)

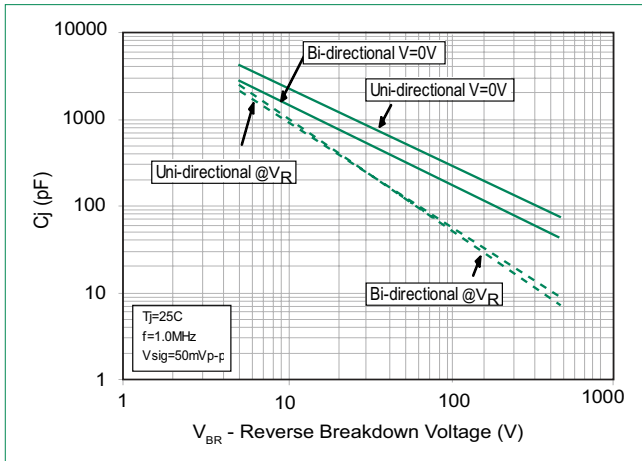
**Figure 3 - Peak Pulse Power Derating Curve**



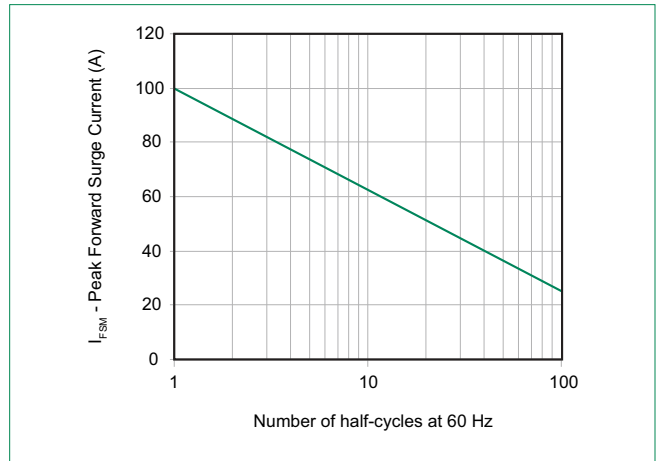
**Figure 4 - Pulse Waveform**



**Figure 5 - Typical Junction Capacitance**

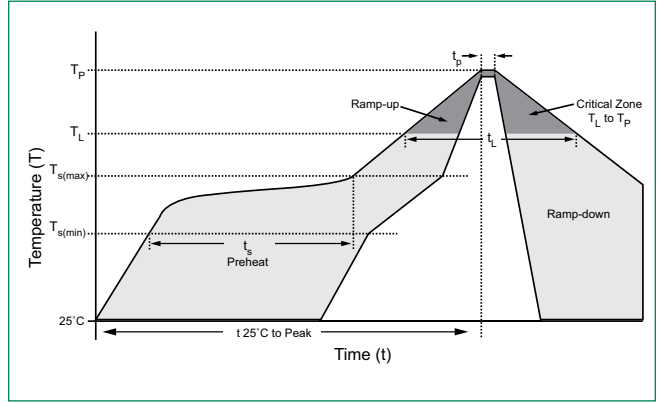


**Figure 6 - Maximum Non-Repetitive Peak Forward Surge Current Uni-Directional Only**



**Soldering Parameters**

<b>Reflow Condition</b>		Lead-free assembly
<b>Pre Heat</b>	- Temperature Min ( $T_{s(min)}$ )	150°C
	- Temperature Max ( $T_{s(max)}$ )	200°C
	- Time (min to max) ( $t_p$ )	60 – 120 secs
<b>Average ramp up rate (Liquidus Temp (<math>T_L</math>) to peak)</b>		3°C/second max
<b><math>T_{s(max)}</math> to <math>T_L</math> - Ramp-up Rate</b>		3°C/second max
<b>Reflow</b>	- Temperature ( $T_L$ ) (Liquidus)	217°C
	- Time (min to max) ( $t_p$ )	60 – 150 seconds
<b>Peak Temperature (<math>T_p</math>)</b>		260 <sup>+0/-5</sup> °C
<b>Time within 5°C of actual peak Temperature (<math>t_p</math>)</b>		30 seconds max
<b>Ramp-down Rate</b>		6°C/second max
<b>Time 25°C to peak Temperature (<math>T_p</math>)</b>		8 minutes max.
<b>Do not exceed</b>		260°C



**Physical Specifications**

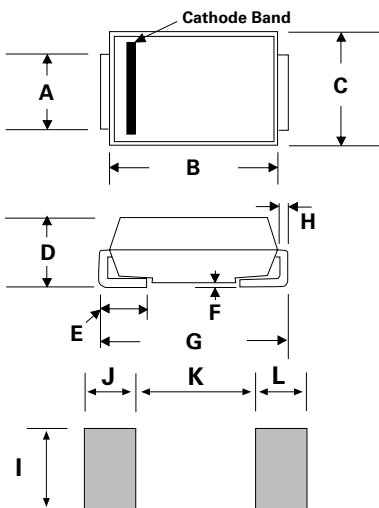
<b>Weight</b>	0.003 ounce, 0.093 grams
<b>Case</b>	JEDEC DO214AA. Molded plastic body over glass passivated junction
<b>Polarity</b>	Color band denotes cathode for unidirectional components
<b>Terminal</b>	Matte Tin-plated leads, Solderable per JESD22-B102

**Environmental Specifications**

<b>High Temp. Storage</b>	JESD22-A103
<b>HTRB</b>	JESD22-A108
<b>Temperature Cycling</b>	JESD22-A104
<b>MSL</b>	JEDEC-J-STD-020, Level 1
<b>H3TRB</b>	JESD22-A101
<b>RSH</b>	JESD22-A111

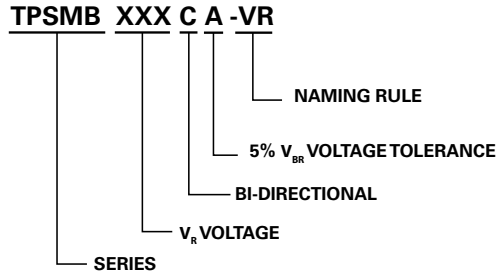
**Dimensions**

**DO-214AA (SMB J-Bend)**

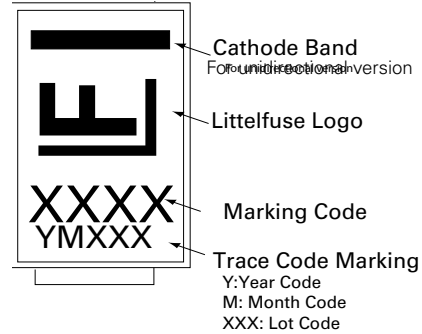


Dimensions	Inches		Millimeters	
	Min	Max	Min	Max
A	0.077	0.086	1.950	2.200
B	0.160	0.180	4.060	4.570
C	0.130	0.155	3.300	3.940
D	0.084	0.096	2.130	2.440
E	0.030	0.060	0.760	1.520
F	-	0.008	-	0.203
G	0.205	0.220	5.210	5.590
H	0.006	0.012	0.152	0.305
I	0.089	-	2.260	-
J	0.085	-	2.160	-
K	-	0.107	-	2.740
L	0.085	-	2.160	-

**Part Numbering System**



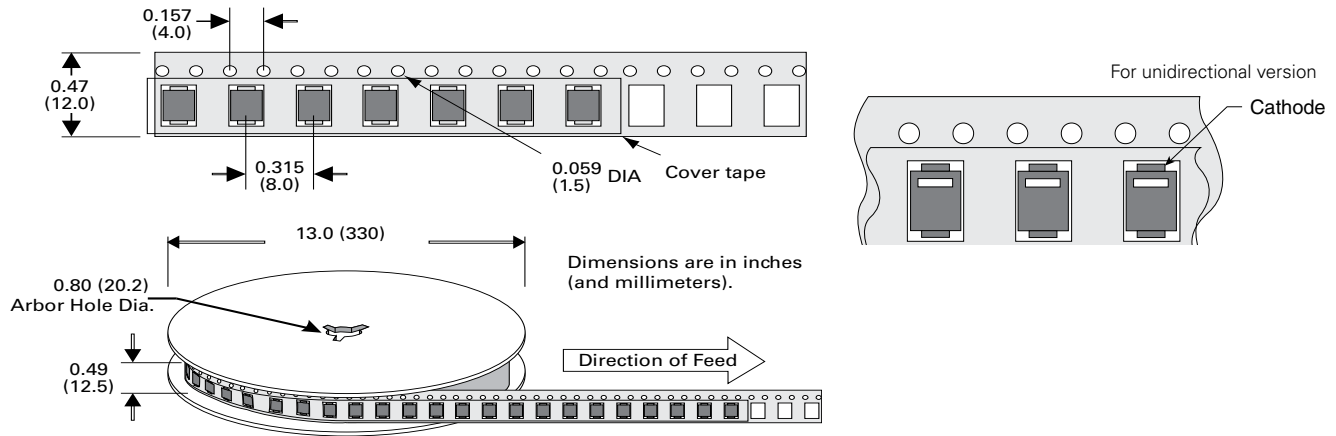
**Part Marking System**



**Packaging**

Part number	Component Package	Quantity	Packaging Option	Packaging Specification
TPSMBxxxXX-VR	DO-214AA	3000	Tape & Reel - 12mm tape/13" reel	EIA STD RS-481

**Tape and Reel Specification**



**Disclaimer Notice** - Information furnished is believed to be accurate and reliable. However, users should independently evaluate the suitability of and test each product selected for their own applications. Littelfuse products are not designed for, and may not be used in, all applications. Read complete Disclaimer Notice at <http://www.littelfuse.com/disclaimer-electronics>.