

HiPerFRED Module

$V_{RRM} = 400\text{ V}$
 $I_{FAV} = 2 \times 300\text{ A}$
 $t_{rr} = 60\text{ ns}$

Common Cathode

Part number

MEK600-04DA

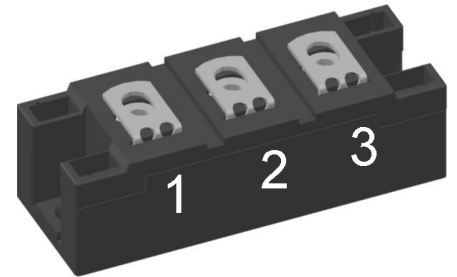

Backside: isolated

 E72873

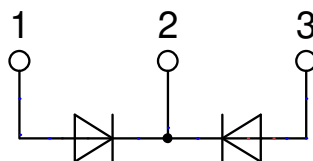

Features / Advantages:

- Planar passivated chips
- Low leakage current
- Very short recovery time
- Improved thermal behaviour
- Very low I_{rm} -values
- Very soft recovery behaviour
- Avalanche voltage rated for reliable operation
- Soft reverse recovery for low EMI/RFI
- Low I_{rm} reduces:
 - Power dissipation within the diode
 - Turn-on loss in the commutating switch

Applications:

- Antiparallel diode for high frequency switching devices
- Antisaturation diode
- Snubber diode
- Free wheeling diode
- Rectifiers in switch mode power supplies (SMPS)
- Uninterruptible power supplies (UPS)

Package: Y4

- Isolation Voltage: 3600 V~
- Industry standard outline
- RoHS compliant
- Height: 30 mm
- Base plate: DCB ceramic
- Reduced weight
- Advanced power cycling

Disclaimer Notice

Information furnished is believed to be accurate and reliable. However, users should independently evaluate the suitability of and test each product selected for their own applications. Littelfuse products are not designed for, and may not be used in, all applications. Read complete Disclaimer Notice at www.littelfuse.com/disclaimer-electronics.



Fast Diode				Ratings			
Symbol	Definition	Conditions	min.	typ.	max.	Unit	
V_{RSM}	max. non-repetitive reverse blocking voltage	$T_{VJ} = 25^{\circ}C$			400	V	
V_{RRM}	max. repetitive reverse blocking voltage	$T_{VJ} = 25^{\circ}C$			400	V	
I_R	reverse current, drain current	$V_R = 400 V$	$T_{VJ} = 25^{\circ}C$		6	mA	
		$V_R = 400 V$	$T_{VJ} = 125^{\circ}C$		18	mA	
V_F	forward voltage drop	$I_F = 300 A$	$T_{VJ} = 25^{\circ}C$		1.36	V	
		$I_F = 600 A$			1.79	V	
		$I_F = 300 A$	$T_{VJ} = 125^{\circ}C$		1.20	V	
		$I_F = 600 A$			1.68	V	
I_{FAV}	average forward current	$T_C = 95^{\circ}C$ rectangular $d = 0.5$	$T_{VJ} = 150^{\circ}C$		300	A	
V_{FO}	threshold voltage	} for power loss calculation only	$T_{VJ} = 150^{\circ}C$		0.74	V	
r_F	slope resistance				1.42	m Ω	
R_{thJC}	thermal resistance junction to case				0.11	K/W	
R_{thCH}	thermal resistance case to heatsink			0.08		K/W	
P_{tot}	total power dissipation		$T_C = 25^{\circ}C$		1100	W	
I_{FSM}	max. forward surge current	$t = 10 \text{ ms}; (50 \text{ Hz}), \text{ sine}; V_R = 0 \text{ V}$	$T_{VJ} = 45^{\circ}C$		3.00	kA	
C_J	junction capacitance	$V_R = 200 \text{ V}$ $f = 1 \text{ MHz}$	$T_{VJ} = 25^{\circ}C$		935	pF	
I_{RM}	max. reverse recovery current	} $I_F = 300 \text{ A}; V_R = 200 \text{ V}$ $-di_F / dt = 400 \text{ A}/\mu\text{s}$	$T_{VJ} = 25^{\circ}C$		29	A	
			$T_{VJ} = 125^{\circ}C$		58	A	
t_{rr}	reverse recovery time		$T_{VJ} = 25^{\circ}C$		60	ns	
			$T_{VJ} = 125^{\circ}C$		255	ns	



Package Y4				Ratings			
Symbol	Definition	Conditions	min.	typ.	max.	Unit	
I_{RMS}	RMS current	per terminal			300	A	
T_{VJ}	virtual junction temperature		-40		150	°C	
T_{op}	operation temperature		-40		125	°C	
T_{stg}	storage temperature		-40		125	°C	
Weight					150	g	
M_D	mounting torque		2.25		2.75	Nm	
M_T	terminal torque		4.5		5.5	Nm	
$d_{Spp/App}$	creepage distance on surface striking distance through air	terminal to terminal	14.0	10.0		mm	
$d_{Spb/Apb}$		terminal to backside	16.0	16.0		mm	
V_{ISOL}	isolation voltage	t = 1 second			3600	V	
		t = 1 minute	50/60 Hz, RMS; $I_{ISOL} \leq 1$ mA		3000	V	



Data Matrix: part no. (1-19), DC + PI (20-25), lot.no.# (26-31), blank (32), serial no.# (33-36)

Ordering	Ordering Number	Marking on Product	Delivery Mode	Quantity	Code No.
Standard	MEK600-04DA	MEK600-04DA	Box	6	485365

Equivalent Circuits for Simulation

* on die level

$T_{VJ} = 150$ °C

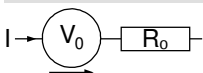

	Fast Diode	
$V_{0\ max}$	threshold voltage	0.74 V
$R_{0\ max}$	slope resistance *	0.17 mΩ



Outlines Y4



Dim.	MIN [mm]	MAX [mm]	MIN [inch]	MAX [inch]
a	30.0	30.6	1.181	1.205
b	typ. 0.25		typ. 0.010	
c	64.0	65.0	2.520	2.559
d	6.5	7.0	0.256	0.275
e	4.9	5.1	0.193	0.201
h	93.5	94.5	3.681	3.720
i	79.5	80.5	3.130	3.169
k	33.4	34.0	1.315	1.339
l	16.7	17.3	0.657	0.681
m	22.7	23.3	0.894	0.917
n	22.7	23.3	0.894	0.917
o	14.0	15.0	0.551	0.591
p	typ. 10.5		typ. 0.413	

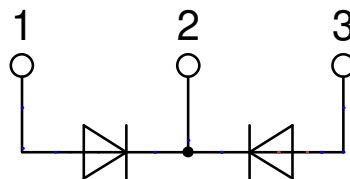
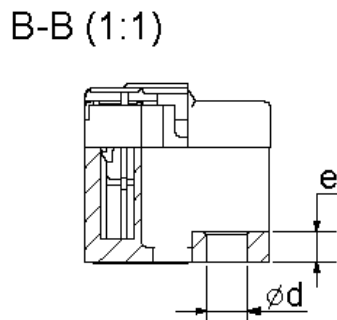



Fast Diode

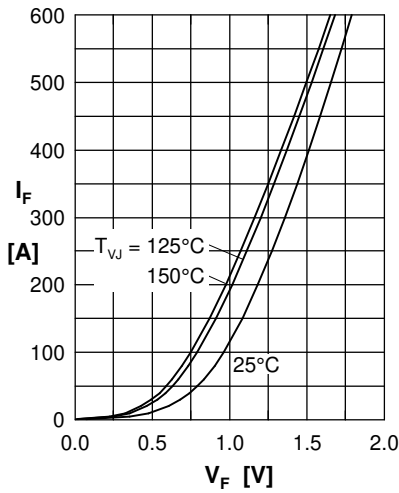

Fig. 1 Forward current I_F vs. V_F

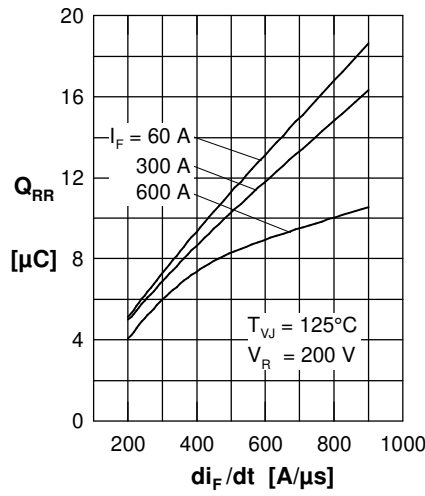

Fig. 2 Typ. reverse recovery charge Q_{RR} versus di_F/dt

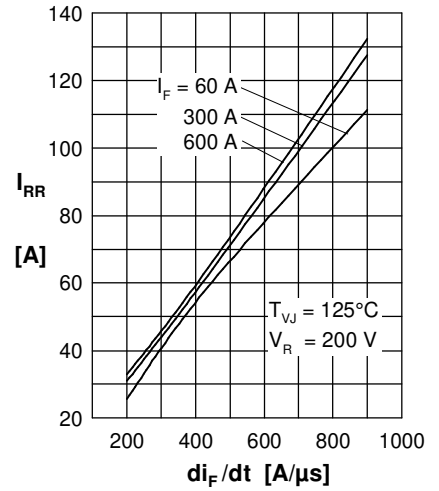

Fig. 3 Typ. reverse recovery current I_{RR} versus di_F/dt

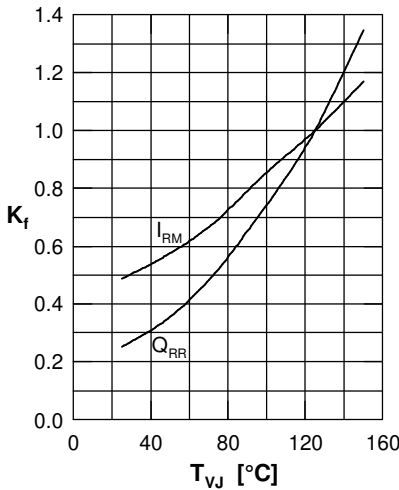

Fig. 4 Typ. dynamic parameters Q_{RR} , I_{RM} versus T_{VJ}

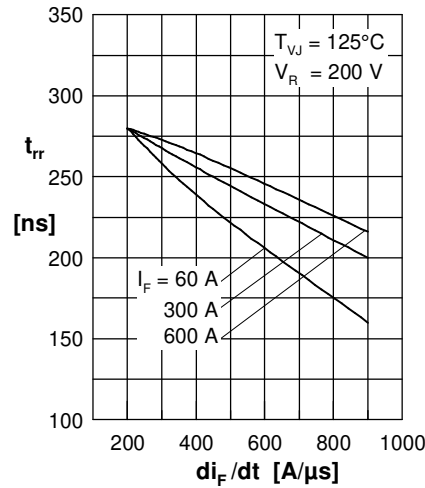

Fig. 5 Typ. reverse recovery time t_{rr} versus di_F/dt

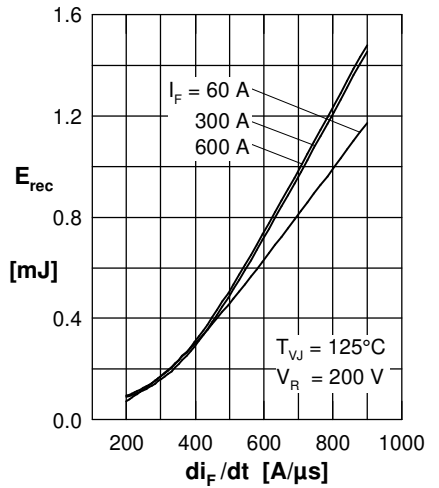

Fig. 7 Typ. recovery energy E_{rec} versus di_F/dt

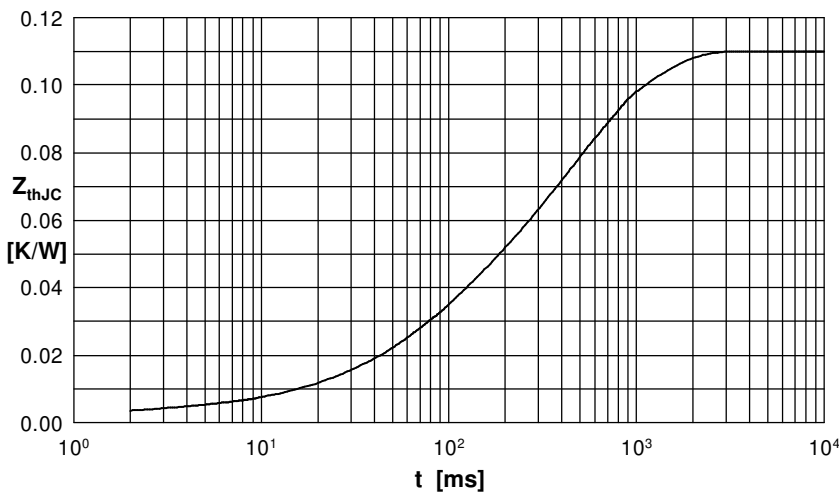

Fig. 8 Transient thermal impedance junction to case

R_{thi} [K/W]	t_i [s]
0.0030	0.001
0.0210	0.070
0.0390	0.380
0.0470	0.610