

36V 4W No-Opto Isolated Flyback Converter

FEATURES

- 4V to 36V Input Voltage Range
- 1.2A, 65V Internal DMOS Power Switch
- Low Quiescent Current
- Boundary Mode Operation at Heavy Load
- Low-Ripple Burst Mode® Operation at Light Load
- Minimum Load <0.5% (Typ) of Full Output
- V_{OUT} Set with a Single External Resistor
- No Transformer Third Winding or Opto-Isolator Required for Regulation
- Accurate EN/UVLO Threshold and Hysteresis
- Internal Compensation and Soft-Start
- Output Short-Circuit Protection
- 5-Lead TSOT-23 Package

APPLICATIONS

- Isolated Telecom, Automotive, Industrial, Medical Power Supplies
- Isolated Auxiliary/Housekeeping Power Supplies

DESCRIPTION

The LT[®]3001 is a micropower isolated flyback converter. By sampling the isolated output voltage directly from the primary-side flyback waveform, the part requires no third winding or opto-isolator for regulation. The output voltage is programmed with a single external resistor. Internal compensation and soft-start further reduce external component count. Boundary mode operation provides a small magnetic solution with excellent load regulation. Low ripple Burst Mode operation maintains high efficiency at light load while minimizing the output voltage ripple. A 1.2A, 65V DMOS power switch is integrated along with all high voltage circuitry and control logic into a 5-lead ThinSOT™ package.

The LT3001 operates from an input voltage range of 4V to 36V and can deliver up to 4W of isolated output power. The high level of integration and the use of boundary and low ripple burst modes result in a simple to use, low component count, and high efficiency application solution for isolated power delivery.

All registered trademarks and trademarks are the property of their respective owners. Protected by U.S. Patents, including 5438499, 7463497, and 7471522.

TYPICAL APPLICATION

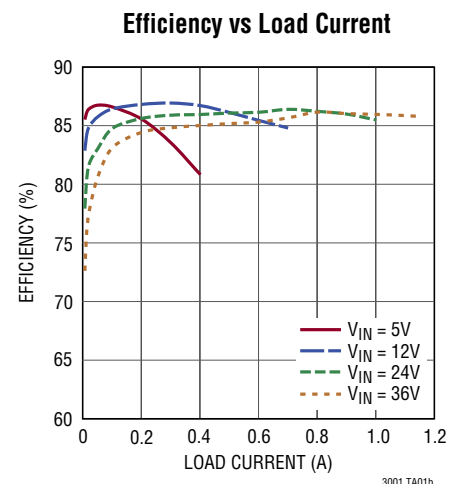
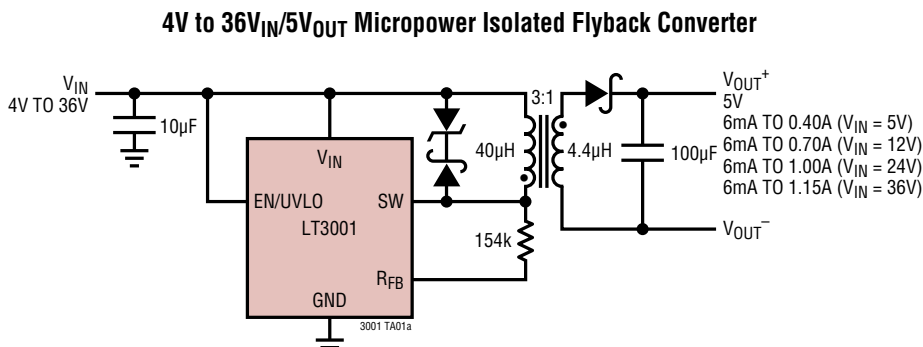

LT3001

ABSOLUTE MAXIMUM RATINGS

(Note 1)

SW (Note 2)	65V	
V_{IN}	42V	
EN/UVLO	V_{IN}	
R_{FB}	$V_{IN} - 0.5V$ to V_{IN}	
Current into R_{FB}	200 μ A	
Operating Junction Temperature Range (Notes 3, 4)		
LT3001E, LT3001I	-40°C to 125°C	
Storage Temperature Range		-65°C to 150°C

PIN CONFIGURATION

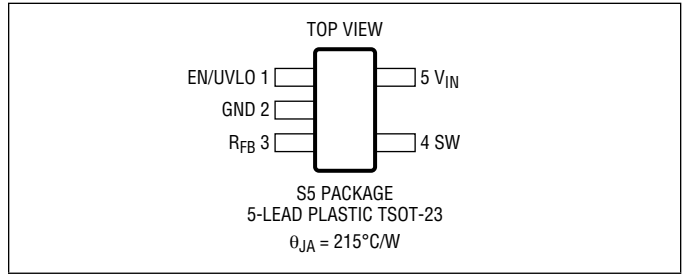

ORDER INFORMATION

LEAD FREE FINISH	TAPE AND REEL	PART MARKING*	PACKAGE DESCRIPTION	TEMPERATURE RANGE
LT3001ES5#TRMPBF	LT3001ES5#TRPBF	LTHMF	5-Lead Plastic TSOT-23	-40°C to 125°C
LT3001IS5#TRMPBF	LT3001IS5#TRPBF	LTHMF	5-Lead Plastic TSOT-23	-40°C to 125°C

Contact the factory for parts specified with wider operating temperature ranges. *The temperature grade is identified by a label on the shipping container.

[Tape and reel specifications](#). Some packages are available in 500 unit reels through designated sales channels with #TRMPBF suffix.

ELECTRICAL CHARACTERISTICS The ● denotes the specifications which apply over the full operating temperature range, otherwise specifications are at $T_A = 25^\circ\text{C}$. $V_{IN} = 5\text{V}$, $V_{EN/UVLO} = V_{IN}$ unless otherwise noted.

SYMBOL	PARAMETER	CONDITIONS	MIN	TYP	MAX	UNIT
V_{IN}	Input Voltage Range		4		36	V
I_Q	V_{IN} Quiescent Current	$V_{EN/UVLO} = 0.2\text{V}$ Active Mode		0.8 350	2	μA μA
	EN/UVLO Shutdown Threshold	For Lowest Off I_Q	0.2	0.55		V
	EN/UVLO Enable Threshold	Falling Hysteresis	1.204	1.228 0.014	1.248	V V
I_{HYS}	EN/UVLO Hysteresis Current	$V_{EN/UVLO} = 1.1\text{V}$ $V_{EN/UVLO} = 1.3\text{V}$	2.2 -0.1	2.5 0	2.8 0.1	μA μA
f_{MIN}	Minimum Switching Frequency		9.4	10	10.6	kHz
$t_{ON(MIN)}$	Minimum Switch-On Time			170		ns
$I_{SW(MAX)}$	Maximum SW Current Limit		1.200	1.375	1.550	A
$I_{SW(MIN)}$	Minimum SW Current Limit		0.22	0.29	0.36	A
$R_{DS(ON)}$	Switch On-Resistance	$I_{SW} = 500\text{mA}$		0.4		Ω
I_{RFB}	R_{FB} Regulation Current		● 97.5	100	102.5	μA

Note 1: Stresses beyond those listed under Absolute Maximum Ratings may cause permanent damage to the device. Exposure to any Absolute Maximum Rating condition for extended periods may affect device reliability and lifetime.

Note 2: The SW pin is rated to 65V for transients. Depending on the leakage inductance voltage spike, operating waveforms of the SW pin should be derated to keep the flyback voltage spike below 65V.

Note 3: The LT3001E is guaranteed to meet performance specifications from 0°C to 125°C operating junction temperature. Specifications over the -40°C to 125°C operating junction temperature range are assured by design, characterization and correlation with statistical process controls. The LT3001I is guaranteed over the full -40°C to 125°C operating junction temperature range.

Note 4: The LT3001 includes overtemperature protection that is intended to protect the device during momentary overload conditions. Junction temperature will exceed 150°C when overtemperature protection is active. Continuous operation above the specified maximum operating junction temperature may impair device reliability.

TYPICAL PERFORMANCE CHARACTERISTICS $T_A = 25^\circ\text{C}$, unless otherwise noted.

Output Load and Line Regulation

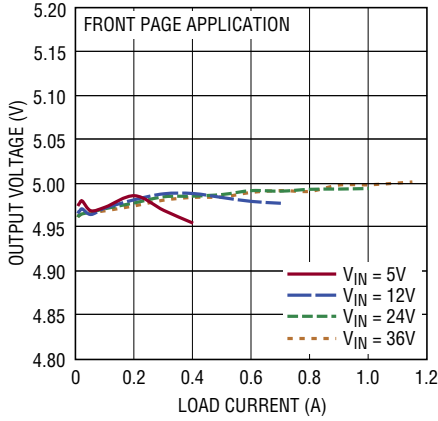

Output Short-Circuit Protection

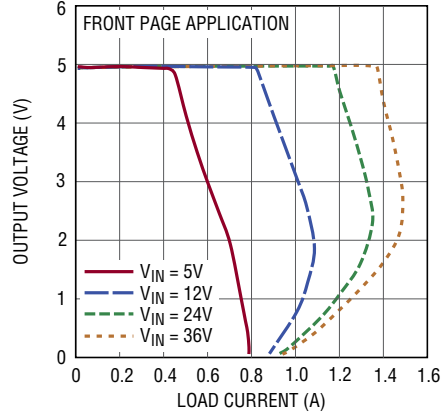

Switching Frequency vs Load Current

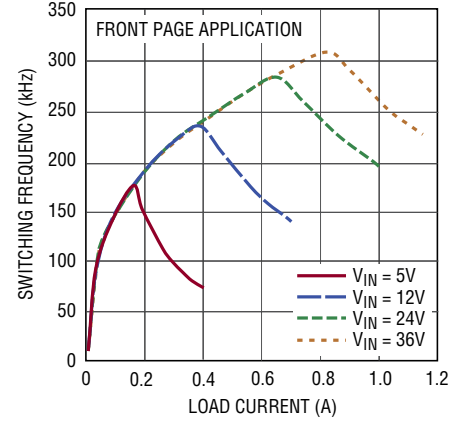

Boundary Mode Waveforms

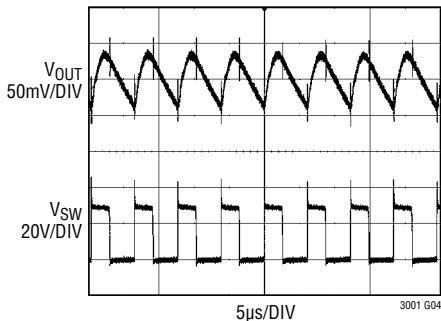

FRONT PAGE APPLICATION
 $V_{IN} = 12\text{V}$
 $I_{LOAD} = 600\text{mA}$

Discontinuous Mode Waveforms

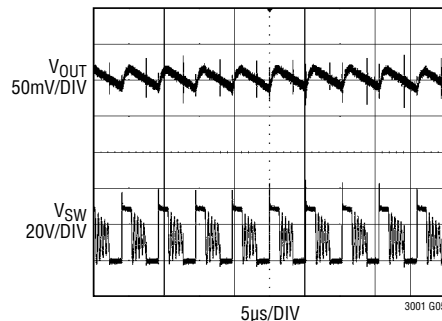

FRONT PAGE APPLICATION
 $V_{IN} = 12\text{V}$
 $I_{LOAD} = 200\text{mA}$

Burst Mode Waveforms

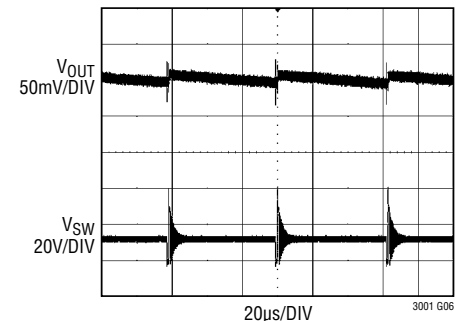

FRONT PAGE APPLICATION
 $V_{IN} = 12\text{V}$
 $I_{LOAD} = 6\text{mA}$

EN/UVLO Enable Threshold

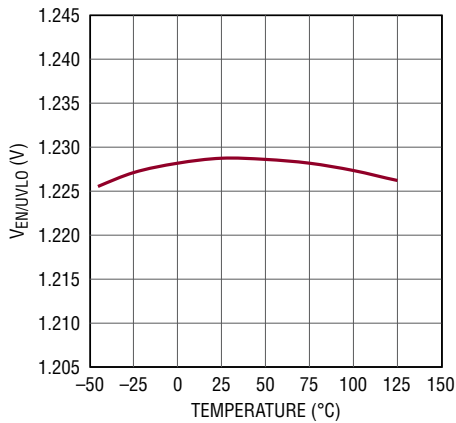

R_{FB} Regulation Current

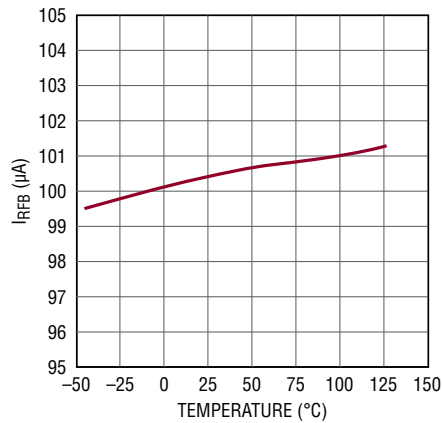

Switch Current Limit

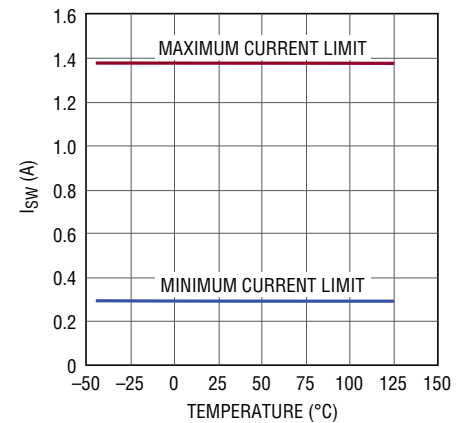

PIN FUNCTIONS

EN/UVLO (Pin 1): Enable/Undervoltage Lockout. The EN/UVLO pin is used to enable the LT3001. Pull the pin below 0.2V to shut down the LT3001. This pin has an accurate 1.228V threshold and can be used to program a V_{IN} undervoltage lockout (UVLO) threshold using a resistor divider from V_{IN} to ground. A 2.5 μ A current hysteresis allows the programming of V_{IN} UVLO hysteresis. If neither function is used, tie this pin directly to V_{IN} .

GND (Pin 2): Ground. Tie this pin directly to local ground plane.

R_{FB} (Pin 3): Input Pin for External Feedback Resistor. Connect a resistor from this pin to the transformer primary

SW pin. The ratio of the R_{FB} resistor to an internal 10k resistor, times a trimmed 1.0V reference voltage, determines the output voltage (plus the effect of any non-unity transformer turns ratio). Minimize trace area at this pin.

SW (Pin 4): Drain of the 65V Internal DMOS Power Switch. Minimize trace area at this pin to reduce EMI and voltage spikes.

V_{IN} (Pin 5): Input Supply. The V_{IN} pin supplies current to internal circuitry and serves as a reference voltage for the feedback circuitry connected to the R_{FB} pin. Locally bypass this pin to ground with a capacitor.

OPERATION

The LT3001 is a current mode switching regulator IC designed specially for the isolated flyback topology. The key problem in isolated topologies is how to communicate the output voltage information from the isolated secondary side of the transformer to the primary side for regulation. Historically, opto-isolators or extra transformer windings communicate this information across the isolation boundary. Opto-isolator circuits waste output power, and the extra components increase the cost and physical size of the power supply. Opto-isolators can also cause system issues due to limited dynamic response, nonlinearity, unit-to-unit variation and aging over lifetime. Circuits employing extra transformer windings also exhibit deficiencies, as using an extra winding adds to the transformer's physical size and cost, and dynamic response is often mediocre.

The LT3001 samples the isolated output voltage through the primary-side flyback pulse waveform. In this manner, neither opto-isolator nor extra transformer winding is required for regulation. Since the LT3001 operates in either boundary conduction mode or discontinuous conduction mode, the output voltage is always sampled on the SW pin when the secondary current is zero. This method improves load regulation without the need of external load compensation components.

APPLICATIONS INFORMATION

Output Voltage

The R_{FB} resistor is the only external resistor used to program the output voltage.

The output voltage is set by:

$$V_{OUT} = 100\mu A \cdot \left(\frac{R_{FB}}{N_{PS}} \right) - V_F$$

V_F = Output diode forward voltage

N_{PS} = Transformer effective primary-to-secondary turns ratio

Primary Inductance Requirement

The LT3001 obtains output voltage information from the reflected output voltage on the SW pin. The conduction of secondary current reflects the output voltage on the primary SW pin. The sample-and-hold error amplifier needs a minimum 450ns to settle and sample the reflected output voltage. In order to ensure proper sampling, the secondary winding needs to conduct current for a minimum of 450ns. The following equation gives the minimum value for primary-side magnetizing inductance:

$$L_{PRI} \geq \frac{t_{OFF(MIN)} \cdot N_{PS} \cdot (V_{OUT} + V_F)}{I_{SW(MIN)}}$$

$t_{OFF(MIN)}$ = Minimum switch-off time = 450ns

$I_{SW(MIN)}$ = Minimum switch current limit = 290mA (typ)

In addition to the primary inductance requirement for the minimum switch-off time, the LT3001 has minimum switch-on time that prevents the chip from turning on the power switch shorter than approximately 170ns. This minimum switch-on time is mainly for leading-edge blanking the initial switch turn-on current spike. If the inductor current exceeds the desired current limit during that time, oscillation may occur at the output as the current control loop will lose its ability to regulate. Therefore, the following equation relating to maximum input voltage

must also be followed in selecting primary-side magnetizing inductance:

$$L_{PRI} \geq \frac{t_{ON(MIN)} \cdot V_{IN(MAX)}}{I_{SW(MIN)}}$$

$t_{ON(MIN)}$ = Minimum switch-on time = 170ns

Undervoltage Lockout (UVLO)

A resistive divider from V_{IN} to the EN/UVLO pin implements undervoltage lockout (UVLO). The EN/UVLO pin falling threshold is set at 1.228V with 14mV hysteresis. In addition, the EN/UVLO pin sinks 2.5 μ A when the voltage at the pin is below 1.228V. This current provides user programmable hysteresis based on the value of R1. The programmable UVLO thresholds are:

$$V_{IN(UVLO+)} = \frac{1.242V \cdot (R1 + R2)}{R2} + 2.5\mu A \cdot R1$$

$$V_{IN(UVLO-)} = \frac{1.228V \cdot (R1 + R2)}{R2}$$

Figure 1 shows the implementation of external shutdown control while still using the UVLO function. The NMOS grounds the EN/UVLO pin when turned on, and puts the LT3001 in shutdown with quiescent current less than 2 μ A.

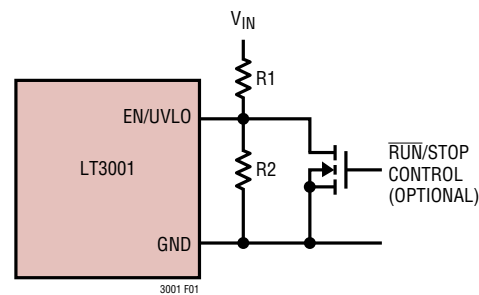

Figure 1. Undervoltage Lockout (UVLO)

APPLICATIONS INFORMATION

Minimum Load Requirement

The LT3001 samples the isolated output voltage from the primary-side flyback pulse waveform. The flyback pulse occurs once the primary switch turns off and the secondary winding conducts current. In order to sample the output voltage, the LT3001 has to turn on and off at least for a minimum amount of time and with a minimum frequency. The LT3001 delivers a minimum amount of energy even during light load conditions to ensure accurate output voltage information. The minimum energy delivery creates a minimum load requirement, which can be approximately estimated as:

$$I_{LOAD(MIN)} = \frac{L_{PRI} \cdot I_{SW(MIN)}^2 \cdot f_{MIN}}{2 \cdot V_{OUT}}$$

L_{PRI} = Transformer primary inductance

$I_{SW(MIN)}$ = Minimum switch current limit = 360mA (max)

f_{MIN} = Minimum switching frequency = 10.6kHz (max)

The LT3001 typically needs less than 0.5% of its full output power as minimum load. Alternatively, a Zener diode with its breakdown of 20% higher than the output voltage can serve as a minimum load if pre-loading is not acceptable. For a 5V output, use a 6V Zener with cathode connected to the output.

Design Example

Use the following design example as a guide to design applications for the LT3001. The design example involves designing a 5V output with a 500mA load current and an input range from 8V to 32V.

$$V_{IN(MIN)} = 8V, V_{IN(NOM)} = 12V, V_{IN(MAX)} = 32V, \\ V_{OUT} = 5V, I_{OUT} = 500mA$$

Step 1: Select the Transformer Turns Ratio.

$$N_{PS} < \frac{65V - V_{IN(MAX)} - V_{LEAKAGE}}{V_{OUT} + V_F}$$

$V_{LEAKAGE}$ = Margin for transformer leakage spike = 15V

V_F = Output diode forward voltage = ~0.3V

Example:

$$N_{PS} < \frac{65V - 32V - 15V}{5V + 0.3V} = 3.4$$

The choice of transformer turns ratio is critical in determining output current capability of the converter. Table 1 shows the switch voltage stress and output current capability at different transformer turns ratio.

Table 1. Switch Voltage Stress and Output Current Capability vs Turns Ratio

N_{PS}	$V_{SW(MAX)}$ at $V_{IN(MAX)}$ (V)	$I_{OUT(MAX)}$ at $V_{IN(MIN)}$ (mA)	DUTY CYCLE (%)
1:1	37.3	330	14-40
2:1	42.6	470	25-57
3:1	47.9	540	33-67

Since only $N_{PS} = 3$ can meet the 500mA output current requirement, $N_{PS} = 3$ is chosen in this example.

Step 2: Determine the Primary Inductance.

Primary inductance for the transformer must be set above a minimum value to satisfy the minimum switch-off and switch-on time requirements:

$$L_{PRI} \geq \frac{t_{OFF(MIN)} \cdot N_{PS} \cdot (V_{OUT} + V_F)}{I_{SW(MIN)}}$$

$$L_{PRI} \geq \frac{t_{ON(MIN)} \cdot V_{IN(MAX)}}{I_{SW(MIN)}}$$

$$t_{OFF(MIN)} = 450ns$$

$$t_{ON(MIN)} = 170ns$$

$$I_{SW(MIN)} = 290mA \text{ (typ)}$$

Example:

$$L_{PRI} \geq \frac{450ns \cdot 3 \cdot (5V + 0.3V)}{290mA} = 25\mu H$$

$$L_{PRI} \geq \frac{170ns \cdot 32V}{290mA} = 19\mu H$$

APPLICATIONS INFORMATION

Most transformers specify primary inductance with a tolerance of $\pm 20\%$. With other component tolerance considered, choose a transformer with its primary inductance 30% larger than the minimum values calculated above. $L_{PRI} = 40\mu\text{H}$ is then chosen in this example.

Once the primary inductance has been determined, the maximum load switching frequency can be calculated as:

$$f_{SW} = \frac{1}{t_{ON} + t_{OFF}} = \frac{1}{\frac{L_{PRI} \cdot I_{SW}}{V_{IN}} + \frac{L_{PRI} \cdot I_{SW}}{N_{PS} \cdot (V_{OUT} + V_F)}}$$

$$I_{SW} = \frac{V_{OUT} \cdot I_{OUT} \cdot 2}{\eta \cdot V_{IN} \cdot D}$$

Example:

$$D = \frac{(5V + 0.3V) \cdot 3}{(5V + 0.3V) \cdot 3 + 12V} = 0.57$$

$$I_{SW} = \frac{5V \cdot 0.5A \cdot 2}{0.85 \cdot 12V \cdot 0.57} = 0.86A$$

$$f_{SW} = 199\text{kHz}$$

The transformer also needs to be rated for the correct saturation current level across line and load conditions. A saturation current rating larger than 2A is necessary to work with the LT3001. The 750313974 from Würth is chosen as the flyback transformer.

Step 3: Choose the Output Diode.

Two main criteria for choosing the output diode include forward current rating and reverse voltage rating. The maximum load requirement is a good first-order guess as the average current requirement for the output diode. A conservative metric is the maximum switch current limit multiplied by the turns ratio,

$$I_{DIODE(MAX)} = I_{SW(MAX)} \cdot N_{PS}$$

Example:

$$I_{DIODE(MAX)} = 4.125A$$

Next calculate reverse voltage requirement using maximum V_{IN} :

$$V_{REVERSE} = V_{OUT} + \frac{V_{IN(MAX)}}{N_{PS}}$$

Example:

$$V_{REVERSE} = 5V + \frac{32V}{3} = 15.6V$$

The CSMH5-20 (5A, 20V diode) from Central Semiconductor is chosen.

Step 4: Choose the Output Capacitor.

The output capacitor should be chosen to minimize the output voltage ripple while considering the increase in size and cost of a larger capacitor. Use the equation below to calculate the output capacitance:

$$C_{OUT} = \frac{L_{PRI} \cdot I_{SW}^2}{2 \cdot V_{OUT} \cdot \Delta V_{OUT}}$$

Example:

Design for output voltage ripple less than 1% of V_{OUT} , i.e., 50mV.

$$C_{OUT} = \frac{40\mu\text{H} \cdot (0.86A)^2}{2 \cdot 5V \cdot 0.05V} = 60\mu\text{F}$$

Remember ceramic capacitors lose capacitance with applied voltage. The capacitance can drop to 40% of quoted capacitance at the maximum voltage rating. So a 100 μF , 10V rating ceramic capacitor is chosen.

Step 5: Design Snubber Circuit.

The snubber circuit protects the power switch from leakage inductance voltage spike. A DZ snubber is recommended for this application because of lower leakage inductance and larger voltage margin. The Zener and the diode need to be selected.

The maximum Zener breakdown voltage is set according to the maximum V_{IN} :

$$V_{ZENER(MAX)} \leq 65V - V_{IN(MAX)}$$

APPLICATIONS INFORMATION

Example:

$$V_{ZENER(MAX)} \leq 65V - 32V = 33V$$

A 20V Zener with a maximum of 21V will provide optimal protection and minimize power loss. So a 20V, 0.25W Zener from Central Semiconductor (CMDZ5250B) is chosen.

Choose a diode that is fast and has sufficient reverse voltage breakdown:

$$V_{REVERSE} > V_{SW(MAX)}$$

$$V_{SW(MAX)} = V_{IN(MAX)} + V_{ZENER(MAX)}$$

Example:

$$V_{REVERSE} > 53V$$

A 100V, 0.25A diode from Central Semiconductor (CMHD4448) is chosen.

Step 6: Select the R_{FB} Resistor.

Use the following equation to calculate the starting value for R_{FB}:

$$R_{FB} = \frac{N_{PS} \cdot (V_{OUT} + V_F)}{100\mu A}$$

Example:

$$R_{FB} = \frac{3 \cdot (5V + 0.3V)}{100\mu A} = 159k$$

Depending on the tolerance of standard resistor values, the precise resistor value may not exist. For 1% standard values, a 158k resistor should be close enough. The final R_{FB} value should be adjusted on the measured output voltage.

Step 7: Select the EN/UVLO Resistors.

Determine the amount of hysteresis required and calculate R1 resistor value:

$$V_{IN(HYS)} = 2.5\mu A \cdot R1$$

Example:

Choose 2V of hysteresis,

$$R1 = 806k$$

Determine the UVLO thresholds and calculate R2 resistor value:

$$V_{IN(UVLO+)} = \frac{1.242V \cdot (R1 + R2)}{R2} + 2.5\mu A \cdot R1$$

Example:

Set V_{IN} UVLO rising threshold to 7.5V,

$$R2 = 232k$$

$$V_{IN(UVLO+)} = 7.5V$$

$$V_{IN(UVLO-)} = 5.5V$$

Step 8: Ensure minimum load.

The theoretical minimum load can be approximately estimated as:

$$I_{LOAD(MIN)} = \frac{40\mu H \cdot (360mA)^2 \cdot 10.6kHz}{2 \cdot 5V} = 5.5mA$$

Remember to check the minimum load requirement in real application. The minimum load occurs at the point where the output voltage begins to climb up as the converter delivers more energy than what is consumed at the output. The real minimum load for this application is about 6mA. In this example, a 820Ω resistor is selected as the minimum load.

PACKAGE DESCRIPTION

S5 Package
5-Lead Plastic TSOT-23
 (Reference LTC DWG # 05-08-1635 Rev B)

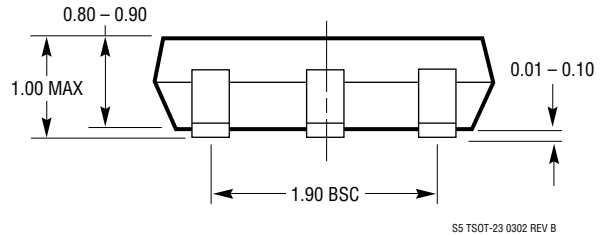
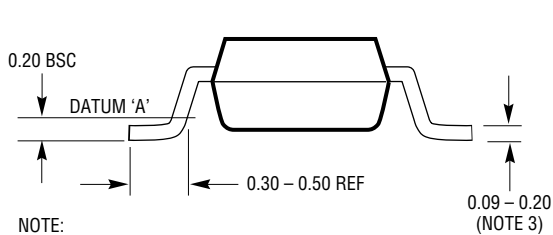
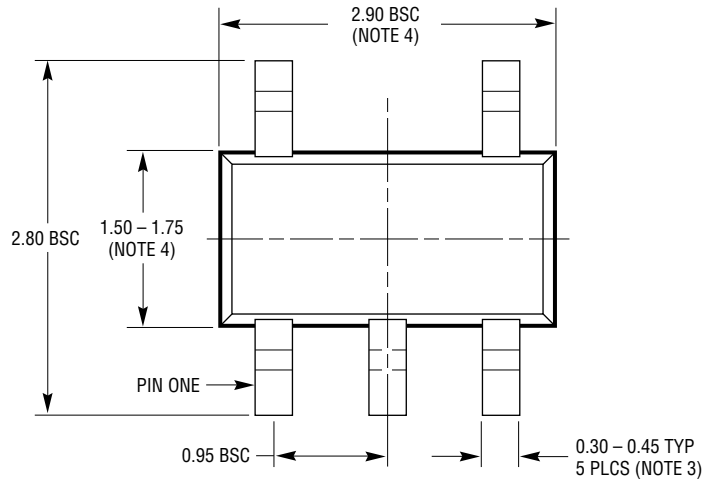
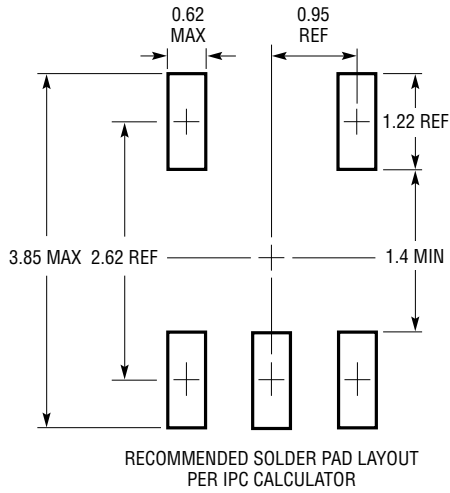

- NOTE:
 1. DIMENSIONS ARE IN MILLIMETERS
 2. DRAWING NOT TO SCALE
 3. DIMENSIONS ARE INCLUSIVE OF PLATING
 4. DIMENSIONS ARE EXCLUSIVE OF MOLD FLASH AND METAL BURR
 5. MOLD FLASH SHALL NOT EXCEED 0.254mm
 6. JEDEC PACKAGE REFERENCE IS MO-193

S5 TSOT-23 0302 REV B