



## Delta 2A

Quad Band GSM, 3G & ISM Stubby Antenna

### Key Features

- Small size
- Quad band GSM and 3G
- ISM: 868 and 915MHz
- Groundplane independent



### General Description

The Delta 2A Multiband antenna combines good performance with a small size, enabling its use with many of today's GSM / GPRS, 3G and ISM products.

The omni directional, radiating element is over moulded in black high-grade rubber, which allows flexibility and provides a rugged stylish finish.

Terminated with an SMA male or SMA RP right angle connector, it is suited to applications like Point of Sale terminals, metering or alarm panel equipment.

### Additional Considerations

- Suitable for GSM / GPRS and 3G terminal equipment
- Meets all EU compliance criteria for electronic goods





## Delta 2A

Quad Band GSM, 3G & ISM Stubby Antenna

### Electrical Specifications

Operating Temperature range:	-20 - +60°C
Storage Temperature range:	-30 - +75°C
Impedance:	50 Ohm
VSWR:	2.0
Gain:	2.0 dBi
Operating Frequencies:	GSM: 800, 900, 1800, 1900MHz 3G: 2100MHz ISM: 868, 915MHz
Radiation:	Omni Directional
Polarization:	Vertical

### Mechanical Specifications

Dimensions:	L53.5mm
Connector:	Right angle SMA male, SMA RP
Mounting Method:	Direct connect
Connector plating:	Gold/Nickel

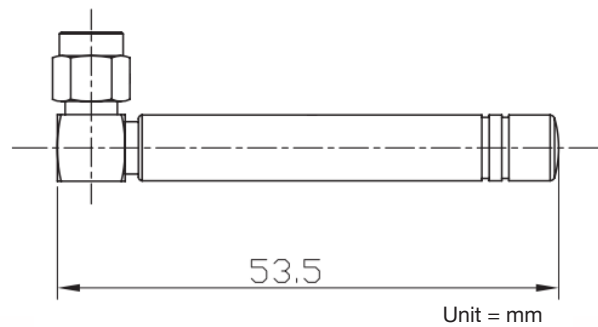

### Return Loss

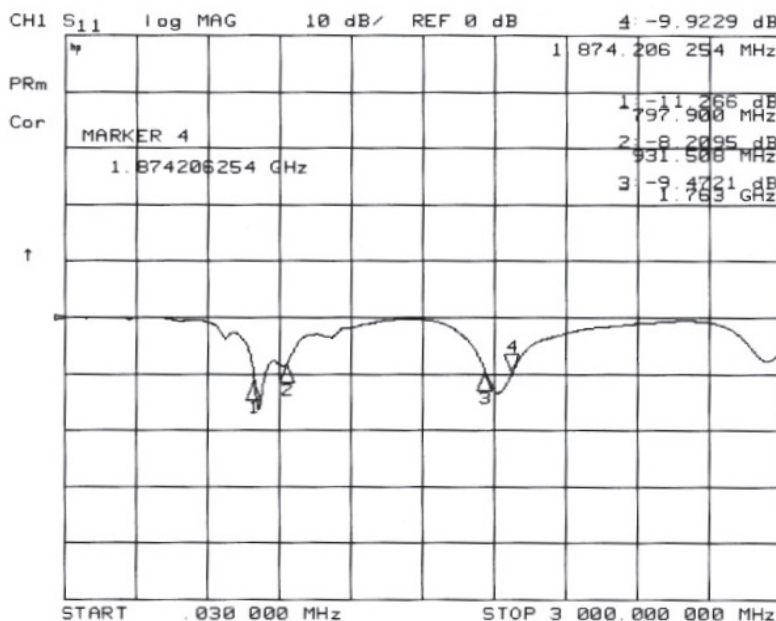

### VSWR

Frequency	dB
797.9 MHz	1.752
931.5 MHz	2.271
1763 MHz	2.012
1874 MHz	1.937



## Delta 2A

Quad Band GSM, 3G & ISM Stubby Antenna

### Radiation Plots

#### 836.5MHz

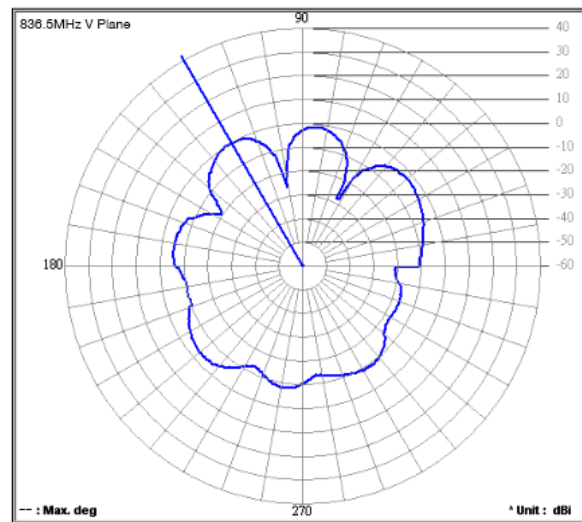
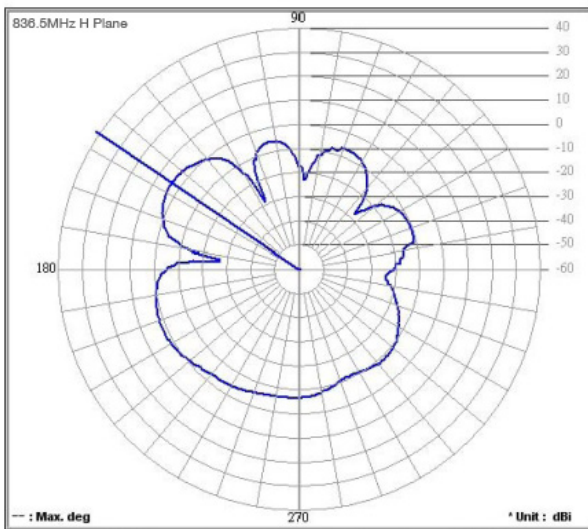

#### 897.4 MHz

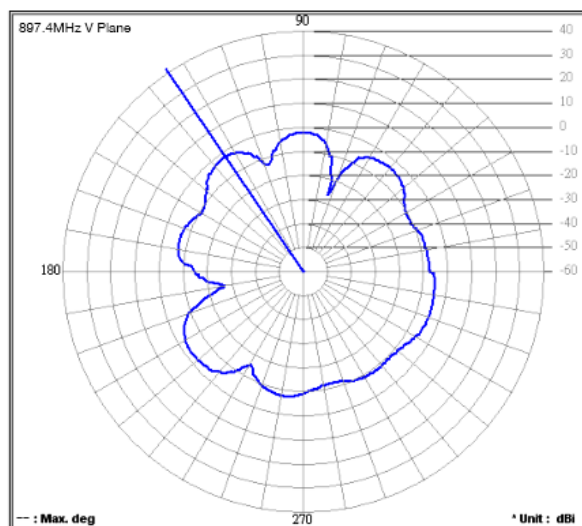
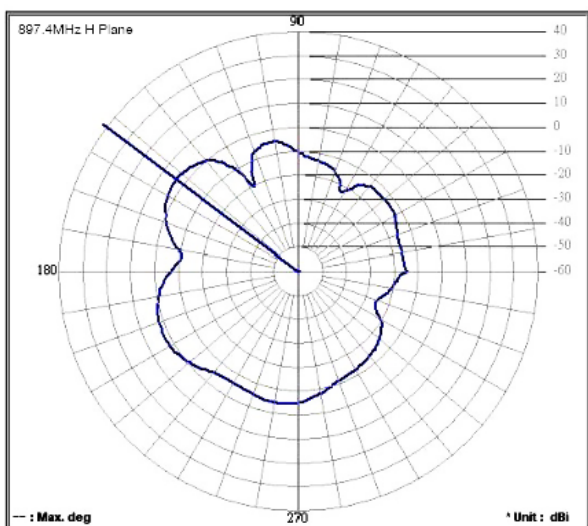



## Delta 2A

Quad Band GSM, 3G & ISM Stubby Antenna

### 1747.4 MHz

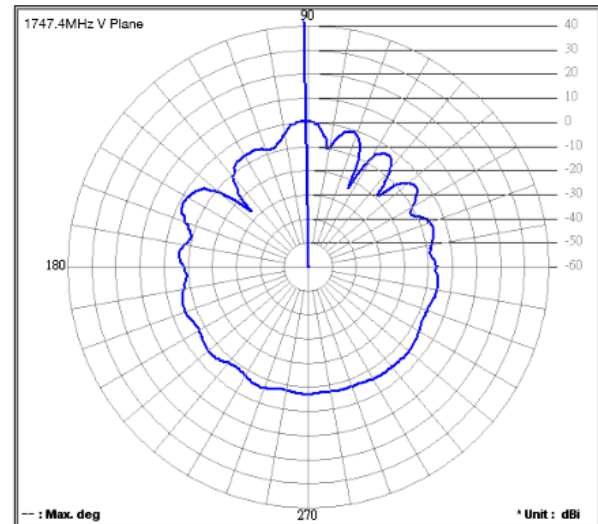
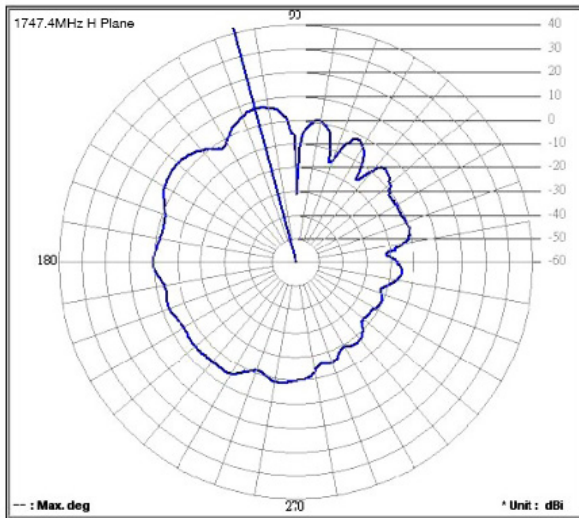

### 1868 MHz

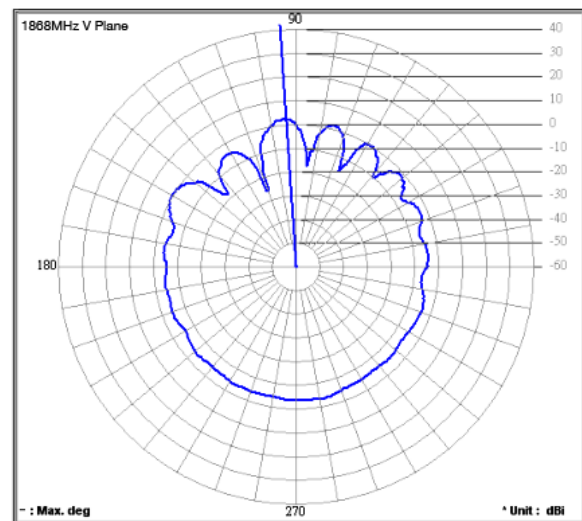
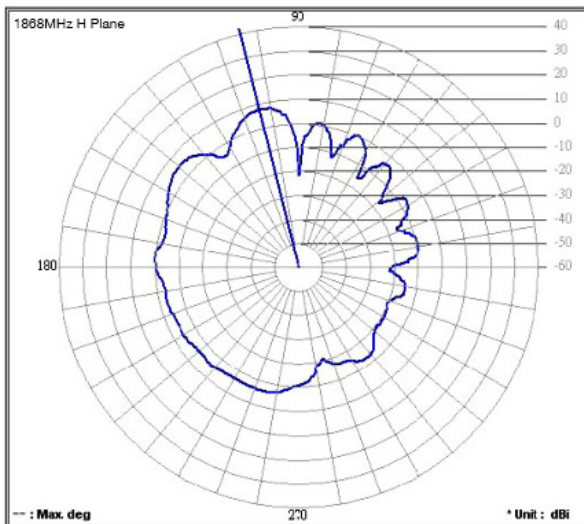

## Ordering Details

Part number

Description

DELTA2A/X/SMAM/S/RA/11

Quad Band GSM/GPRS 3G & ISM Antenna SMA Male Right Angle