

# NCP3125

## 4 A Synchronous PWM Switching Converter

The NCP3125 is a flexible synchronous PWM Switching Buck Regulator. The NCP3125 is capable of producing output voltages as low as 0.8 V. The NCP3125 also incorporates voltage mode control. To reduce the number of external components, a number of features are internally set including switching frequency. The NCP3125 is currently available in an SOIC-8 package.

### Features

- 4.5 V to 13.2 V Operating Input Voltage Range
- 60 mΩ High-Side, 36 mΩ Low-Side Switches
- Output Voltage Adjustable to 0.8 V
- 4 A Continuous Output Current
- Fixed 350 kHz PWM Operation
- 1.0% Initial Output Accuracy
- 75% Max Duty Ratio
- Over-Load Protection
- Programmable Current Limit
- This is a Pb-Free Device

### Typical Application

- Set Top Boxes
- DVD Drives and HDD
- LCD Monitors and TVs
- Cable Modems
- Telecom / Networking / Datacom Equipment

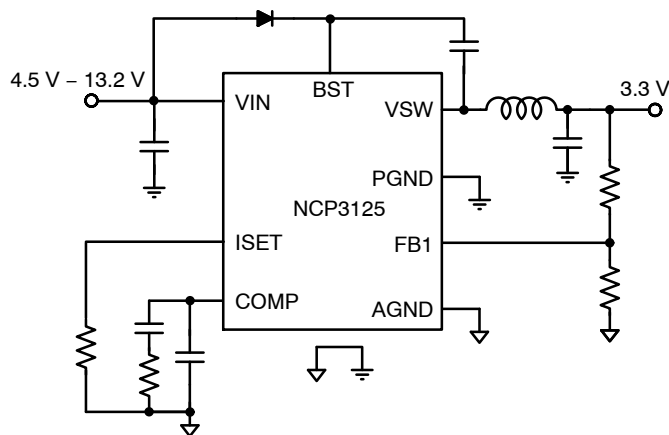

Figure 1. Typical Application Circuit

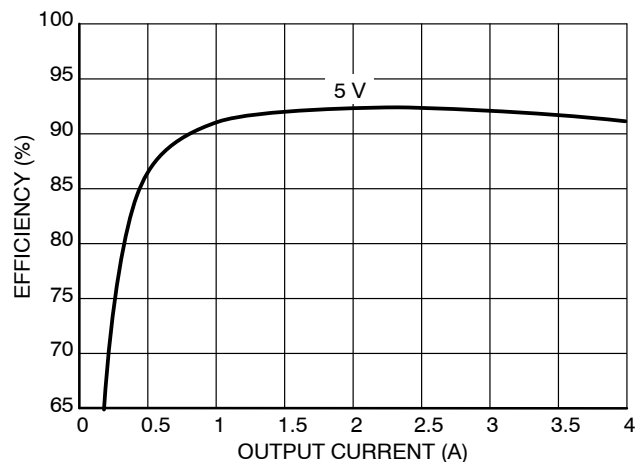
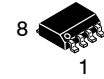

Figure 2. Efficiency ( $V_{IN} = 12 V$ ) vs. Load Current



ON Semiconductor®

<http://onsemi.com>



SOIC-8 NB  
D SUFFIX  
CASE 751

### MARKING DIAGRAM

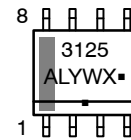

3125 = Specific Device Code  
A = Assembly Location  
L = Wafer Lot  
Y = Year/  
W = Work Week  
▪ = Pb-Free Package

### PIN CONNECTIONS

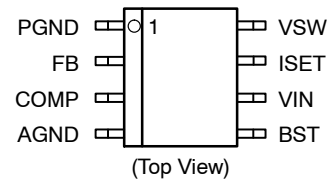

### ORDERING INFORMATION

See detailed ordering and shipping information in the package dimensions section on page 21 of this data sheet.



# NCP3125

**Table 2. MAXIMUM RATINGS**

Rating	Symbol	Min	Max	Unit
Main Supply Voltage Input	$V_{IN}$	-0.3	15	V
Bootstrap Supply Voltage vs GND	VBST	-0.3	15	V
Bootstrap Supply Voltage vs Ground (spikes $\leq$ 50 ns)	VBST spike	-5.0	35	V
Bootstrap Pin Voltage vs $V_{SW}$	$VBST - V_{SW}$	-0.3	15	V
High Side Switch Max DC Current	$I_{V_{SW}}$	0	4	A
$V_{SW}$ Pin Voltage	$V_{SW}$	-0.3	30	V
Switching Node Voltage Excursion (200 $\mu$ A)	$V_{SWLIM}$	-2.0	35	V
Switch Pin voltage (spikes < 50 ns)	$V_{SWtr}$	-5.0	40	V
FB Pin Voltage	VFB	-0.3	$5.5 < V_{CC}$	V
COMP/DISABLE	VCOMP/DIS	-0.3	$5.5 < V_{CC}$	V
Low Side Driver Pin Voltage	VISET	-0.3	$15 < V_{CC}$	V
Low Side Driver Pin Voltage (spikes $\leq$ 200 ns)	VISET Spike	-2	$15 < V_{CC}$	V
Rating	Symbol	Rating		Unit
Thermal Resistance, Junction-to-Ambient (Note 2) (Note 3)	$R_{\theta JA}$	110 183		$^{\circ}$ C/W
Thermal Resistance, Junction-to-Case	$R_{\theta JC}$	170		$^{\circ}$ C/W
Storage Temperature Range	$T_{stg}$	-55 to 150		$^{\circ}$ C
Junction Operating Temperature	$T_J$	-40 to 125		$^{\circ}$ C
Lead Temperature Soldering (10 sec): Reflow (SMD styles only) Pb-Free	RF	260 peak		$^{\circ}$ C

Stresses exceeding Maximum Ratings may damage the device. Maximum Ratings are stress ratings only. Functional operation above the Recommended Operating Conditions is not implied. Extended exposure to stresses above the Recommended Operating Conditions may affect device reliability.

1. The maximum package power dissipation limit must not be exceeded.
2. The value of  $\theta_{JA}$  is measured with the device mounted on 1 in<sup>2</sup> FR-4 board with 1 oz. copper, in a still air environment with  $T_A = 25^{\circ}$ C. The value in any given application depends on the user's specific board design.
3. The value of  $\theta_{JA}$  is measured with the device mounted on minimum footprint, in a still air environment with  $T_A = 25^{\circ}$ C. The value in any given application depends on the user's specific board design.
4. 60–180 seconds minimum above 237 $^{\circ}$ C.

# NCP3125

**Table 3. ELECTRICAL CHARACTERISTICS** ( $-40^{\circ}\text{C} < T_J < 125^{\circ}\text{C}$ ;  $V_{IN} = 12\text{ V}$ ,  $BST-V_{SW} = 12\text{ V}$ ,  $BST = 12\text{ V}$ ,  $V_{SW} = 24\text{ V}$ , for min/max values unless otherwise noted.)

Characteristic	Conditions	Min	Typ	Max	Unit
Input Voltage Range	$V_{IN} - \text{GND}$	4.5		13.2	V
Boost Voltage Range	$V_{BST} - \text{GND}$	4.5		26.5	V

## SUPPLY CURRENT

Quiescent Supply Current	$V_{FB} = 1.0\text{ V}$ , No Switching, $V_{IN} = 13.2\text{ V}$	1.0	–	10.0	mA
Shutdown Supply Current	$V_{FB} = 1.0\text{ V}$ , $\text{COMP} = 0\text{ V}$ , $V_{IN} = 13.2\text{ V}$	–	4.0	–	mA
Boost Quiescent Current	$V_{FB} = 1.0\text{ V}$ , No Switching, $V_{IN} = 13.2\text{ V}$	0.1	–	1.0	mA

## UNDER VOLTAGE LOCKOUT

$V_{IN}$ UVLO Threshold	$V_{IN}$ Rising Edge	3.8	–	4.3	V
$V_{IN}$ UVLO Hysteresis	–	–	430	–	mV

## SWITCHING REGULATOR

VFB Feedback Voltage, Control Loop in Regulation	$T_J = 0\text{ to }25^{\circ}\text{C}$ , $4.5\text{ V} < V_{CC} < 13.2\text{ V}$ $-40^{\circ}\text{C} \leq T_J \leq 125^{\circ}\text{C}$ , $4.5 \leq V_{CC} \leq 13.2\text{ V}$	792 784	800 800	808 816	mV
Oscillator Frequency	$T_J = 0\text{ to }25^{\circ}\text{C}$ , $4.5\text{ V} < V_{CC} < 13.2\text{ V}$ $-40^{\circ}\text{C} \leq T_J \leq 125^{\circ}\text{C}$ , $4.5 \leq V_{CC} \leq 13.2\text{ V}$	300 290	350 350	400 410	kHz
Ramp-Amplitude Voltage		0.8	1.1	1.4	V
Minimum Duty Ratio		–	5.5	–	%
Maximum Duty Ratio		70	75	80	%

## PWM COMPENSATION

Transconductance		3.0	–	5	mS
Open Loop DC Gain	$C_O = 1\text{ nF}$	55	70	–	dB
Output Source Current Output Sink Current	$V_{FB} < 0.8\text{ V}$ $V_{FB} > 0.8\text{ V}$	60 60	125 125	200 200	$\mu\text{A}$
Input Bias Current		–	0.160	1.0	$\mu\text{A}$

## ENABLE

Enable Threshold		0.3	0.4	0.5	V
------------------	--	-----	-----	-----	---

## SOFT-START

Delay to Soft-Start		3	–	15	ms
SS Source Current	$V_{FB} < 0.8\text{ V}$	–	10.5	–	$\mu\text{A}$
Switch Over Threshold	$V_{FB} = 0.8\text{ V}$	–	100	–	% of $V_{ref}$

## OVER-CURRENT PROTECTION

OCSET Current Source	Sourced from ISET pin, before SS	–	10	–	$\mu\text{A}$
OC Switch-Over Threshold		–	700	–	mV
Fixed OC Threshold		–	375		mV

## PWM OUTPUT STAGE

High-Side Switch On-Resistance	$V_{IN} = 12\text{ V}$ (Note 5) $V_{IN} = 5\text{ V}$ (Note 5)		60 80	75 100	$\text{m}\Omega$
Low-Side Switch On-Resistance	$V_{IN} = 12\text{ V}$ (Note 5) $V_{IN} = 5\text{ V}$ (Note 5)		36 45	40 50	$\text{m}\Omega$

5. Guaranteed by design.

TYPICAL CHARACTERISTICS

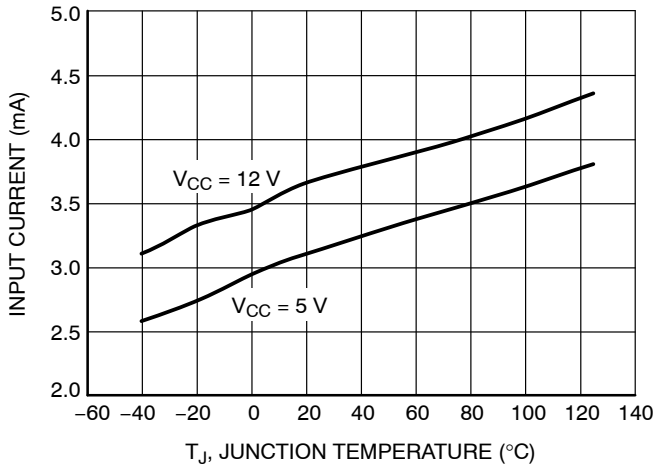

Figure 4. I<sub>CC</sub> vs. Temperature

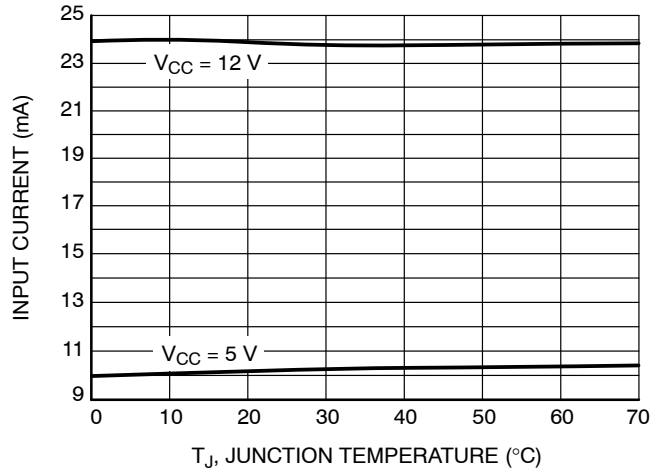

Figure 5. Input Current Switching vs. Temperature

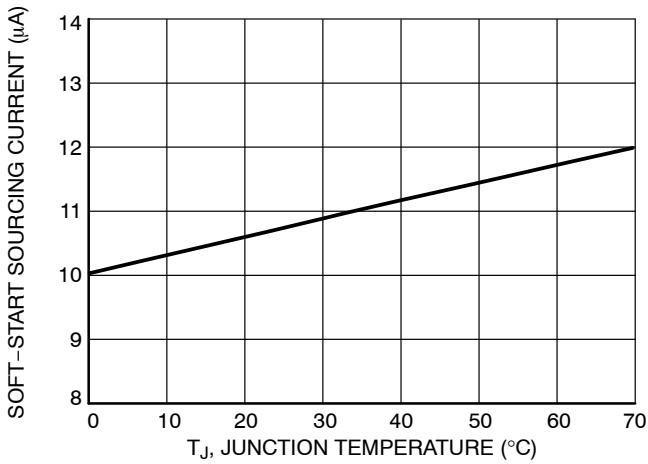

Figure 6. Soft-Start Sourcing Current vs. Temperature

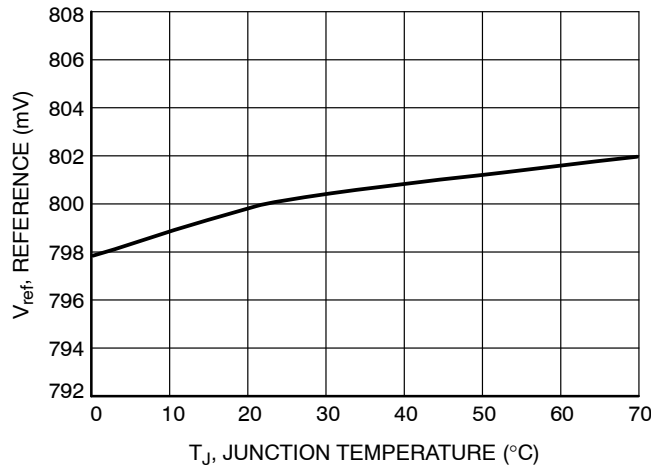

Figure 7. Reference Voltage (V<sub>ref</sub>) vs. Temperature

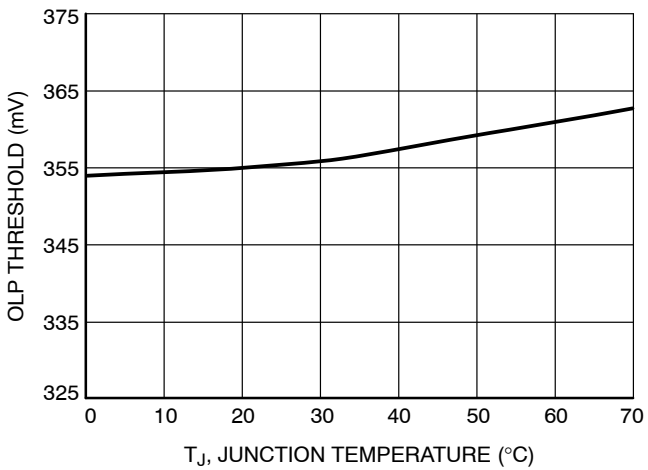

Figure 8. OLP Threshold vs. Temperature

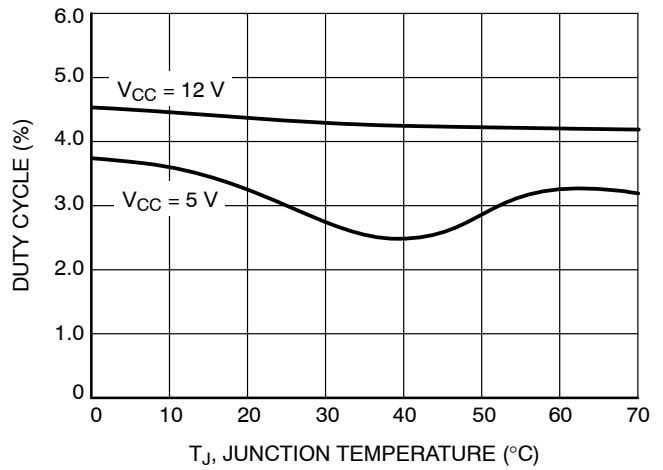

Figure 9. Minimum Active Duty Cycle vs. Temperature

# NCP3125

## TYPICAL CHARACTERISTICS

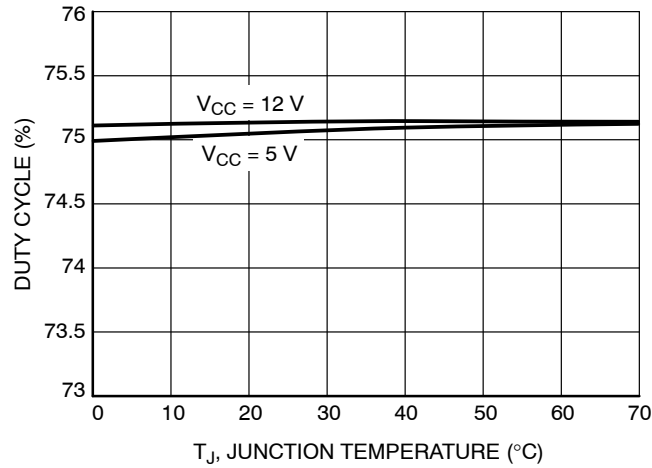

Figure 10. Duty Cycle Maximum vs. Temperature

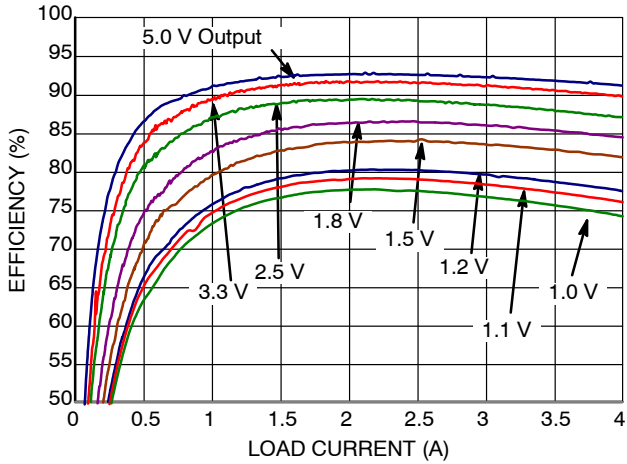

Figure 11. Efficiency ( $V_{IN} = 12\text{ V}$ ) vs. Load Current

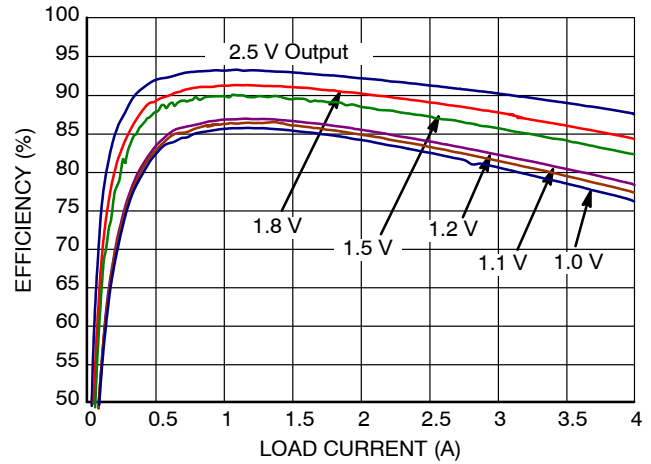

Figure 12. Efficiency ( $V_{IN} = 5\text{ V}$ ) vs. Load Current

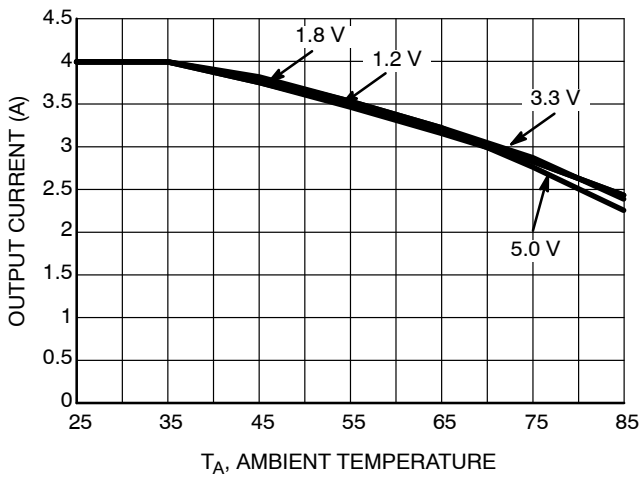

Figure 13. Derating Curve 5 V/6 V Input

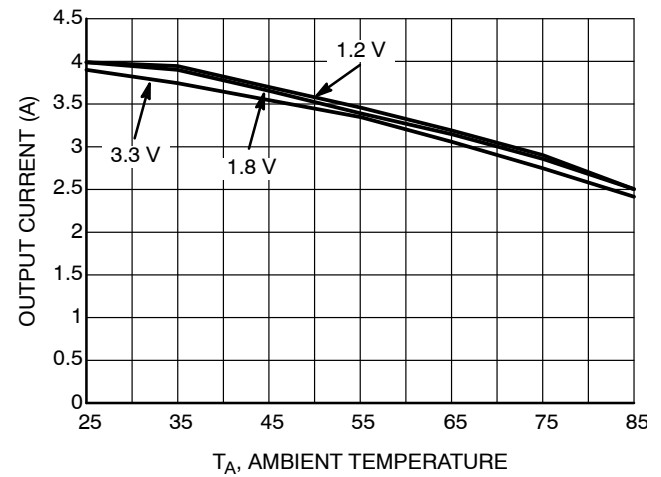

Figure 14. Derating Curve 12 V Input

**General**

The NCP3125 is a PWM synchronous buck regulator intended to supply up to a 4 A load for DC–DC conversion from 5 V and 12 V buses. The NCP3125 is a regulator that has integrated high–side and low–side NMOSFETs switches. The output voltage of the converter can be precisely regulated down to 800 mV  $\pm$ 1.0% when the VFB pin is tied to V<sub>OUT</sub>. The switching frequency is internally set to 350 kHz. A high gain operational transconductance amplifier (OTA) is used for voltage mode control of the power stage.

**Duty Ratio and Maximum Pulse Width Limits**

In steady state DC operation, the duty ratio will stabilize at an operating point defined by the ratio of the input to the output voltage. The device can achieve a 75% duty ratio. The NCP3125 has a preset off–time of approximately 150 ns, which ensures that the bootstrap supply is charged every switching cycle. The preset off time does not interfere with the conversion of 12 V to 0.8 V.

**Input Voltage Range (V<sub>IN</sub> and BST)**

The input voltage range for both V<sub>IN</sub> and BST is 4.5 V to 13.2 V with respect to GND and V<sub>SW</sub>. Although BST is rated at 13.2 V with respect to V<sub>SW</sub>, it can also tolerate 26.5 V with respect to GND.

**External Enable/Disable**

Once the input voltage has exceeded the boost and UVLO threshold at 3 V and V<sub>IN</sub> threshold at 4 V, the COMP pin starts to rise. The V<sub>SW</sub> node is tri–stated until the COMP voltage exceeds 0.9 V. Once the 0.9 V threshold is exceeded, the part starts to switch and the part is considered enabled. When the COMP pin voltage is pulled below the 400 mV threshold, it disables the PWM logic, the top MOSFET is driven off, and the bottom MOSFET is driven on. In the disabled mode, the OTA output source current is reduced to 10  $\mu$ A.

When disabling the NCP3125 using the COMP / Disable pin, an open collector or open drain drive should be used as shown in Figure 15:

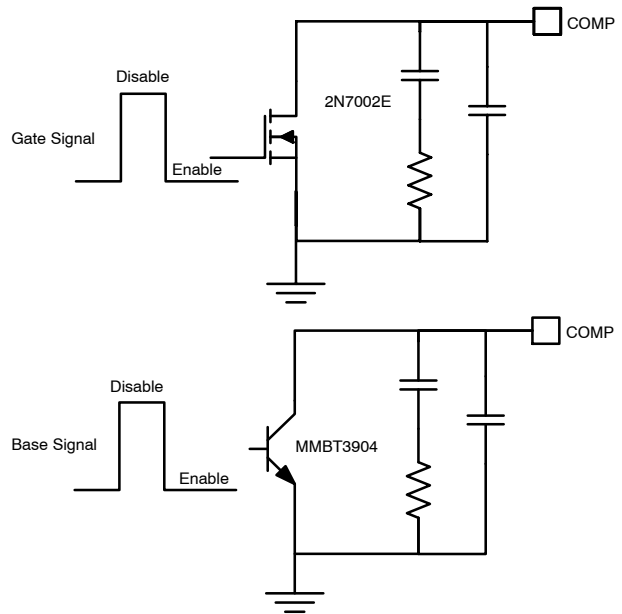

Figure 15. Recommended Disable Circuits

**Power Sequencing**

Power sequencing can be achieved with NCP3125 using two general purpose bipolar junction transistors or MOSFETs. An example of the power sequencing circuit using the external components is shown in Figure 16.

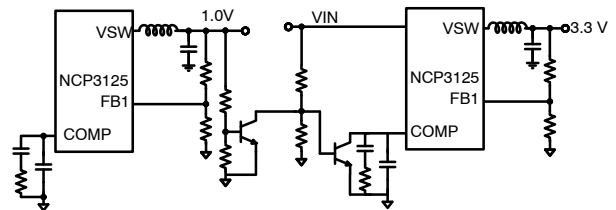

Figure 16. Power Sequencing

**Input Voltage Shutdown Behavior**

Input voltage shutdown occurs when the IC stops switching because the input supply reaches UVLO threshold. Undervoltage Lockout (UVLO) is provided to ensure that unexpected behavior does not occur when VCC is too low to support the internal rails and power the converter. The UVLO is set to permit operation when converting from an input voltage of 5 V. If the UVLO is tripped, switching stops, the internal SS is discharged, and all MOSFET gates are driven low. The V<sub>SW</sub> node enters a high impedance state and the output capacitors discharge through the load with no ringing on the output voltage.

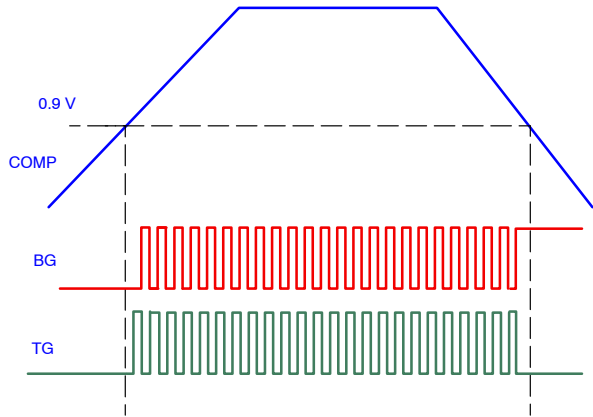

Figure 17. Enable/Disable Driver State Diagram

**External Soft-Start**

The NCP3125 features an external soft-start function, which reduces inrush current and overshoot of the output voltage. Soft-start is achieved by using the internal current source of 10.5 μA (typ), which charges the external integrator capacitor of the OTA. Figure 18 is a typical soft-start sequence. The sequence begins once V<sub>IN</sub> and V<sub>BST</sub> surpass their UVLO thresholds and OCP programming is complete. The current sourced out of the COMP pin continually increases the voltage until regulation is reached. Once the voltage reaches 400 mV logic is enabled. When the voltage exceeds 900 mV, switching begins. Current is sourced out of the COMP pin, placing the regulator into open loop operation until 800 mV is sensed at the FB pin. Once 800 mV is sensed at the FB pin, open loop operation ends and closed loop operation begins. In closed loop operation, the OTA is capable of sourcing and sinking 120 μA.

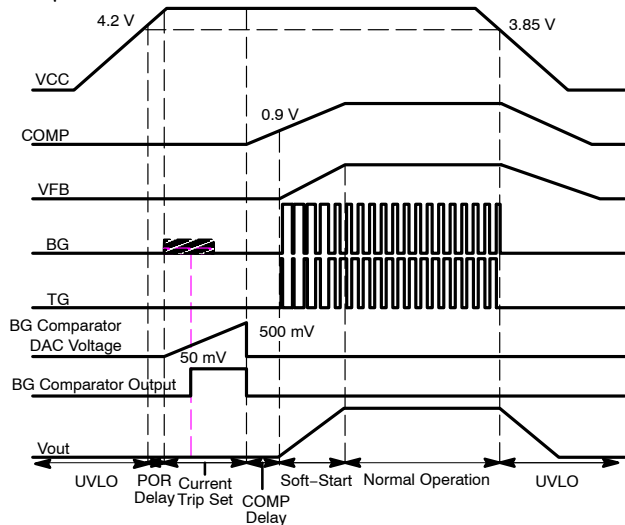

Figure 18. Soft-Start Sequence

**Overcurrent Threshold Setting**

NCP3125 overcurrent threshold can be set from 50 mV to 550 mV, by adding a resistor (R<sub>SET</sub>) between ISET and GND. During a short period of time following V<sub>IN</sub> rising over UVLO threshold, an internal 10 μA current (I<sub>OCSET</sub>) is sourced from the ISET pin, creating a voltage drop across R<sub>SET</sub>. The voltage drop is compared against a stepped internal voltage ramp. Once the internal stepped voltage reaches the R<sub>SET</sub> voltage, the value is stored internally until power is cycled. The overall time length for the OC setting procedure is approximately 9 ms. Connecting an R<sub>SET</sub> resistor between ISET and GND, the programmed threshold will be:

$$I_{OCth} = \frac{I_{OCSET} * R_{SET}}{R_{DS(on)}} \rightarrow 4.2 A = \frac{10 \mu A * 21 k\Omega}{50 m\Omega} \quad (eq. 1)$$

I<sub>OCSET</sub> = Sourced current

I<sub>OCth</sub> = Current trip threshold

R<sub>DS(on)</sub> = On resistance of the low side MOSFET

R<sub>SET</sub> = Current set resistor

The R<sub>SET</sub> values range from 5 kΩ to 55 kΩ. If R<sub>SET</sub> is not connected, the device switches the OCP threshold to a fixed 375 mV value. An internal safety clamp on ISET is triggered as soon as ISET voltage reaches 700 mV, enabling the 375 mV fixed threshold and ending the OCP setting period. The current trip threshold tolerance is ±25 mV. The accuracy is best at the highest set point (550 mV). The accuracy will decrease as the set point decreases. MOSFET tolerances with temperature and input voltage will vary the over current set threshold operating point. A graph of the typical current limit set thresholds at 4.5 V and 12 V is shown in Figure .

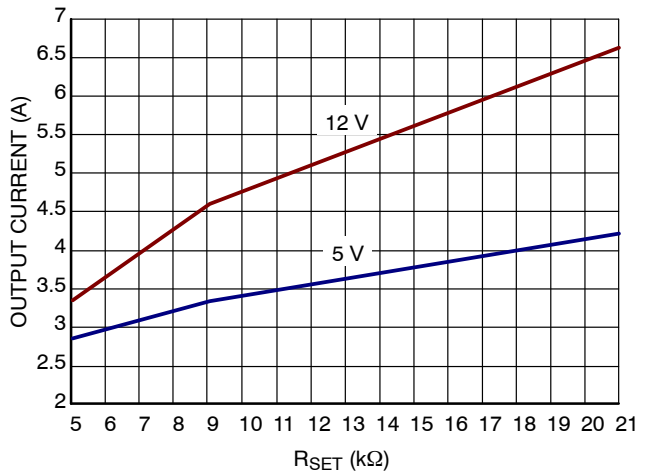

Figure 19. R<sub>SET</sub> Value for Output Current



**Current Limit Protection**

In case of an overload, the low-side (LS) FET will conduct large currents. The regulator will latch off, protecting the load and MOSFETs from excessive heat and damage. Low-side  $R_{DS(on)}$  sense is implemented at the end of each LS-FET turn-on duration to sense the current. While the low side MOSFET is on, the  $V_{SW}$  voltage is compared to the user set internally generated OCP trip voltage. If the  $V_{SW}$  voltage is lower than OCP trip voltage, an overcurrent condition occurs and a counter counts consecutive current trips. If the counter reaches 7, the PWM logic and both HS-FET and LS-FET are turned off. The regulator has to go through a Power On Reset (POR) cycle to reset the OCP fault as shown in Figure 20.

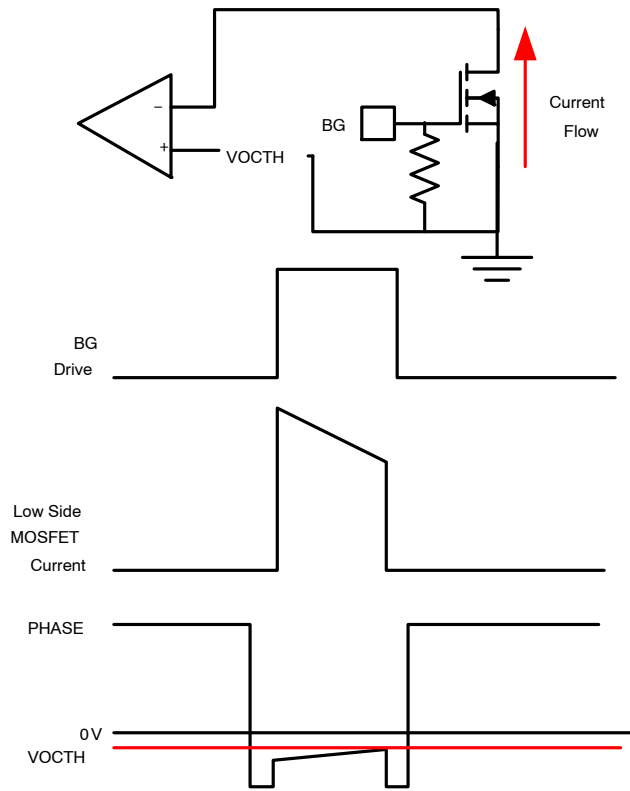

Figure 20. Current Limit Trip

**APPLICATION SECTION**

**Design Procedure**

When starting the design of a buck regulator, it is important to collect as much information as possible about the behavior of the input and output before starting the design.

ON Semiconductor has a Microsoft Excel® based design tool available online under the design tools section of the NCP3125 product page. The tool allows you to capture your design point and optimize the performance of your regulator based on your design criteria.

Table 4. DESIGN PARAMETERS

Design Parameter	Example Value
Input voltage ( $V_{IN}$ )	10.8 V to 13.2 V
Output voltage ( $V_{OUT}$ )	3.3 V
Input ripple voltage ( $V_{INRIPPLE}$ )	300 mV
Output ripple voltage ( $V_{OUTRIPPLE}$ )	60 mV
Output current rating ( $I_{OUT}$ )	4 A
Operating frequency ( $F_{SW}$ )	350 kHz

The buck converter produces input voltage  $V_{IN}$  pulses that are LC filtered to produce a lower DC output voltage  $V_{OUT}$ . The output voltage can be changed by modifying the on time relative to the switching period  $T$  or switching frequency. The ratio of high side switch on time to the switching period is called duty ratio  $D$ . Duty ratio can also be calculated using

$V_{OUT}$ ,  $V_{IN}$ , the Low Side Switch Voltage Drop  $V_{LSD}$ , and the High Side Switch Voltage Drop  $V_{HSD}$ .

$$F_{SW} = \frac{1}{T} \tag{eq. 2}$$

$$D = \frac{T_{ON}}{T} \text{ and } (1 - D) = \frac{T_{OFF}}{T} \tag{eq. 3}$$

$$D = \frac{V_{OUT} + V_{LSD}}{V_{IN} - V_{HSD} + V_{LSD}} \approx D = \frac{V_{OUT}}{V_{IN}} \rightarrow 27.5\% = \frac{3.3 \text{ V}}{12 \text{ V}} \tag{eq. 4}$$

- D = Duty cycle
- $F_{SW}$  = Switching frequency
- T = Switching period
- $T_{OFF}$  = High side switch off time
- $T_{ON}$  = High side switch on time
- $V_{HSD}$  = High side switch voltage drop
- $V_{IN}$  = Input voltage
- $V_{LSD}$  = Low side switch voltage drop
- $V_{OUT}$  = Output voltage

**Inductor Selection**

When selecting an inductor, the designer can employ a rule of thumb for the design where the percentage of ripple current in the inductor should be between 10% and 40%. When using ceramic output capacitors, the ripple current can be greater because the ESR of the output capacitor is smaller, thus a user might select a higher ripple current. However,

when using electrolytic capacitors, a lower ripple current will result in lower output ripple due to the higher ESR of electrolytic capacitors. The ratio of ripple current to maximum output current is given in Equation 5.

$$ra = \frac{\Delta I}{I_{OUT}} \quad (\text{eq. 5})$$

- $\Delta I$  = Ripple current
- $I_{OUT}$  = Output current
- $ra$  = Ripple current ratio

Using the ripple current rule of thumb, the user can establish acceptable values of inductance for a design using Equation 6.

$$L_{OUT} = \frac{V_{OUT}}{I_{OUT} \cdot ra \cdot F_{SW}} \cdot (1 - D) \rightarrow$$

$$5.7 \mu\text{H} = \frac{3.3 \text{ V}}{4 \text{ A} \cdot 30\% \cdot 350 \text{ kHz}} \cdot (1 - 27.5\%) \quad (\text{eq. 6})$$

- $D$  = Duty ratio
- $F_{SW}$  = Switching frequency
- $I_{OUT}$  = Output current
- $L_{OUT}$  = Output inductance
- $ra$  = Ripple current ratio

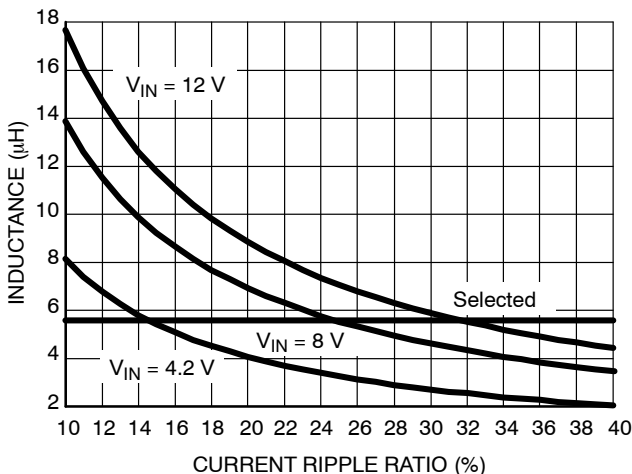

Figure 21. Inductance vs. Current Ripple Ratio

When selecting an inductor, the designer must not exceed the current rating of the part. To keep within the bounds of the part's maximum rating, a calculation of the RMS and peak inductor current is required.

$$I_{RMS} = I_{OUT} \cdot \sqrt{1 + \frac{ra^2}{12}} \rightarrow$$

$$4.01 \text{ A} = 4 \text{ A} \cdot \sqrt{1 + \frac{30\%^2}{12}} \quad (\text{eq. 7})$$

- $I_{OUT}$  = Output current
- $I_{RMS}$  = Inductor RMS current
- $ra$  = Ripple current ratio

$$I_{PK} = I_{OUT} \cdot \left(1 + \frac{ra}{2}\right) \rightarrow 4.6 \text{ A} = 4 \text{ A} \cdot \left(1 + \frac{30\%}{2}\right) \quad (\text{eq. 8})$$

- $I_{OUT}$  = Output current
- $I_{PK}$  = Inductor peak current
- $ra$  = Ripple current ratio

A standard inductor should be found so the inductor will be rounded to 5.6  $\mu\text{H}$ . The inductor should also support an RMS current of 4.01 A and a peak current of 4.6 A.

The final selection of an output inductor has both mechanical and electrical considerations. From a mechanical perspective, smaller inductor values generally correspond to smaller physical size. Since the inductor is often one of the largest components in the regulation system, a minimum inductor value is particularly important in space constrained applications. From an electrical perspective, the maximum current slew rate through the output inductor for a buck regulator is given by Equation 9.

$$\text{SlewRate}_{L_{OUT}} = \frac{V_{IN} - V_{OUT}}{L_{OUT}} \rightarrow 1.53 \frac{\text{A}}{\mu\text{s}} = \frac{12 \text{ V} - 3.3 \text{ V}}{5.6 \mu\text{H}} \quad (\text{eq. 9})$$

- $L_{OUT}$  = Output inductance
- $V_{IN}$  = Input voltage
- $V_{OUT}$  = Maximum output voltage

Equation 9 implies that larger inductor values limit the regulator's ability to slew current through the output inductor in response to output load transients. Consequently, output capacitors must supply the load current until the inductor current reaches the output load current level. Reduced inductance to increase slew rates results in larger values of output capacitance to maintain tight output voltage regulation. In contrast, smaller values of inductance increase the regulator's maximum achievable slew rate and decrease the necessary capacitance, at the expense of higher ripple current. The peak-to-peak ripple current for NCP3125 is given by the following equation:

$$I_{pp} = \frac{V_{OUT} \times (1 - D)}{L_{OUT} \cdot F_{SW}} \rightarrow$$

$$1.2 \text{ A} = \frac{3.3 \text{ V} \times (1 - 27.5\%)}{5.6 \mu\text{H} \cdot 350 \text{ kHz}} \quad (\text{eq. 10})$$

- $D$  = Duty ratio
- $F_{SW}$  = Switching frequency
- $I_{pp}$  = Peak-to-peak current of the inductor
- $L_{OUT}$  = Output inductance
- $V_{OUT}$  = Output voltage

From Equation 10 it is clear that the ripple current increases as  $L_{OUT}$  decreases, emphasizing the trade-off between dynamic response and ripple current.

The power dissipation of an inductor falls into two categories: copper and core losses. The copper losses can be further categorized into DC losses and AC losses. A good first order approximation of the inductor losses can be made using the DC resistance as shown below:

$$LP_{DC} = I_{RMS}^2 \cdot DCR \rightarrow$$

$$281 \text{ mW} = 4.01^2 \cdot 17.5 \text{ m}\Omega \quad (\text{eq. 11})$$

$I_{RMS}$  = Inductor RMS current  
 $DCR$  = Inductor DC resistance  
 $LP_{CU\_DC}$  = Inductor DC power dissipation

The core losses and AC copper losses will depend on the geometry of the selected core, core material, and wire used. Most vendors will provide the appropriate information to make accurate calculations of the power dissipation at which point the total inductor losses can be captured by the equation below:

$$LP_{tot} = LP_{CU\_DC} + LP_{CU\_AC} + LP_{Core} \rightarrow$$

$$303 \text{ mW} = 281 \text{ mW} + 1 \text{ mW} + 21 \text{ mW} \quad (\text{eq. 12})$$

$LP_{CU\_DC}$  = Inductor DC power dissipation  
 $LP_{CU\_AC}$  = Inductor AC power dissipation  
 $LP_{Core}$  = Inductor core power dissipation

### Output Capacitor Selection

The important factors to consider when selecting an output capacitor are DC voltage rating, ripple current rating, output ripple voltage requirements, and transient response requirements.

The output capacitor must be rated to handle the ripple current at full load with proper derating. The RMS ratings given in datasheets are generally for lower switching frequency than used in switch mode power supplies, but a multiplier is usually given for higher frequency operation. The RMS current for the output capacitor can be calculated below:

$$C_{O_{RMS}} = I_{OUT} \cdot \frac{ra}{\sqrt{12}} \rightarrow 0.346 \text{ A} = 4 \text{ A} \frac{30\%}{\sqrt{12}} \quad (\text{eq. 13})$$

$C_{O_{RMS}}$  = Output capacitor RMS current  
 $I_{OUT}$  = Output current  
 $ra$  = Ripple current ratio

The maximum allowable output voltage ripple is a combination of the ripple current selected, the output capacitance selected, the Equivalent Series Inductance (ESL), and Equivalent Series Resistance (ESR).

The main component of the ripple voltage is usually due to the ESR of the output capacitor and the capacitance selected, which can be calculated as shown in Equation 14:

$$V_{ESR\_C} = I_{OUT} \cdot ra \cdot \left( C_{O_{ESR}} + \frac{1}{8 \cdot F_{SW} \cdot C_{OUT}} \right) \rightarrow$$

$$60.91 \text{ mV} = 4 \cdot 30\% \cdot \left( 50 \text{ m}\Omega + \frac{1}{8 \cdot 350 \text{ kHz} \cdot 470 \text{ }\mu\text{F}} \right) \quad (\text{eq. 14})$$

$C_{O_{ESR}}$  = Output capacitor ESR  
 $C_{OUT}$  = Output capacitance  
 $F_{SW}$  = Switching frequency  
 $I_{OUT}$  = Output current  
 $ra$  = Ripple current ratio

The ESL of capacitors depends on the technology chosen, but tends to range from 1 nH to 20 nH, where ceramic capacitors have the lowest inductance and electrolytic capacitors have the highest. The calculated contributing voltage ripple from ESL is shown for the switch on and switch off below:

$$V_{ESLON} = \frac{ESL \cdot I_{pp} \cdot F_{SW}}{D} \rightarrow$$

$$15.27 \text{ mV} = \frac{10 \text{ nH} \cdot 1.2 \text{ A} \cdot 350 \text{ kHz}}{27.5\%} \quad (\text{eq. 15})$$

$$V_{ESLOFF} = \frac{ESL \cdot I_{pp} \cdot F_{SW}}{(1 - D)} \rightarrow$$

$$5.79 \text{ mV} = \frac{10 \text{ nH} \cdot 1.2 \text{ A} \cdot 350 \text{ kHz}}{(1 - 27.5\%)} \quad (\text{eq. 16})$$

$D$  = Duty ratio  
 $ESL$  = Capacitor inductance  
 $F_{SW}$  = Switching frequency  
 $I_{pp}$  = Peak-to-peak current

The output capacitor is a basic component for the fast response of the power supply. For the first few microseconds of a load transient, the output capacitor supplies current to the load. Once the regulator recognizes a load transient, it adjusts the duty ratio, but the current slope is limited by the inductor value.

During a load step transient, the output voltage initially drops due to the current variation inside the capacitor and the ESR (neglecting the effect of the ESL).

$$\Delta V_{OUT-ESR} = I_{TRAN} \times C_{O_{ESR}} \rightarrow 115 \text{ mV} = 2.3 \times 50 \text{ m}\Omega \quad (\text{eq. 17})$$

$C_{O_{ESR}}$  = Output capacitor Equivalent Series Resistance  
 $I_{TRAN}$  = Output transient current  
 $\Delta V_{OUT\_ESR}$  = Voltage deviation of  $V_{OUT}$  due to the effects of ESR

A minimum capacitor value is required to sustain the current during the load transient without discharging it. The voltage drop due to output capacitor discharge is given by the following equation:

$$\Delta V_{OUT-DIS} = \frac{(I_{TRAN})^2 \times L_{OUT}}{2 \times D_{MAX} \times C_{OUT} \times (V_{IN} - V_{OUT})} \rightarrow$$

$$4.9 \text{ mV} = \frac{(2.3 \text{ A})^2 \times 5.6 \text{ }\mu\text{H}}{2 \times 75\% \times 470 \text{ }\mu\text{F} \times (12 \text{ V} - 3.3 \text{ V})} \quad (\text{eq. 18})$$

$C_{OUT}$  = Output capacitance  
 $D_{MAX}$  = Maximum duty ratio  
 $I_{TRAN}$  = Output transient current  
 $L_{OUT}$  = Output inductor value  
 $V_{IN}$  = Input voltage  
 $V_{OUT}$  = Output voltage  
 $\Delta V_{OUT\_DIS}$  = Voltage deviation of  $V_{OUT}$  due to the effects of capacitor discharge

In a typical converter design, the ESR of the output capacitor bank dominates the transient response. Please note that  $\Delta V_{OUT-DIS}$  and  $\Delta V_{OUT-ESR}$  are out of phase with each other, and the larger of these two voltages will determine the maximum deviation of the output voltage (neglecting the effect of the ESL).

### Input Capacitor Selection

The input capacitor has to sustain the ripple current produced during the on time of the upper MOSFET, so it must have a low ESR to minimize the losses. The RMS value of the input ripple current is:

$$I_{in\_RMS} = I_{OUT} \sqrt{D \times (1 - D)} \rightarrow$$

$$1.79 \text{ A} = 4 \text{ A} \cdot \sqrt{27.5\% \cdot (1 - 27.5\%)} \quad (\text{eq. 19})$$

- D = Duty ratio
- $I_{IN\_RMS}$  = Input capacitance RMS current
- $I_{OUT}$  = Load current

The equation reaches its maximum value with  $D = 0.5$ . Loss in the input capacitors can be calculated with the following equation:

$$P_{CIN} = C_{IN\_ESR} \cdot (I_{IN\_RMS})^2 \rightarrow$$

$$32 \text{ mW} = 10 \text{ m}\Omega \cdot (1.79 \text{ A})^2 \quad (\text{eq. 20})$$

- $C_{IN\_ESR}$  = Input capacitance Equivalent Series Resistance
- $I_{IN\_RMS}$  = Input capacitance RMS current
- $P_{CIN}$  = Power loss in the input capacitor

Due to large di/dt through the input capacitors, electrolytic or ceramics should be used. If a tantalum must be used, it must be surge protected, otherwise, capacitor failure could occur.

### Power MOSFET Dissipation

MOSFET power dissipation, package size, and the thermal environment drive power supply design. Once the dissipation is known, the thermal impedance can be calculated to prevent the specified maximum junction temperatures from being exceeded at the highest ambient temperature.

Power dissipation has two primary contributors: conduction losses and switching losses. The high-side MOSFET will display both switching and conduction losses. The switching losses of the low side MOSFET will not be calculated as it switches into nearly zero voltage and the losses are insignificant. However, the body diode in the low-side MOSFET will suffer diode losses during the non-overlap time of the gate drivers.

Starting with the high-side MOSFET, the power dissipation can be approximated from:

$$P_{D\_HS} = P_{COND} + P_{SW\_TOT} \quad (\text{eq. 21})$$

- $P_{COND}$  = Conduction power losses
- $P_{SW\_TOT}$  = Total switching losses
- $P_{D\_HS}$  = Power losses in the high side MOSFET

The first term in Equation 21 is the conduction loss of the high-side MOSFET while it is on.

$$P_{COND} = (I_{RMS\_HS})^2 \cdot R_{DS(on)\_HS} \quad (\text{eq. 22})$$

- $I_{RMS\_HS}$  = RMS current in the high-side MOSFET
- $R_{DS(on)\_HS}$  = On resistance of the high-side MOSFET
- $P_{cond}$  = Conduction power losses

Using the  $ra$  term from Equation 5,  $I_{RMS}$  becomes:

$$I_{RMS\_HS} = I_{OUT} \cdot \sqrt{D \cdot \left(1 + \frac{ra^2}{12}\right)} \quad (\text{eq. 23})$$

- $I_{RMS\_HS}$  = High side MOSFET RMS current
- $I_{OUT}$  = Output current
- D = Duty ratio
- $ra$  = Ripple current ratio

The second term from Equation 21 is the total switching loss and can be approximated from the following equations.

$$P_{SW\_TOT} = P_{SW} + P_{DS} + P_{RR} \quad (\text{eq. 24})$$

- $P_{DS}$  = High side MOSFET drain source losses
- $P_{RR}$  = High side MOSFET reverse recovery losses
- $P_{SW}$  = High side MOSFET switching losses
- $P_{SW\_TOT}$  = High side MOSFET total switching losses

The first term for total switching losses from Equation 24 are the losses associated with turning the high-side MOSFET on and off and the corresponding overlap in drain voltage and current.

$$P_{SW} = P_{TON} + P_{TOFF}$$

$$= \frac{1}{2} \cdot (I_{OUT} \cdot V_{IN} \cdot F_{SW}) \cdot (t_{RISE} + t_{FALL}) \quad (\text{eq. 25})$$

- $F_{SW}$  = Switching frequency
- $I_{OUT}$  = Load current
- $t_{FALL}$  = MOSFET fall time
- $t_{RISE}$  = MOSFET rise time
- $V_{IN}$  = Input voltage
- $P_{SW}$  = High side MOSFET switching losses
- $P_{TON}$  = Turn on power losses
- $P_{TOFF}$  = Turn off power losses

When calculating the rise time and fall time of the high side MOSFET it is important to know the charge characteristic shown in Figure 22.

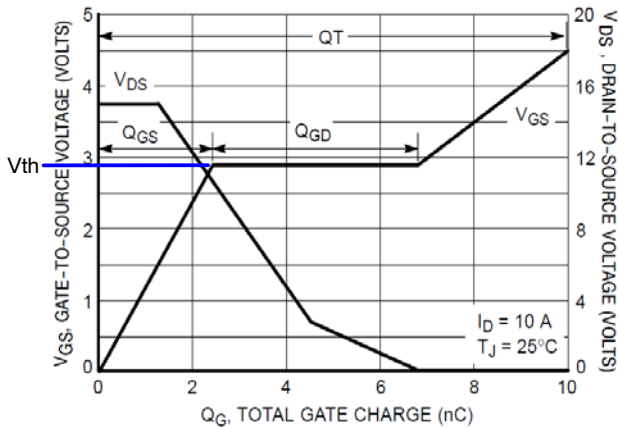

Figure 22. MOSFET Switching Characteristics

$$t_{RISE} = \frac{Q_{GD}}{I_{G1}} = \frac{Q_{GD}}{(V_{BST} - V_{TH}) / (R_{HSPU} + R_G)} \quad (\text{eq. 26})$$

- $I_{G1}$  = Output current from the high-side gate drive
- $Q_{GD}$  = MOSFET gate to drain gate charge
- $R_{HSPU}$  = Drive pull up resistance
- $R_G$  = MOSFET gate resistance
- $t_{RISE}$  = MOSFET rise time
- $V_{BST}$  = Boost voltage
- $V_{TH}$  = MOSFET gate threshold voltage

$$t_{FALL} = \frac{Q_{GD}}{I_{G2}} = \frac{Q_{GD}}{(V_{BST} - V_{TH}) / (R_{HSPD} + R_G)} \quad (\text{eq. 27})$$

- $I_{G2}$  = Output current from the low-side gate drive
- $Q_{GD}$  = MOSFET gate to drain gate charge
- $R_G$  = MOSFET gate resistance
- $R_{HSPD}$  = Drive pull down resistance
- $t_{FALL}$  = MOSFET fall time
- $V_{BST}$  = Boost voltage
- $V_{TH}$  = MOSFET gate threshold voltage

Next, the MOSFET output capacitance losses are caused by both the high-side and low-side MOSFETs, but are dissipated only in the high-side MOSFET.

$$P_{DS} = \frac{1}{2} \cdot C_{OSS} \cdot V_{IN}^2 \cdot F_{SW} \quad (\text{eq. 28})$$

- $C_{OSS}$  = MOSFET output capacitance at 0V
- $F_{SW}$  = Switching frequency
- $P_{DS}$  = MOSFET drain to source charge losses
- $V_{IN}$  = Input voltage

Finally, the loss due to the reverse recovery time of the body diode in the low-side MOSFET is shown as follows:

$$P_{RR} = Q_{RR} \cdot V_{IN} \cdot F_{SW} \quad (\text{eq. 29})$$

- $F_{SW}$  = Switching frequency
- $P_{RR}$  = High side MOSFET reverse recovery losses
- $Q_{RR}$  = Reverse recovery charge
- $V_{IN}$  = Input voltage

The low-side MOSFET turns on into small negative voltages so switching losses are negligible. The low-side MOSFET's power dissipation only consists of conduction loss due to  $R_{DS(on)}$  and body diode loss during the non-overlap periods.

$$P_{D\_LS} = P_{COND} + P_{BODY} \quad (\text{eq. 30})$$

- $P_{BODY}$  = Low side MOSFET body diode losses
- $P_{COND}$  = Low side MOSFET conduction losses
- $P_{D\_LS}$  = Low side MOSFET losses

Conduction loss in the low-side MOSFET is described as follows:

$$P_{COND} = (I_{RMS\_LS})^2 \cdot R_{DS(on)\_LS} \quad (\text{eq. 31})$$

- $I_{RMS\_LS}$  = RMS current in the low side
- $R_{DS(on)\_LS}$  = Low-side MOSFET on resistance
- $P_{COND}$  = High side MOSFET conduction losses

$$I_{RMS\_LS} = I_{OUT} \cdot \sqrt{(1 - D) \cdot \left(1 + \left(\frac{ra^2}{12}\right)\right)} \quad (\text{eq. 32})$$

- $D$  = Duty ratio
- $I_{OUT}$  = Load current
- $I_{RMS\_LS}$  = RMS current in the low side
- $ra$  = Ripple current ratio

The body diode losses can be approximated as:

$$P_{BODY} = V_{FD} \cdot I_{OUT} \cdot F_{SW} \cdot (NOL_{LH} + NOL_{HL}) \quad (\text{eq. 33})$$

- $F_{SW}$  = Switching frequency
- $I_{OUT}$  = Load current
- $NOL_{HL}$  = Dead time between the high-side MOSFET turning off and the low-side MOSFET turning on, typically 50 ns
- $NOL_{LH}$  = Dead time between the low-side MOSFET turning off and the high-side MOSFET turning on, typically 50 ns
- $P_{BODY}$  = Low-side MOSFET body diode losses
- $V_{FD}$  = Body diode forward voltage drop

### Control Dissipation

The control portion of the IC power dissipation is determined by the formula below:

$$P_C = I_{CC} \times V_{IN} \quad (\text{eq. 34})$$

- $I_{CC}$  = Control circuitry current draw
- $P_C$  = Control power dissipation
- $V_{IN}$  = Input voltage

Once the IC power dissipations are determined, the designer can calculate the required thermal impedance to maintain a specified junction temperature at the worst case

ambient temperature. The formula for calculating the junction temperature with the package in free air is:

$$T_J = T_A + P_D \cdot R_{\theta JA} \quad (\text{eq. 35})$$

- $P_D$  = Power dissipation of the IC
- $R_{\theta JA}$  = Thermal resistance junction to ambient of the regulator package
- $T_A$  = Ambient temperature
- $T_J$  = Junction temperature

As with any power design, proper laboratory testing should be performed to ensure the design will dissipate the required power under worst case operating conditions. Variables considered during testing should include maximum ambient temperature, minimum airflow, maximum input voltage, maximum loading, and component variations (i.e., worst case MOSFET  $R_{DS(on)}$ ).

**Compensation Network**

To create a stable power supply, the compensation network around the transconductance amplifier must be used in conjunction with the PWM generator and the power stage. Since the power stage design criteria is set by the application, the compensation network must correct the over all system response to ensure stability. The output inductor and capacitor of the power stage form a double pole at the frequency as shown in Equation 36:

$$F_{LC} = \frac{1}{2\pi \sqrt{L_{OUT} \times C_{OUT}}} \rightarrow \quad (\text{eq. 36})$$

$$3.102 \text{ kHz} = \frac{1}{2\pi \times \sqrt{5.6 \mu\text{H} \times 470 \mu\text{F}}}$$

- $C_{OUT}$  = Output capacitor
- $F_{LC}$  = Double pole inductor and capacitor frequency
- $L_{OUT}$  = Output inductor value

The ESR of the output capacitor creates a “zero” at the frequency as shown in Equation 37:

$$F_{ESR} = \frac{1}{2\pi \times CO_{ESR} \times C_{OUT}} \rightarrow \quad (\text{eq. 37})$$

$$6.772 \text{ kHz} = \frac{1}{2\pi \times 0.050 \text{ m}\Omega \times 470 \mu\text{F}}$$

- $CO_{ESR}$  = Output capacitor ESR
- $C_{OUT}$  = Output capacitor
- $F_{LC}$  = Output capacitor ESR frequency

The two equations above define the bode plot that the power stage has created or open loop response of the system. The next step is to close the loop by considering the feedback values. The closed loop crossover frequency should be greater than the  $F_{LC}$  and less than 1/5 of the switching frequency, which would place the maximum crossover frequency at 70 kHz. Further, the calculated  $F_{ESR}$  frequency should meet the following:

$$F_{ESR} < \frac{F_{SW}}{5} \quad (\text{eq. 38})$$

- $F_{SW}$  = Switching frequency
- $F_{ESR}$  = Output capacitor ESR zero frequency

If the criteria is not met, the compensation network may not provide stability and the output power stage must be modified.

Figure 23 shows a pseudo Type III transconductance error amplifier.

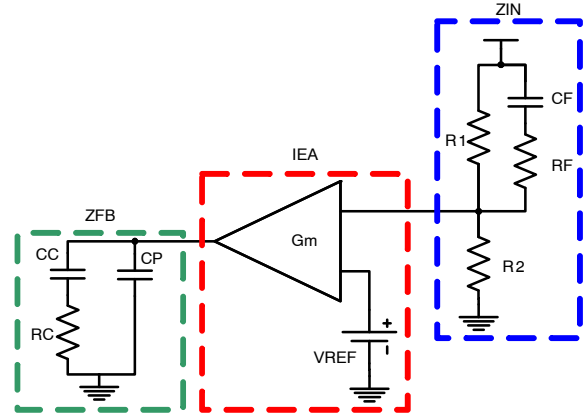

**Figure 23. Pseudo Type III Transconductance Error Amplifier**

The compensation network consists of the internal OTA and the impedance networks  $Z_{IN}$  ( $R_1$ ,  $R_2$ ,  $R_F$ , and  $C_F$ ) and external  $Z_{FB}$  ( $R_C$ ,  $C_C$ , and  $C_P$ ). The compensation network has to provide a closed loop transfer function with the highest 0 dB crossing frequency to have fast response and the highest gain in DC conditions to minimize the load regulation issues. A stable control loop has a gain crossing with  $-20$  dB/decade slope and a phase margin greater than  $45^\circ$ . Include worst-case component variations when determining phase margin. To start the design, a resistor value should be chosen for  $R_2$  from which all other components can be chosen. A good starting value is 10 k $\Omega$ .

The NCP3125 allows the output of the DC-DC regulator to be adjusted down to 0.8 V via an external resistor divider network. The regulator will maintain 0.8 V at the feedback pin. Thus, if a resistor divider circuit was placed across the feedback pin to  $V_{OUT}$ , the regulator will regulate the output voltage proportional to the resistor divider network in order to maintain 0.8 V at the FB pin.

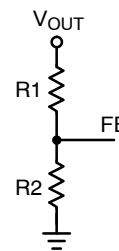

**Figure 24. Feedback Resistor Divider**

The relationship between the resistor divider network above and the output voltage is shown in Equation 39:

$$R_2 = R_1 \cdot \left( \frac{V_{REF}}{V_{OUT} - V_{REF}} \right) \quad (\text{eq. 39})$$

- R<sub>1</sub> = Top resistor divider
- R<sub>2</sub> = Bottom resistor divider
- V<sub>OUT</sub> = Output voltage
- V<sub>REF</sub> = Regulator reference voltage

The most frequently used output voltages and their associated standard R<sub>1</sub> and R<sub>2</sub> values are listed in Table 5.

**Table 5. OUTPUT VOLTAGE SETTINGS**

V <sub>O</sub> (V)	R <sub>1</sub> (kΩ)	R <sub>2</sub> (kΩ)
0.8	1.0	Open
1.2	4.99	10
1.5	10	11.5
1.8	12.7	10.2
2.5	21.5	10
3.3	31.6	10
5.0	52.3	10

The compensation components for the Pseudo Type III Transconductance Error Amplifier can be calculated using the method described below. The method serves to provide a good starting place for compensation of a power supply. The values can be adjusted in real time using the compensation tool comp calc, available for download at ON Semiconductor's website.

The value of the feed through resistor should always be at least 2X the value of R<sub>2</sub> to minimize error from feed through noise. Using the 2X assumption, R<sub>F</sub> will be set to 20 kΩ and the feed through capacitor can be calculated as shown below:

## NCP3125

$$C_F = \frac{(R_1 + R_2)}{2\pi \times (R_1 + R_F + R_2 \times R_F + R_2 \times R_1) \times f_{\text{cross}}} \quad (\text{eq. 40})$$

$$0.96 \text{ nF} = \frac{(31.6 \text{ k}\Omega + 10 \text{ k}\Omega)}{2\pi \times (31.6 \text{ k}\Omega \times 20 \text{ k}\Omega + 10 \text{ k}\Omega \times 20 \text{ k}\Omega + 10 \text{ k}\Omega \times 31.6 \text{ k}\Omega) \times 30 \text{ kHz}}$$

$C_F$  = Feed through capacitor  
 $f_{\text{cross}}$  = Crossover frequency  
 $R_1$  = Top resistor divider  
 $R_2$  = Bottom resistor divider  
 $R_F$  = Feed through resistor

The cross over of the overall feedback occurs at  $F_{PO}$ :

$$F_{PO} = \frac{(R_1 + R_F)}{(2\pi)^2 \times (C_F)^2 [(R_1 + R_F) \times R_2 + R_1 \times R_F] \times (R_F + R_1)} \times \frac{V_{\text{ramp}}}{F_{LC} \times V_{IN}} \rightarrow \quad (\text{eq. 41})$$

$$1.152 \text{ kHz} = \frac{(31.6 \text{ k}\Omega + 20 \text{ k}\Omega)}{(2\pi)^2 \times (0.96)^2 [(31.6 \text{ k}\Omega + 20 \text{ k}\Omega) \times 10 \text{ k}\Omega + 31.6 \text{ k}\Omega \times 20 \text{ k}\Omega] \times (20 \text{ k}\Omega + 31.6 \text{ k}\Omega)} \times \frac{1.1 \text{ V}}{3.102 \text{ kHz} \times 12 \text{ V}}$$

$C_F$  = Feed through capacitor  
 $F_{LC}$  = Frequency of the output inductor and capacitor  
 $F_{PO}$  = Pole frequency  
 $R_1$  = Top of resistor divider  
 $R_2$  = Bottom of resistor divider  
 $R_F$  = Feed through resistor  
 $V_{IN}$  = Input voltage  
 $V_{\text{ramp}}$  = Peak-to-peak voltage of the ramp

The cross over combined compensation network can be used to calculate the transconductance output compensation network as follows:

$$C_C = \frac{1}{F_{PO}} \times \frac{R_2}{R_2 \times R_1} \times gm \rightarrow \quad (\text{eq. 42})$$

$$84 \text{ nF} = \frac{1}{1.152 \text{ kHz}} \times \frac{10 \text{ k}\Omega}{10 \text{ k}\Omega + 31.6 \text{ k}\Omega} \times 4 \text{ ms}$$

$C_C$  = Compensation capacitor  
 $F_{PO}$  = Pole frequency  
 $gm$  = Transconductance of amplifier  
 $R_1$  = Top of resistor divider  
 $R_2$  = Bottom of resistor divider



## NCP3125

$$R_C = \frac{1}{2 \times F_{LC} \times C_C \times \left( \sqrt{2}/2 + f_{cross} \times CO_{ESR} \times C_{OUT} \right)} \quad (\text{eq. 43})$$

$$1.355 \text{ k}\Omega = \frac{1}{2 \times 3.102 \text{ kHz} \times 84 \text{ nF} \times \left( \sqrt{2}/2 + 30 \text{ kHz} \times 0.05 \text{ m}\Omega \times 470 \text{ }\mu\text{F} \right)}$$

$C_C$  = Compensation capacitance  
 $CO_{ESR}$  = Output capacitor ESR  
 $C_{OUT}$  = Output capacitance  
 $f_{cross}$  = Crossover frequency  
 $F_{LC}$  = Output inductor and capacitor frequency  
 $R_C$  = Compensation resistor

$$C_P = C_{OUT} \times \frac{CO_{ESR}}{R_C \times 2 \times \pi} \rightarrow \quad (\text{eq. 44})$$

$$2.76 \text{ nF} = 470 \text{ }\mu\text{F} \times \frac{0.05 \text{ m}\Omega}{1.355 \text{ k}\Omega \times 2 \times \pi}$$

$CO_{ESR}$  = Output capacitor ESR  
 $C_{OUT}$  = Output capacitor  
 $C_P$  = Compensation pole capacitor  
 $R_C$  = Compensation resistor

Assuming an output capacitance of 470  $\mu\text{F}$  in parallel with 22  $\mu\text{F}$  with a crossover frequency of 35 kHz, the compensation values for common output voltages can be calculated as shown in Table 6:

**Table 6. COMPENSATION VALUES**

$V_{in}$ (V)	$V_{out}$ (V)	$L_{out}$ ( $\mu\text{F}$ )	$R_F$ ( $\text{k}\Omega$ )	$C_f$ (nF)	$C_c$ (nF)	$R_c$ ( $\text{k}\Omega$ )	$C_p$ (nF)
12	0.8	2.2	X	X	150	0.243	5.6
12	1.2	2.7	20	1	100	0.412	2.7
12	1.5	2.7	20	1	100	0.487	2.7
12	1.8	3.9	20	1	120	0.806	1.8
12	2.5	4.7	20	1	82	1.07	1.5
12	3.3	5.6	20	1	68	1.4	1.2
12	5.0	6.8	20	1	47	1.96	0.82
5	0.8	1.8	20	1	68	0.453	1
5	1.2	2.7	20	1	56	0.953	1
5	1.5	2.7	20	1	39	1.15	0.82
5	1.8	3.3	20	1	33	1.5	0.68
5	2.5	3.3	20	1	27	1.82	0.56

**Calculating Soft-Start Time**

To calculate the soft-start delay and soft-start time, the following equations can be used.

$$t_{SS\text{delay}} = \frac{(C_P + C_C) \times 0.9 \text{ V}}{I_{SS}} \rightarrow \text{(eq. 45)}$$

$$7.45 \text{ ms} = \frac{(2.83 \text{ nF} + 80 \text{ nF}) \times 0.9 \text{ V}}{10 \mu\text{A}}$$

- $C_P$  = Compensation pole capacitor
- $C_C$  = Compensation capacitor
- $I_{SS}$  = Soft-start current

The time the output voltage takes to increase from 0 V to a regulated output voltage is  $t_{SS}$  as shown in Equation 46:

$$t_{SS} = \frac{(C_P + C_C) \times D \times V_{\text{ramp}}}{I_{SS}} \text{(eq. 46)}$$

$$2.51 \text{ ms} = \frac{(2.83 \text{ nF} + 80 \text{ nF}) \times 27.5\% \times 1.1 \text{ V}}{10 \mu\text{A}}$$

- $C_P$  = Compensation pole capacitor
- $C_C$  = Compensation capacitor
- $D$  = Duty ratio
- $I_{SS}$  = Soft-start current
- $t_{SS}$  = Soft-start interval
- $V_{\text{ramp}}$  = Peak-to-peak voltage of the ramp

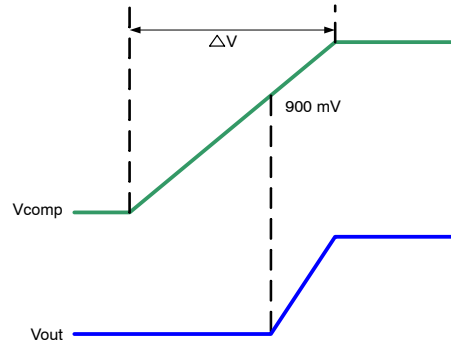

**Figure 25. Soft-Start Ramp**

The delay from the charging of the compensation network to the bottom of the ramp is considered  $t_{SS\text{delay}}$ . The total delay time is the addition of the current set delay and  $t_{SS\text{delay}}$ , which in this case is 9 ms and 7.45 ms respectively, for a total of 16.45 ms.

**Calculating Input Inrush Current**

The input inrush current has two distinct stages: input charging and output charging. The input charging of a buck stage is usually not controlled, and is limited only by the input RC network, and the output impedance of the upstream power stage. If the upstream power stage is a perfect voltage source, then the input charge inrush current can be depicted as shown in Figure 26 and calculated as:



**Figure 26. Input Charge Inrush Current**

$$I_{Cinrush\_PK1} = \frac{V_{IN}}{CIN_{ESR}} \text{(eq. 47)}$$

$$120 \text{ A} = \frac{12}{0.1}$$

$$I_{ICinrush\_RMS}^1 = \frac{V_{IN}}{CIN_{ESR}} \times \left[ 1 - \frac{1}{e^{\left[ \frac{t_{DELAY\_TOTAL}}{CIN_{ESR} \times C_{IN}} \right]}} \right] \times 0.316 \times \frac{5 \times CIN_{ESR} \times C_{IN}}{t_{DELAY\_TOTAL}} \quad (\text{eq. 48})$$

$$380 \text{ mA} = \frac{12 \text{ V}}{0.1 \Omega} \times \left[ 1 - \frac{1}{e^{\left[ \frac{16.45 \text{ ms}}{0.1 \Omega \times 330 \mu\text{F}} \right]}} \right] \times 0.316 \times \frac{5 \times 0.1 \Omega \times 330 \mu\text{F}}{16.45 \text{ ms}}$$

- $C_{IN}$  = Output capacitor
- $CIN_{ESR}$  = Output capacitor ESR
- $t_{DELAY\_TOTAL}$  = Total delay interval
- $V_{IN}$  = Input voltage

Once the  $t_{DELAY\_TOTAL}$  has expired, the buck converter starts to switch and a second inrush current can be calculated:

$$I_{OCinrush\_RMS} = \frac{(C_{OUT} + C_{LOAD}) \times V_{OUT} D}{t_{SS} \sqrt{3}} + I_{CL} \times D \quad (\text{eq. 49})$$

- $C_{OUT}$  = Total converter output capacitance
- $C_{LOAD}$  = Total load capacitance
- $D$  = Duty ratio of the load
- $I_{CL}$  = Applied load at the output
- $I_{OCinrush\_RMS}$  = RMS inrush current during start-up
- $t_{SS}$  = Soft-start interval
- $V_{OUT}$  = Output voltage

From the above equation, it is clear that the inrush current is dependant on the type of load that is connected to the output. Two types of load are considered in Figure 27: a resistive load and a stepped current load.

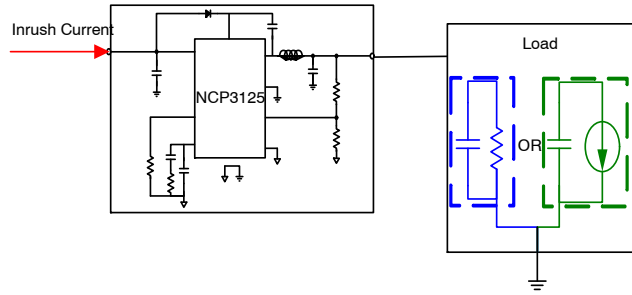

Figure 27. Load Connected to the Output Stage

If the load is resistive in nature, the output current will increase with soft-start linearly which can be quantified in Equation 50.

$$I_{CLR\_RMS} = \frac{1}{\sqrt{3}} \times \frac{V_{OUT}}{R_{OUT}} \quad I_{CR\_PK} = \frac{V_{OUT}}{R_{OUT}} \quad (\text{eq. 50})$$

$$191 \text{ mA} = \frac{1}{\sqrt{3}} \times \frac{3.3 \text{ V}}{10 \Omega} \quad 330 \text{ mA} = \frac{3.3 \text{ V}}{10 \Omega}$$

- $R_{OUT}$  = Output resistance
- $V_{OUT}$  = Output voltage
- $I_{CLR\_RMS}$  = RMS resistor current
- $I_{CR\_PK}$  = Peak resistor current

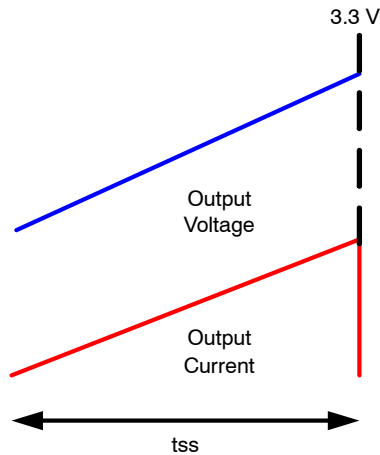

Figure 28. Resistive Load Current

Alternatively, if the output has an under voltage lockout, turns on at a defined voltage level, and draws a consistent current, then the RMS connected load current is:

$$I_{CLI} = \sqrt{\frac{V_{OUT} - V_{OUT\_TO}}{V_{OUT}}} \times I_{OUT} \quad (\text{eq. 51})$$

$$798 \text{ mA} = \sqrt{\left(\frac{3.3 \text{ V} - 1.2 \text{ V}}{3.3 \text{ V}}\right)} \times 1 \text{ A}$$

$I_{OUT}$  = Output current  
 $V_{OUT}$  = Output voltage  
 $V_{OUT\_TO}$  = Output voltage load turn on

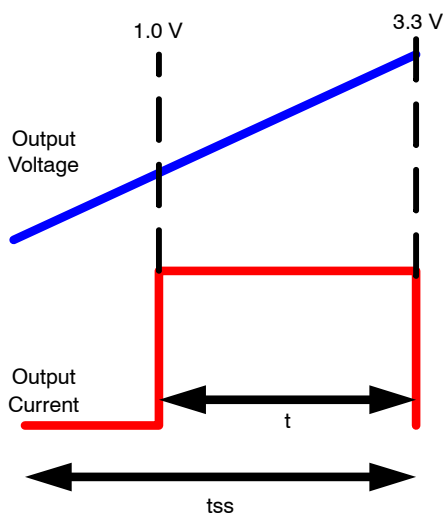
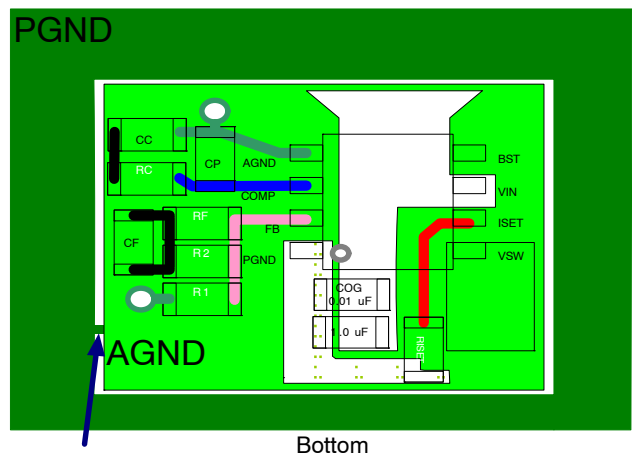
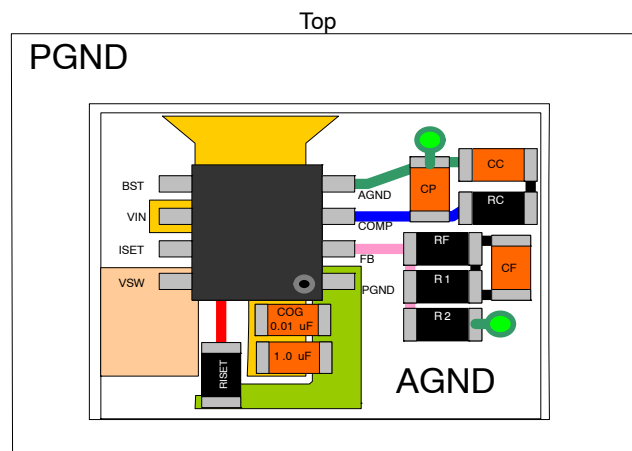

Figure 29. Voltage Enable Load Current

If the inrush current is higher than the steady state input current during max load, then an input fuse should be rated accordingly using  $I^2t$  methodology.

**Layout Considerations**

As in any high frequency switching regulator, layout is very important. Switching current from one power device to another can generate voltage transients across the impedances of the interconnecting bond wires and circuit traces. The interconnecting impedances should be minimized by using wide short printed circuit traces. The critical components should be located as close together as possible using ground plane construction or single point grounding. For optimal performance, the NCP3125 should have a layout similar to the one shown in Figure 30. An important note is that the input voltage to the NCP3125 should have local decoupling to PGND. The recommended decoupling for input voltage is a 1  $\mu\text{F}$  general purpose ceramic capacitor and a 0.01  $\mu\text{F}$  COG ceramic capacitor placed in parallel.



Single Point Grounding

Figure 30. Recommended Layout

The typical applications are shown in Figures 31 and 32 for output electrolytic and ceramic bulk capacitors, respectively.



# MECHANICAL CASE OUTLINE PACKAGE DIMENSIONS

ON Semiconductor®



SCALE 1:1

SOIC-8 NB  
CASE 751-07  
ISSUE AK

DATE 16 FEB 2011



- NOTES:
1. DIMENSIONING AND TOLERANCING PER ANSI Y14.5M, 1982.
  2. CONTROLLING DIMENSION: MILLIMETER.
  3. DIMENSION A AND B DO NOT INCLUDE MOLD PROTRUSION.
  4. MAXIMUM MOLD PROTRUSION 0.15 (0.006) PER SIDE.
  5. DIMENSION D DOES NOT INCLUDE DAMBAR PROTRUSION. ALLOWABLE DAMBAR PROTRUSION SHALL BE 0.127 (0.005) TOTAL IN EXCESS OF THE D DIMENSION AT MAXIMUM MATERIAL CONDITION.
  6. 751-01 THRU 751-06 ARE OBSOLETE. NEW STANDARD IS 751-07.

DIM	MILLIMETERS		INCHES	
	MIN	MAX	MIN	MAX
A	4.80	5.00	0.189	0.197
B	3.80	4.00	0.150	0.157
C	1.35	1.75	0.053	0.069
D	0.33	0.51	0.013	0.020
G	1.27 BSC		0.050 BSC	
H	0.10	0.25	0.004	0.010
J	0.19	0.25	0.007	0.010
K	0.40	1.27	0.016	0.050
M	0°	8°	0°	8°
N	0.25	0.50	0.010	0.020
S	5.80	6.20	0.228	0.244

## GENERIC MARKING DIAGRAM\*

### SOLDERING FOOTPRINT\*

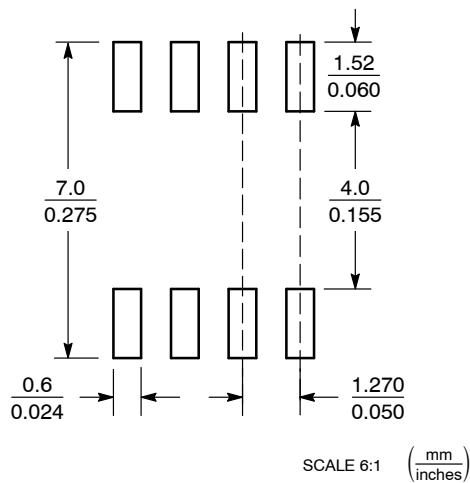

XXXXXX = Specific Device Code  
A = Assembly Location  
L = Wafer Lot  
Y = Year  
W = Work Week  
▪ = Pb-Free Package

XXXXXX = Specific Device Code  
A = Assembly Location  
Y = Year  
WW = Work Week  
▪ = Pb-Free Package

\*This information is generic. Please refer to device data sheet for actual part marking. Pb-Free indicator, "G" or microdot "▪", may or may not be present. Some products may not follow the Generic Marking.

\*For additional information on our Pb-Free strategy and soldering details, please download the ON Semiconductor Soldering and Mounting Techniques Reference Manual, SOLDERRM/D.

STYLES ON PAGE 2

DOCUMENT NUMBER:	98ASB42564B	Electronic versions are uncontrolled except when accessed directly from the Document Repository. Printed versions are uncontrolled except when stamped "CONTROLLED COPY" in red.
DESCRIPTION:	SOIC-8 NB	PAGE 1 OF 2

ON Semiconductor and ON are trademarks of Semiconductor Components Industries, LLC dba ON Semiconductor or its subsidiaries in the United States and/or other countries. ON Semiconductor reserves the right to make changes without further notice to any products herein. ON Semiconductor makes no warranty, representation or guarantee regarding the suitability of its products for any particular purpose, nor does ON Semiconductor assume any liability arising out of the application or use of any product or circuit, and specifically disclaims any and all liability, including without limitation special, consequential or incidental damages. ON Semiconductor does not convey any license under its patent rights nor the rights of others.

**SOIC-8 NB**  
**CASE 751-07**  
**ISSUE AK**

DATE 16 FEB 2011

- |  |   |   |   |
|--|---|---|---|
| <p><b>STYLE 1:</b><br/> PIN 1. EMITTER<br/> 2. COLLECTOR<br/> 3. COLLECTOR<br/> 4. EMITTER<br/> 5. EMITTER<br/> 6. BASE<br/> 7. BASE<br/> 8. EMITTER</p>   | <p><b>STYLE 2:</b><br/> PIN 1. COLLECTOR, DIE, #1<br/> 2. COLLECTOR, #1<br/> 3. COLLECTOR, #2<br/> 4. COLLECTOR, #2<br/> 5. BASE, #2<br/> 6. EMITTER, #2<br/> 7. BASE, #1<br/> 8. EMITTER, #1</p>               | <p><b>STYLE 3:</b><br/> PIN 1. DRAIN, DIE #1<br/> 2. DRAIN, #1<br/> 3. DRAIN, #2<br/> 4. DRAIN, #2<br/> 5. GATE, #2<br/> 6. SOURCE, #2<br/> 7. GATE, #1<br/> 8. SOURCE, #1</p>                            | <p><b>STYLE 4:</b><br/> PIN 1. ANODE<br/> 2. ANODE<br/> 3. ANODE<br/> 4. ANODE<br/> 5. ANODE<br/> 6. ANODE<br/> 7. ANODE<br/> 8. COMMON CATHODE</p>   |
| <p><b>STYLE 5:</b><br/> PIN 1. DRAIN<br/> 2. DRAIN<br/> 3. DRAIN<br/> 4. DRAIN<br/> 5. GATE<br/> 6. GATE<br/> 7. SOURCE<br/> 8. SOURCE</p>   | <p><b>STYLE 6:</b><br/> PIN 1. SOURCE<br/> 2. DRAIN<br/> 3. DRAIN<br/> 4. SOURCE<br/> 5. SOURCE<br/> 6. GATE<br/> 7. GATE<br/> 8. SOURCE</p>  | <p><b>STYLE 7:</b><br/> PIN 1. INPUT<br/> 2. EXTERNAL BYPASS<br/> 3. THIRD STAGE SOURCE<br/> 4. GROUND<br/> 5. DRAIN<br/> 6. GATE 3<br/> 7. SECOND STAGE Vd<br/> 8. FIRST STAGE Vd</p>                    | <p><b>STYLE 8:</b><br/> PIN 1. COLLECTOR, DIE #1<br/> 2. BASE, #1<br/> 3. BASE, #2<br/> 4. COLLECTOR, #2<br/> 5. COLLECTOR, #2<br/> 6. EMITTER, #2<br/> 7. EMITTER, #1<br/> 8. COLLECTOR, #1</p>                              |
| <p><b>STYLE 9:</b><br/> PIN 1. EMITTER, COMMON<br/> 2. COLLECTOR, DIE #1<br/> 3. COLLECTOR, DIE #2<br/> 4. EMITTER, COMMON<br/> 5. EMITTER, COMMON<br/> 6. BASE, DIE #2<br/> 7. BASE, DIE #1<br/> 8. EMITTER, COMMON</p> | <p><b>STYLE 10:</b><br/> PIN 1. GROUND<br/> 2. BIAS 1<br/> 3. OUTPUT<br/> 4. GROUND<br/> 5. GROUND<br/> 6. BIAS 2<br/> 7. INPUT<br/> 8. GROUND</p>  | <p><b>STYLE 11:</b><br/> PIN 1. SOURCE 1<br/> 2. GATE 1<br/> 3. SOURCE 2<br/> 4. GATE 2<br/> 5. DRAIN 2<br/> 6. DRAIN 2<br/> 7. DRAIN 1<br/> 8. DRAIN 1</p>   | <p><b>STYLE 12:</b><br/> PIN 1. SOURCE<br/> 2. SOURCE<br/> 3. SOURCE<br/> 4. GATE<br/> 5. DRAIN<br/> 6. DRAIN<br/> 7. DRAIN<br/> 8. DRAIN</p>   |
| <p><b>STYLE 13:</b><br/> PIN 1. N.C.<br/> 2. SOURCE<br/> 3. SOURCE<br/> 4. GATE<br/> 5. DRAIN<br/> 6. DRAIN<br/> 7. DRAIN<br/> 8. DRAIN</p>  | <p><b>STYLE 14:</b><br/> PIN 1. N-SOURCE<br/> 2. N-GATE<br/> 3. P-SOURCE<br/> 4. P-GATE<br/> 5. P-DRAIN<br/> 6. P-DRAIN<br/> 7. N-DRAIN<br/> 8. N-DRAIN</p>   | <p><b>STYLE 15:</b><br/> PIN 1. ANODE 1<br/> 2. ANODE 1<br/> 3. ANODE 1<br/> 4. ANODE 1<br/> 5. CATHODE, COMMON<br/> 6. CATHODE, COMMON<br/> 7. CATHODE, COMMON<br/> 8. CATHODE, COMMON</p>               | <p><b>STYLE 16:</b><br/> PIN 1. EMITTER, DIE #1<br/> 2. BASE, DIE #1<br/> 3. EMITTER, DIE #2<br/> 4. BASE, DIE #2<br/> 5. COLLECTOR, DIE #2<br/> 6. COLLECTOR, DIE #2<br/> 7. COLLECTOR, DIE #1<br/> 8. COLLECTOR, DIE #1</p> |
| <p><b>STYLE 17:</b><br/> PIN 1. VCC<br/> 2. V2OUT<br/> 3. V1OUT<br/> 4. TXE<br/> 5. RXE<br/> 6. VEE<br/> 7. GND<br/> 8. ACC</p>  | <p><b>STYLE 18:</b><br/> PIN 1. ANODE<br/> 2. ANODE<br/> 3. SOURCE<br/> 4. GATE<br/> 5. DRAIN<br/> 6. DRAIN<br/> 7. CATHODE<br/> 8. CATHODE</p>   | <p><b>STYLE 19:</b><br/> PIN 1. SOURCE 1<br/> 2. GATE 1<br/> 3. SOURCE 2<br/> 4. GATE 2<br/> 5. DRAIN 2<br/> 6. MIRROR 2<br/> 7. DRAIN 1<br/> 8. MIRROR 1</p>   | <p><b>STYLE 20:</b><br/> PIN 1. SOURCE (N)<br/> 2. GATE (N)<br/> 3. SOURCE (P)<br/> 4. GATE (P)<br/> 5. DRAIN<br/> 6. DRAIN<br/> 7. DRAIN<br/> 8. DRAIN</p>   |
| <p><b>STYLE 21:</b><br/> PIN 1. CATHODE 1<br/> 2. CATHODE 2<br/> 3. CATHODE 3<br/> 4. CATHODE 4<br/> 5. CATHODE 5<br/> 6. COMMON ANODE<br/> 7. COMMON ANODE<br/> 8. CATHODE 6</p>  | <p><b>STYLE 22:</b><br/> PIN 1. I/O LINE 1<br/> 2. COMMON CATHODE/VCC<br/> 3. COMMON CATHODE/VCC<br/> 4. I/O LINE 3<br/> 5. COMMON ANODE/GND<br/> 6. I/O LINE 4<br/> 7. I/O LINE 5<br/> 8. COMMON ANODE/GND</p> | <p><b>STYLE 23:</b><br/> PIN 1. LINE 1 IN<br/> 2. COMMON ANODE/GND<br/> 3. COMMON ANODE/GND<br/> 4. LINE 2 IN<br/> 5. LINE 2 OUT<br/> 6. COMMON ANODE/GND<br/> 7. COMMON ANODE/GND<br/> 8. LINE 1 OUT</p> | <p><b>STYLE 24:</b><br/> PIN 1. BASE<br/> 2. EMITTER<br/> 3. COLLECTOR/ANODE<br/> 4. COLLECTOR/ANODE<br/> 5. CATHODE<br/> 6. CATHODE<br/> 7. COLLECTOR/ANODE<br/> 8. COLLECTOR/ANODE</p>                                      |
| <p><b>STYLE 25:</b><br/> PIN 1. VIN<br/> 2. N/C<br/> 3. REXT<br/> 4. GND<br/> 5. IOUT<br/> 6. IOUT<br/> 7. IOUT<br/> 8. IOUT</p>   | <p><b>STYLE 26:</b><br/> PIN 1. GND<br/> 2. dv/dt<br/> 3. ENABLE<br/> 4. ILIMIT<br/> 5. SOURCE<br/> 6. SOURCE<br/> 7. SOURCE<br/> 8. VCC</p>  | <p><b>STYLE 27:</b><br/> PIN 1. ILIMIT<br/> 2. OVLO<br/> 3. UVLO<br/> 4. INPUT+<br/> 5. SOURCE<br/> 6. SOURCE<br/> 7. SOURCE<br/> 8. DRAIN</p>  | <p><b>STYLE 28:</b><br/> PIN 1. SW_TO_GND<br/> 2. DASIC OFF<br/> 3. DASIC_SW_DET<br/> 4. GND<br/> 5. V_MON<br/> 6. VBULK<br/> 7. VBULK<br/> 8. VIN</p>  |
| <p><b>STYLE 29:</b><br/> PIN 1. BASE, DIE #1<br/> 2. EMITTER, #1<br/> 3. BASE, #2<br/> 4. EMITTER, #2<br/> 5. COLLECTOR, #2<br/> 6. COLLECTOR, #2<br/> 7. COLLECTOR, #1<br/> 8. COLLECTOR, #1</p>                        | <p><b>STYLE 30:</b><br/> PIN 1. DRAIN 1<br/> 2. DRAIN 1<br/> 3. GATE 2<br/> 4. SOURCE 2<br/> 5. SOURCE 1/DRAIN 2<br/> 6. SOURCE 1/DRAIN 2<br/> 7. SOURCE 1/DRAIN 2<br/> 8. GATE 1</p>                           |   |   |

<b>DOCUMENT NUMBER:</b>	<b>98ASB42564B</b>	Electronic versions are uncontrolled except when accessed directly from the Document Repository. Printed versions are uncontrolled except when stamped "CONTROLLED COPY" in red.
<b>DESCRIPTION:</b>	<b>SOIC-8 NB</b>	<b>PAGE 2 OF 2</b>

ON Semiconductor and  are trademarks of Semiconductor Components Industries, LLC dba ON Semiconductor or its subsidiaries in the United States and/or other countries. ON Semiconductor reserves the right to make changes without further notice to any products herein. ON Semiconductor makes no warranty, representation or guarantee regarding the suitability of its products for any particular purpose, nor does ON Semiconductor assume any liability arising out of the application or use of any product or circuit, and specifically disclaims any and all liability, including without limitation special, consequential or incidental damages. ON Semiconductor does not convey any license under its patent rights nor the rights of others.

ON Semiconductor and  are trademarks of Semiconductor Components Industries, LLC dba ON Semiconductor or its subsidiaries in the United States and/or other countries. ON Semiconductor owns the rights to a number of patents, trademarks, copyrights, trade secrets, and other intellectual property. A listing of ON Semiconductor's product/patent coverage may be accessed at [www.onsemi.com/site/pdf/Patent-Marking.pdf](http://www.onsemi.com/site/pdf/Patent-Marking.pdf). ON Semiconductor reserves the right to make changes without further notice to any products herein. ON Semiconductor makes no warranty, representation or guarantee regarding the suitability of its products for any particular purpose, nor does ON Semiconductor assume any liability arising out of the application or use of any product or circuit, and specifically disclaims any and all liability, including without limitation special, consequential or incidental damages. Buyer is responsible for its products and applications using ON Semiconductor products, including compliance with all laws, regulations and safety requirements or standards, regardless of any support or applications information provided by ON Semiconductor. "Typical" parameters which may be provided in ON Semiconductor data sheets and/or specifications can and do vary in different applications and actual performance may vary over time. All operating parameters, including "Typicals" must be validated for each customer application by customer's technical experts. ON Semiconductor does not convey any license under its patent rights nor the rights of others. ON Semiconductor products are not designed, intended, or authorized for use as a critical component in life support systems or any FDA Class 3 medical devices or medical devices with a same or similar classification in a foreign jurisdiction or any devices intended for implantation in the human body. Should Buyer purchase or use ON Semiconductor products for any such unintended or unauthorized application, Buyer shall indemnify and hold ON Semiconductor and its officers, employees, subsidiaries, affiliates, and distributors harmless against all claims, costs, damages, and expenses, and reasonable attorney fees arising out of, directly or indirectly, any claim of personal injury or death associated with such unintended or unauthorized use, even if such claim alleges that ON Semiconductor was negligent regarding the design or manufacture of the part. ON Semiconductor is an Equal Opportunity/Affirmative Action Employer. This literature is subject to all applicable copyright laws and is not for resale in any manner.

## PUBLICATION ORDERING INFORMATION

### LITERATURE FULFILLMENT:

Email Requests to: [orderlit@onsemi.com](mailto:orderlit@onsemi.com)

ON Semiconductor Website: [www.onsemi.com](http://www.onsemi.com)

### TECHNICAL SUPPORT

North American Technical Support:  
Voice Mail: 1 800-282-9855 Toll Free USA/Canada  
Phone: 011 421 33 790 2910

### Europe, Middle East and Africa Technical Support:

Phone: 00421 33 790 2910

For additional information, please contact your local Sales Representative