

■ PRODUCT CLASSIFICATION

● Ordering Information

XC6192①②③④⑤⑥-⑦^(*)

DESIGNATOR	DESCRIPTION	SYMBOL	DESCRIPTION
①	TYPE	A	Turn-on: By the SW pin Shut-down: By the SW pin or the SHDN pin
		B	Turn-on: By the SW pin Shut-down: By the SHDN pin
②	Turn-On delay time	A	0.5s.
		1	1s. option ^{(*)2}
		3	3s. option ^{(*)2}
		5	5s. option ^{(*)2}
③④	Turn-Off delay time	NN	No "Turn-Off delay time" function. Applies to XC6192B only
		03	3s. option ^{(*)2}
		05	5s.
		10	10s.
		15	15s. option ^{(*)2}
⑤⑥-⑦	Package and Taping Type	ER-G	USP-8B06 (5,000pcs/Reel)

^{(*)1} The "-G" suffix denotes Halogen and Antimony free as well as being fully EU RoHS compliant.

^{(*)2} For option products, please contact your local Torex sales office or representative.

● Selection Guide

Parts No.	Turn-On Delay Time (s)	Turn-Off Delay Time (s)	Package
XC6192AA05ER-G	0.5s	5s	USP-8B06
XC6192AA10ER-G		10s	
XC6192BANNER-G		Not applicable	

PIN CONFIGURATION

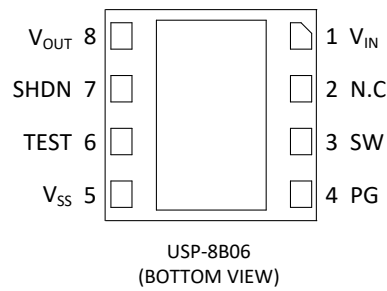

*The dissipation pad for the USP-8B06 package should be solder-plated in recommended mount pattern and metal masking so as to enhance mounting strength and heat release.

When taking out a potential of the heat-sink, connect with V_{SS} pin (#5 pin).

PIN ASSIGNMENT

PIN NUMBER	PIN NAME	FUNCTION
USP-8B06		
1	V_{IN}	Power Supply Input
2	N.C	No connection pin (The N.C pin should be connected the V_{SS} pin.)
3	SW	Push Button Signal input pin
4	PG	Power Good Status Output
5	V_{SS}	Ground Pin
6	TEST	The TEST pin must be connected the V_{SS} pin.
7	SHDN	Forced Shutdown pin
8	V_{OUT}	Output pin

PIN FUNCTIOS ASSIGNMENT

PIN NAME	SIGNAL	STATUS
SW ^(*)	L	Active
	H	Keep the current state
	OPEN	Undefined State ^(*)
SHDN ^(*)	L	Keep the current state
	H	Shut down
	OPEN	Undefined State ^(*)
PG	Low impedance	$V_{OUT} < V_{RUSH}^{(*)}$
	High impedance	$V_{OUT} \geq V_{RUSH}^{(*)}$

^(*) Please do not leave the SW pin and the SHDN pin open. Each should have a certain voltage

^(*) Please refer to electrical characteristics.

^(*) Please refer to notes on use.

■ ABSOLUTE MAXIMUM RATINGS

PARAMETER		SYMBOL	RATINGS	UNITS
V _{IN} Pin Voltage		V _{IN}	-0.3 ~ +6.5	V
V _{OUT} Pin Voltage		V _{OUT}	-0.3 ~ V _{IN} +0.3 or +6.5 ^(*)	V
V _{OUT} Pin Output Current		I _{OUT}	470	mA
SW Pin Voltage		V _{SW}	-0.3 ~ +6.5	V
SHDN Pin Voltage		V _{SHDN}	-0.3 ~ +6.5	V
PG Pin Voltage		V _{PG}	-0.3 ~ +6.5	V
TEST Pin Voltage		V _{TEST}	-0.3 ~ V _{IN} +0.3 or +6.5 ^(*)	V
Power Dissipation (Ta=25°C)	USP-8B06 (DAF)	P _d	1800 (High heat dissipation board) ^(**)	mW
Operating Ambient Temperature		T _{opr}	-40 ~ +85	°C
Storage Temperature		T _{stg}	-55 ~ +125	°C

Each rating voltage is based on the V_{SS}

^(*) Either of lower one, V_{IN}+0.3V or +6.5V, is applicable.

^(**) The power dissipation figure shown is PCB mounted and is for reference only.

The mounting condition is please refer to PACKAGING INFORMATION.

ELECTRICAL CHARACTERISTICS

XC6192 Series

Ta=25°C

PARAMETER	SYMBOL	CONDITIONS	MIN	TYP	MAX	UNIT	CIRCUIT
Input Voltage Range	V _{IN}		2.5	-	6.0	V	(1)
Stand-by Current ⁽¹⁾	I _{STB}	V _{IN} =6.0V, V _{SW} =V _{IN}	-0.10	0.01	0.10	μA	(1)
Operation Current ⁽²⁾	I _{OP}	Turn-Off states, V _{IN} =6.0V, V _{SW} =0V,	-	48	100	μA	(1)
Quiescent Current ⁽³⁾	I _Q	Turn-On keeps, V _{IN} =6.0V, V _{SW} =V _{IN}	-	0.45	1.30	μA	(1)
Turn-On Delay Time ⁽⁴⁾⁽⁹⁾	T _{OND}	XC6192xAxx V _{IN} =3.7V, Change the V _{SW} from V _{IN} to 0V.	0.35	0.50	0.65	s	(1)
		XC6192x1xx V _{IN} =3.7V, Change the V _{SW} from V _{IN} to 0V.	0.70	1.00	1.30		
		XC6192x3xx V _{IN} =3.7V, Change the V _{SW} from V _{IN} to 0V.	2.10	3.00	3.90		
		XC6192x5xx V _{IN} =3.7V, Change the V _{SW} from V _{IN} to 0V.	3.50	5.00	6.50		
Turn-Off Delay Time ⁽⁵⁾⁽⁶⁾⁽⁹⁾	T _{OFFD}	XC6192Ax03 V _{IN} =3.7V, Change the V _{SW} from V _{IN} to 0V.	2.1	3.0	3.9	s	(1)
		XC6192Ax05 V _{IN} =3.7V, Change the V _{SW} from V _{IN} to 0V.	3.5	5.0	6.5		
		XC6192Ax10 V _{IN} =3.7V, Change the V _{SW} from V _{IN} to 0V.	7.0	10.0	13.0		
		XC6192Ax15 V _{IN} =3.7V, Change the V _{SW} from V _{IN} to 0V.	10.5	15.0	19.5		
Inrush Current Limit Voltage	V _{RUSH}	V _{OUT} condition	V _{IN} - 0.23	V _{IN} - 0.13	V _{IN} - 0.05	V	(1)
Short Circuit Detect Voltage	V _{SHORT}	V _{OUT} condition	V _{IN} - 0.98	V _{IN} - 0.66	V _{IN} - 0.32	V	(1)
Pre-driver On Resistor	R _{ONP}	Turn-On states, V _{IN} =2.5V	63	105	139	Ω	(1)
		Turn-On states, V _{IN} =3.7V					(1)
		Turn-On states, V _{IN} =6.0V					(1)
Main Driver On Resistor	R _{ON}	Turn-On states, V _{IN} =2.5V	0.40	0.59	0.78	Ω	(1)
		Turn-On states, V _{IN} =3.7V	0.28	0.45	0.59	Ω	(1)
		Turn-On states, V _{IN} =6.0V	0.20	0.34	0.49	Ω	(1)

Unless otherwise stated, V_{SS} common, V_{IN}=6.0V, V_{SW}=6.0V, V_{SHDN}=0V, V_{PG}=Open, I_{OUT}=0mA, C_{IN}=0.1μF, C_L=0.1μF

(1) Self-supply current when V_{OUT} is in the Turn-off state and V_{IN} level is input into the V_{SW} pin.

(2) Self-supply current when V_{OUT} is in the Turn-off state and "L" level is input into the V_{SW} pin.

(3) Self-supply current when V_{OUT} is in the Turn-on state and V_{IN} level is input into the V_{SW} pin.

(4) Time from SW pin "L" level until V_{OUT} pin "H" level⁽⁷⁾ pin in the Turn-off state.

(5) Time from SW pin "L" level until V_{OUT} pin "L" level⁽⁸⁾ pin in the Turn-on state.

(6) Type B does not have this function.

(9) Electrical characteristics are characteristics before mounting on PCB. Refer to the Usage Cautions.

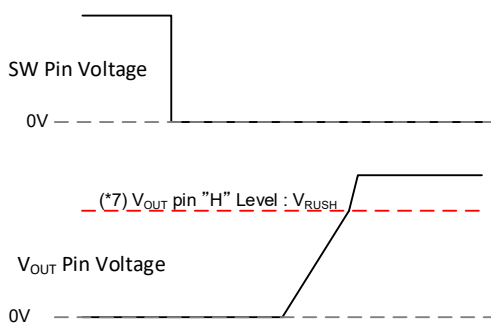

Fig1. V_{OUT} pin "H" Voltage

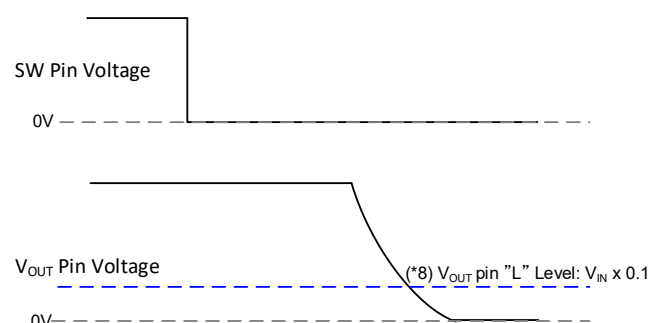

Fig2. V_{OUT} pin "L" Voltage

■ ELECTRICAL CHARACTERISTICS

XC6192 Series

Ta=25°C

PARAMETER	SYMBOL	CONDITIONS	MIN	TYP	MAX	UNIT	CIRCUIT
SW pin "H" Voltage	V_{SWH}		1.1	-	6.0	V	(1)
SW pin "L" Voltage	V_{SWL}		0	-	0.4	V	(1)
SW pin "H" Current	I_{SWH}	$V_{SW}=6.0V$	-0.10	0.01	0.10	μA	(1)
SW pin "L" Current	I_{SWL}	$V_{SW}=0V$	-0.10	0.01	0.10	μA	(1)
SHDN pin "H" Voltage	V_{SHDNH}		1.1	-	6.0	V	(1)
SHDN pin "L" Voltage	V_{SHDNL}		0	-	0.4	V	(1)
SHDN pin "H" Current	I_{SHDNH}	$V_{SHDN}=6.0V$	-0.10	0.01	0.10	μA	(1)
SHDN pin "L" Current	I_{SHDNL}	$V_{SHDN}=0V$	-0.10	0.01	0.10	μA	(1)
PG pin Output Current	I_{PG}	Turn-Off States, $V_{IN}=2.5V$, $V_{PG}=0.3V$	1	-	-	mA	(1)
PG pin Leak Current	I_{PGL}	Turn-On states, $V_{IN}=6.0V$, $V_{PG}=6.0V$	-0.10	0.01	0.10	μA	(1)
CL Discharge Current	I_{DCG}	Turn-Off States, $V_{IN}=2.5V$, $V_{OUT}=0.3V$	1	-	-	mA	(1)

Unless otherwise stated, V_{SS} common, $V_{IN}=6.0V$, $V_{SW}=6.0V$, $V_{SHDN}=0V$, $V_{PG}=\text{Open}$, $I_{OUT}=0mA$, $C_{IN}=0.1\mu F$, $C_L=0.1\mu F$

■ TEST CIRCUITS

Test Circuit (1)

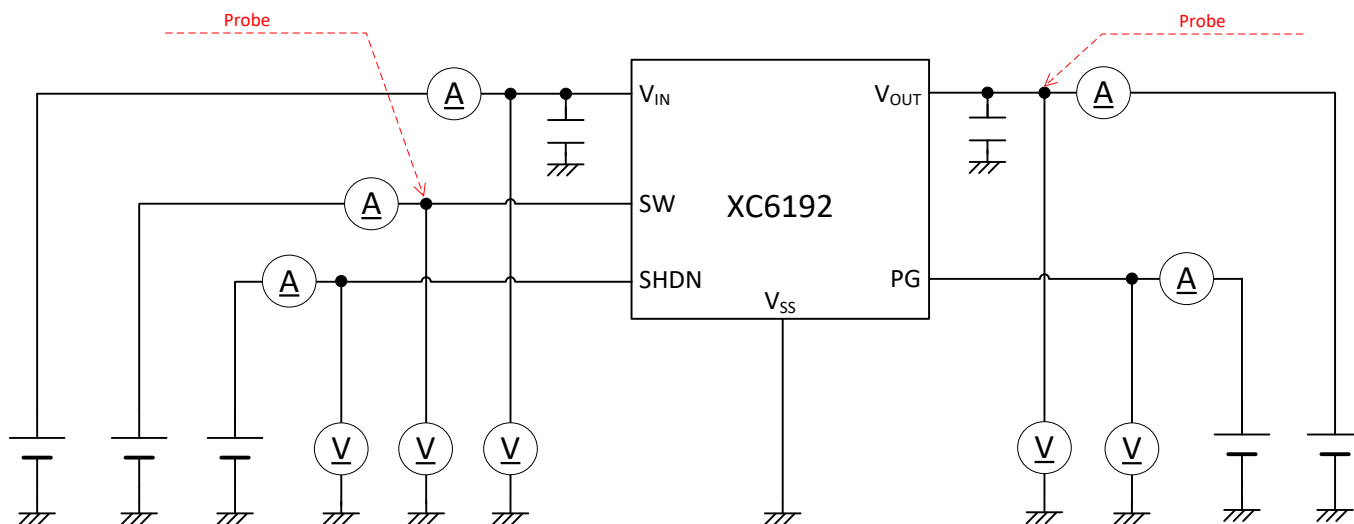

TYPICAL APPLICATION CIRCUIT

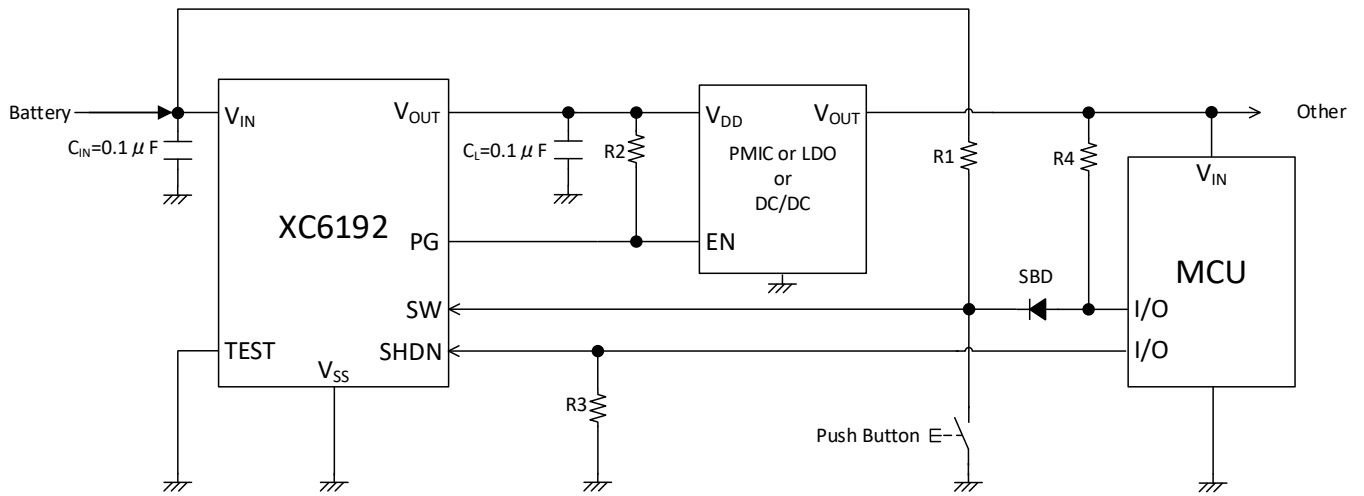

【Typical Examples】

	VALUE	MANUFACTURER	PRODUCT NUMBER
SBD ^(*)	$V_F = 0.37V$	TOREX	XBS013V1DR-G
C_{IN}	0.1 μ F/10V (Ceramic)		
C_L	0.1 μ F/10V (Ceramic)		
R1	200k Ω		
R2	200k Ω		
R3	20k Ω		
R4	200k Ω		

(*) Please select freely according to the threshold of the MCU's I/O.

OPERATIONAL EXPLANATION

The XC6192 series A type fixes V_{OUT} at "H" voltage (same level as the V_{IN} pin voltage) when "L" voltage is input the required time into the SW pin, and shuts down V_{OUT} (same level as GND) when "L" voltage is subsequently input the required time into the SW pin, thereby realizing alternating ON/OFF control^(*). Two shutdown methods are available: inputting "H" voltage into the SHDN pin, and inputting "L" voltage the required time into the SW pin.

^(*) Alternating ON/OFF control on this IC is a system that alternates between V_{OUT} "H" voltage and shutdown each time "L" voltage is input the required time into the SW pin.

The B type fixes V_{OUT} at "H" voltage when "L" voltage is input the required time into the SW pin. After V_{OUT} is fixed at "H" voltage, the signal is not accepted if "L" voltage is subsequently input into the SW pin. The shutdown method is inputting "H" voltage into the SHDN pin.

As protective functions, the XC6192 series is equipped with a rush current prevention circuit and a short-circuit protection circuit.

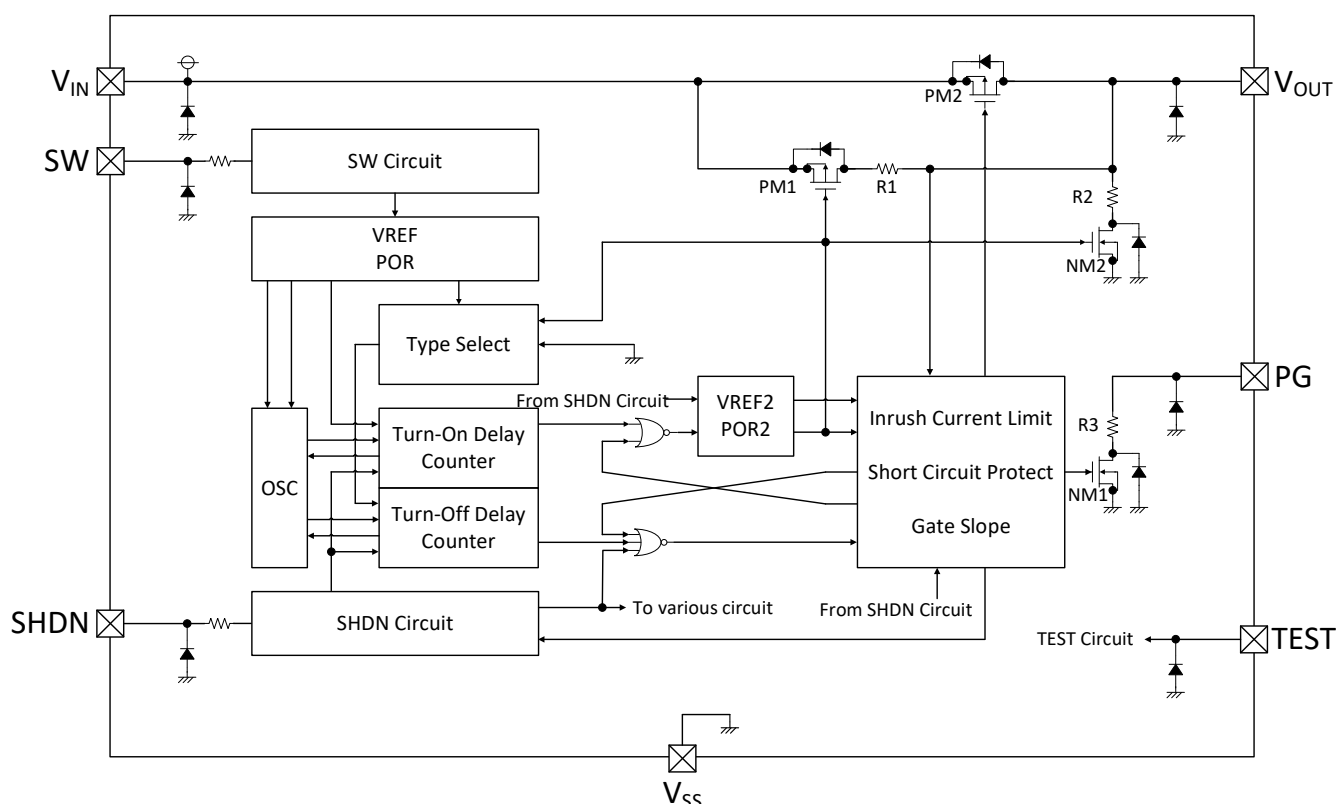

Fig.1 XC6192A Block diagram

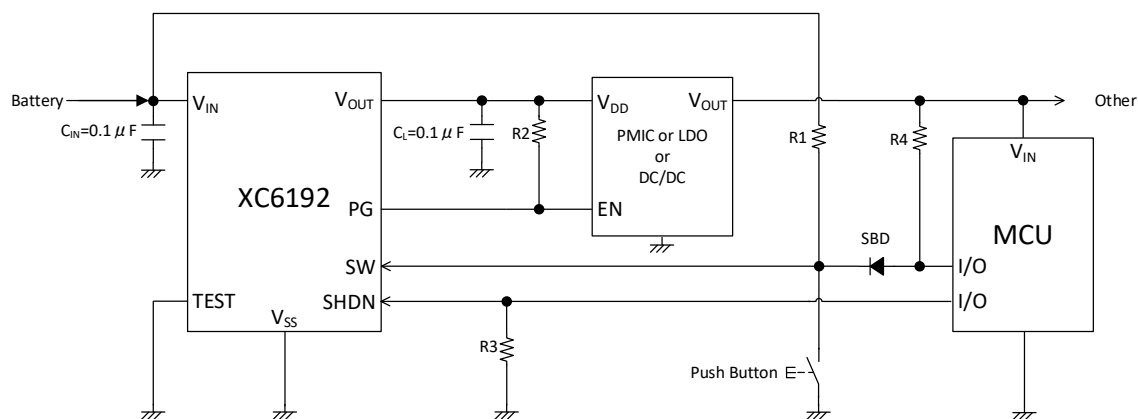

Fig.2 XC6192 Series Typical application circuit

OPERATIONAL EXPLANATION (Continued)

[Turn-On sequence: Fig.3]

On the XC6192 series, when “L” voltage is input for the duration T_{OND} into the SW pin with V_{OUT} fixed at “L” voltage, the Pch pre-driver transistor PM1 (Fig.1) turns ON and V_{OUT} starts to rise. If the SW pin is switched from “L” voltage to “H” voltage while V_{OUT} is rising by PM1, V_{OUT} will change to the shutdown state.

When the V_{OUT} pin voltage reaches Inrush Current Limit Voltage (V_{RUSH} : refer to Electrical Characteristics), the main driver transistor PM2 (Fig.1) turns ON, and V_{OUT} is fixed at “H” voltage even if the SW pin voltage changes to “H” voltage.

When the V_{OUT} pin voltage reaches V_{RUSH} , the Nch transistor NM1 that is connected to the PG pin (Fig.1) turns OFF and the PG pin changes to high impedance.

These operations suppress rush current to the capacitor that is connected to the V_{OUT} pin and allow the input power supply to maintain stability. In addition, by connecting the PG pin to the Enable pin of the device that follows the XC6192 series, malfunctioning of that device is prevented. (Fig.2)

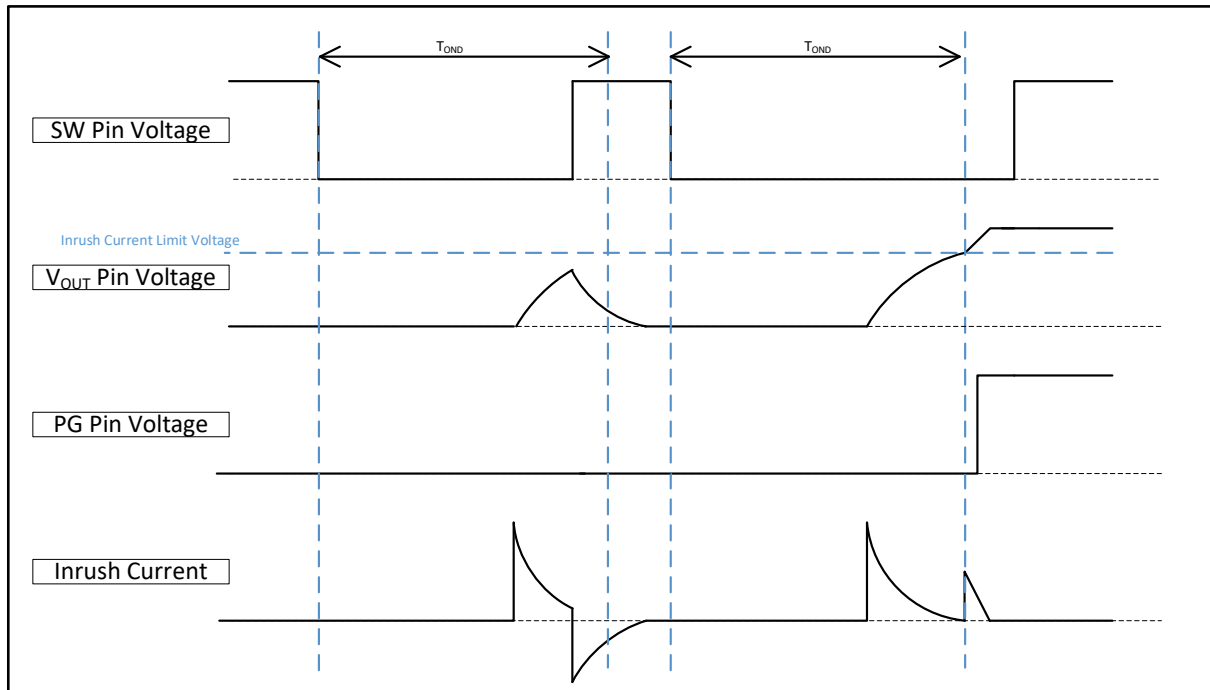

Fig.3 Turn-On sequence

OPERATIONAL EXPLANATION (Continued)

[Shutdown sequence: Fig.4]

On the XC6192 series, when one pulse of “H” voltage (at least 1ms as a guideline) is input into the SDHN pin with V_{OUT} fixed at “H” voltage, V_{OUT} changes to the shutdown state and the IC enters the standby state.

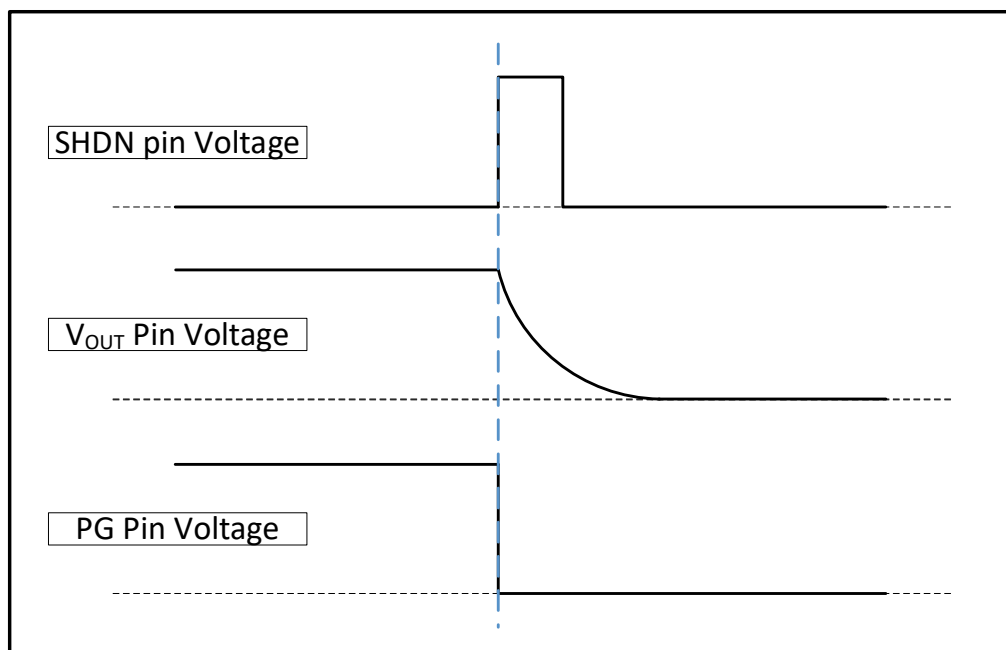

Fig.4 shutdown sequence

[Turn-Off sequence: Fig.5]

On the A type, when “L” voltage is input into the SW pin for the duration T_{OFFD} with V_{OUT} fixed at “H” voltage, V_{OUT} shuts down. After shutdown, returning the SW pin to “H” voltage reduces the supply current to the standby current while holding the IC’s logic.

The B type does not have this function.

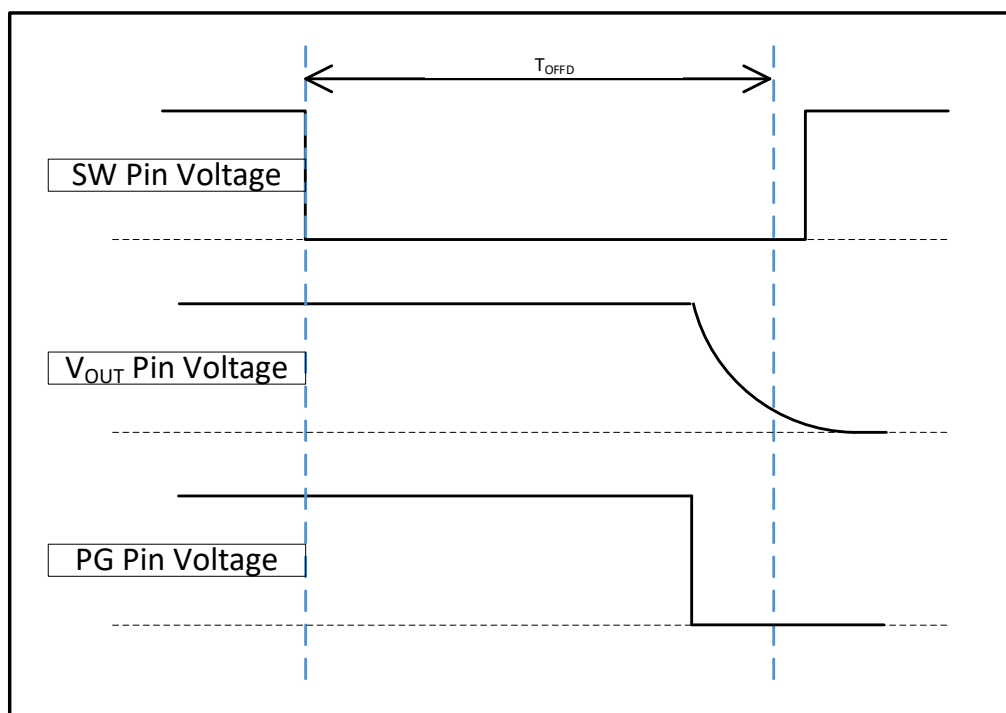

Fig.5 Turn-Off sequence

OPERATIONAL EXPLANATION (Continued)

[Operation after Turn-On: Fig. 6]

On the A type, when “L” voltage is input into the SW pin for the duration T_{OND} and V_{OUT} is fixed at “H” voltage, and then “L” voltage is input into the SW pin for the duration T_{OFFD} , the Turn-Off sequence cannot be initiated. To initiate the Turn-Off sequence, “H” voltage must be input into the SW pin, and then “L” voltage must again be input for the duration T_{OFFD} . The B type does not have a Turn-Off sequence by SW pin.

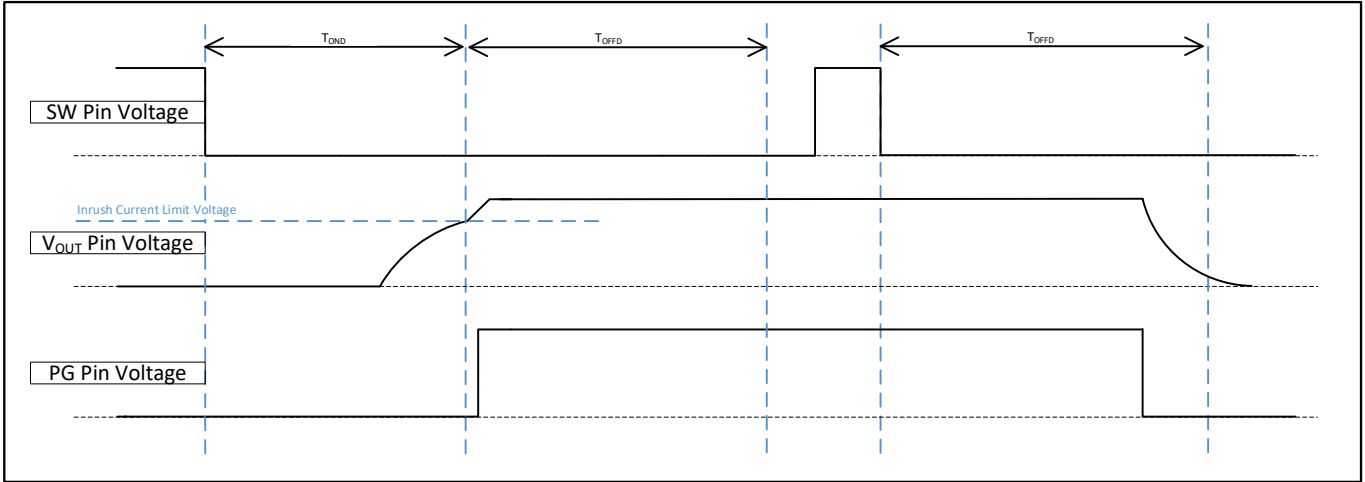

Fig.6 Operation after Turn-On.

[Operation after Turn-Off: Fig.7]

On the A type, when “L” voltage is input into the SW pin for the duration T_{OFFD} and V_{OUT} is shut down, and then “L” voltage is input into the SW pin for the duration T_{OND} , the Turn-On sequence cannot be initiated. To initiate the Turn-On sequence, “H” voltage must be input into the SW pin, and then “L” voltage must again be input for the duration T_{OND} .

The B type does not have a Turn-Off sequence by SW pin.

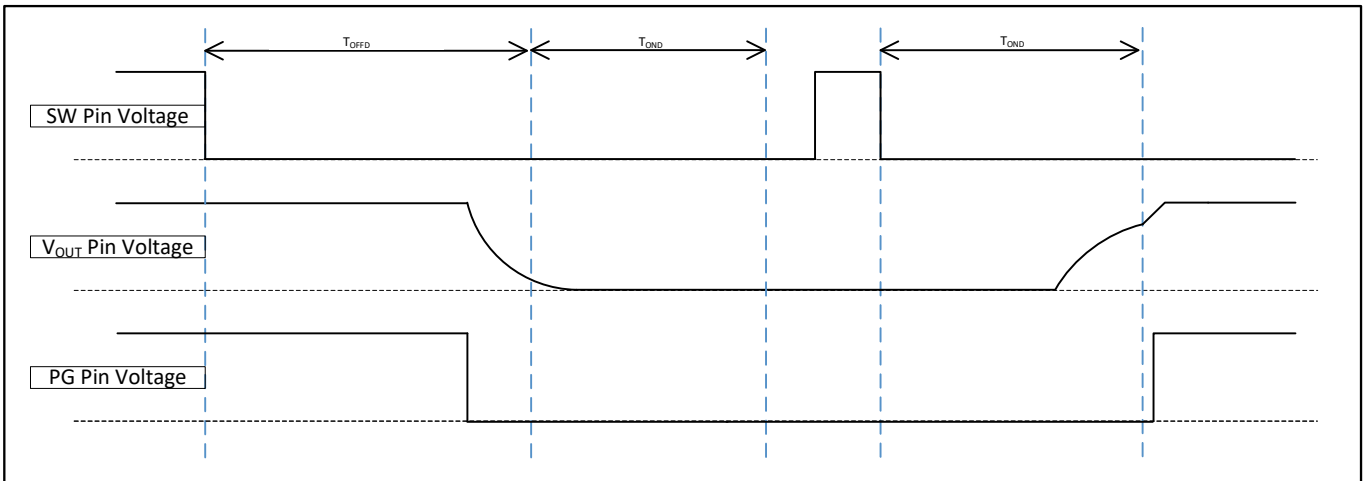

Fig.7 Operation after Turn-Off.

■ OPERATIONAL EXPLANATION (Continued)

[Operation after shutdown: Fig. 8]

On the XC6192 series, in order to initiate the Turn-On sequence after “H” voltage is input into the SHDN pin and V_{OUT} is shut down, “H” voltage must be input into the SW pin and then “L” voltage must again be input for the duration T_{OND} .

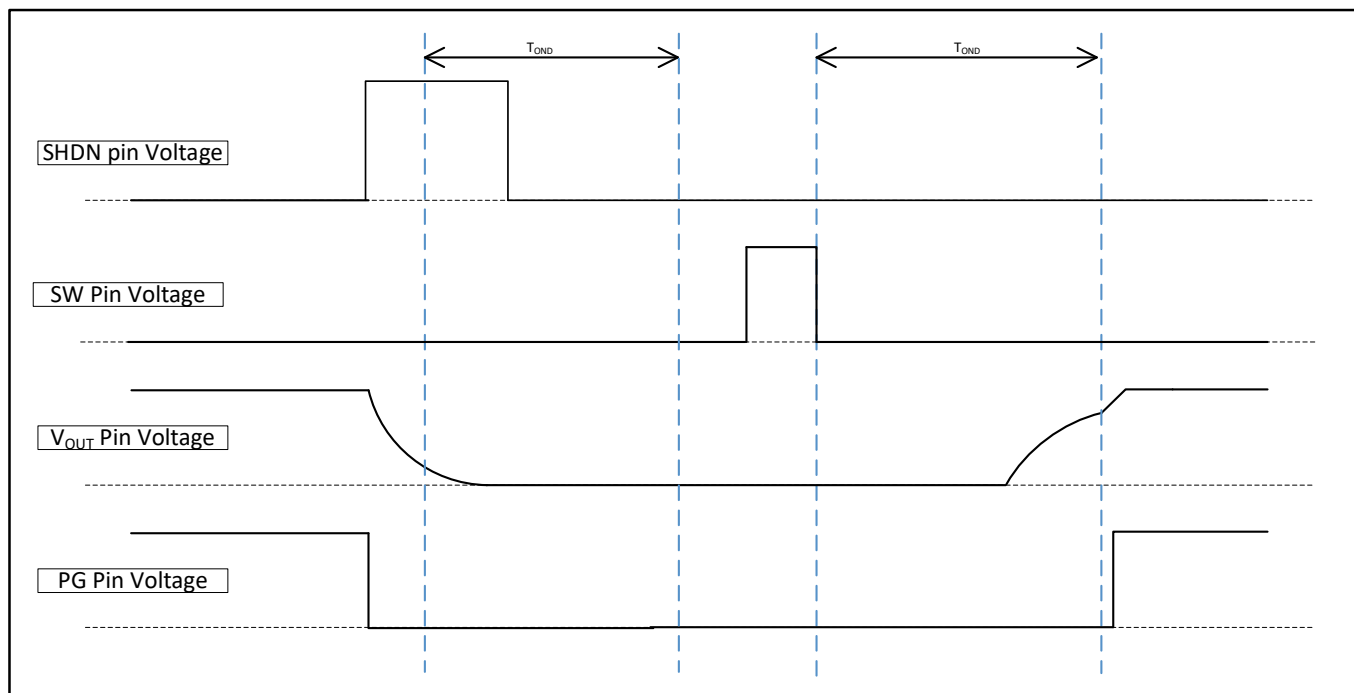

Fig.8 Operation after shutdown.

OPERATIONAL EXPLANATION (Continued)

[Inrush current limit and output short circuit protection: Fig.9]

The XC6192 series has a function that limits rush current and a circuit that shuts down the output when an output short-circuit is detected.

During the time until the V_{OUT} pin voltage reaches V_{RUSH} during the Turn-On sequence, only PM1 turns ON, and therefore the voltage rises through the Pre-driver On Resistor (R_{ONP} : refer to the Electrical Characteristics).

When the V_{OUT} pin voltage reaches V_{RUSH} or more, PM2 turns ON and rush current limiting is released.

The rush current at the instant when PM1 turns ON is calculated using the following equation.

$$\text{Inrush Current} = V_{IN} / R_{ONP} \text{ (A)}$$

In addition, during the time until the V_{OUT} pin voltage reaches V_{RUSH} by means of the rush current limiting function, the load current while V_{OUT} rises must be set to less than the value given by the equation below.

$$\text{Start-up Load Current} < (V_{IN} - V_{RUSH (Max.)}) / R_{ONP} \text{ (A)}$$

Example: $4.2V - 4.15V / 135 \text{ Ohms} = 0.359mA$;

Note this very low 0.359mA is used to charge the output capacitors. If startup load current exceeds this, the output current will pass thru PM1 only, and have a 135 ohm resistor creating a voltage drop. If it's noticed that V_{OUT} is significantly below V_{IN} , please ensure start-up load current is NOT exceeded.

If the V_{OUT} pin voltage drops below the Short Circuit Detect Voltage (V_{SHORT} : refer to the Electrical Characteristics) after the Turn-On sequence, a short-circuit is detected and PM1 and PM2 are latched in the OFF state, causing V_{OUT} to shut down. The relation between the output current (I_{SHORT}) and V_{SHORT} when a short circuit occurs is given by the equation below.

$$I_{SHORT} = (V_{IN} - V_{SHORT}) / R_{ON} \text{ (A)}$$

The equation for the maximum output current is as follows.

$$I_{OUT (Min.)} = (V_{IN} - V_{SHORT (Max.)}) / R_{ON (Max.)} \text{ (A)}$$

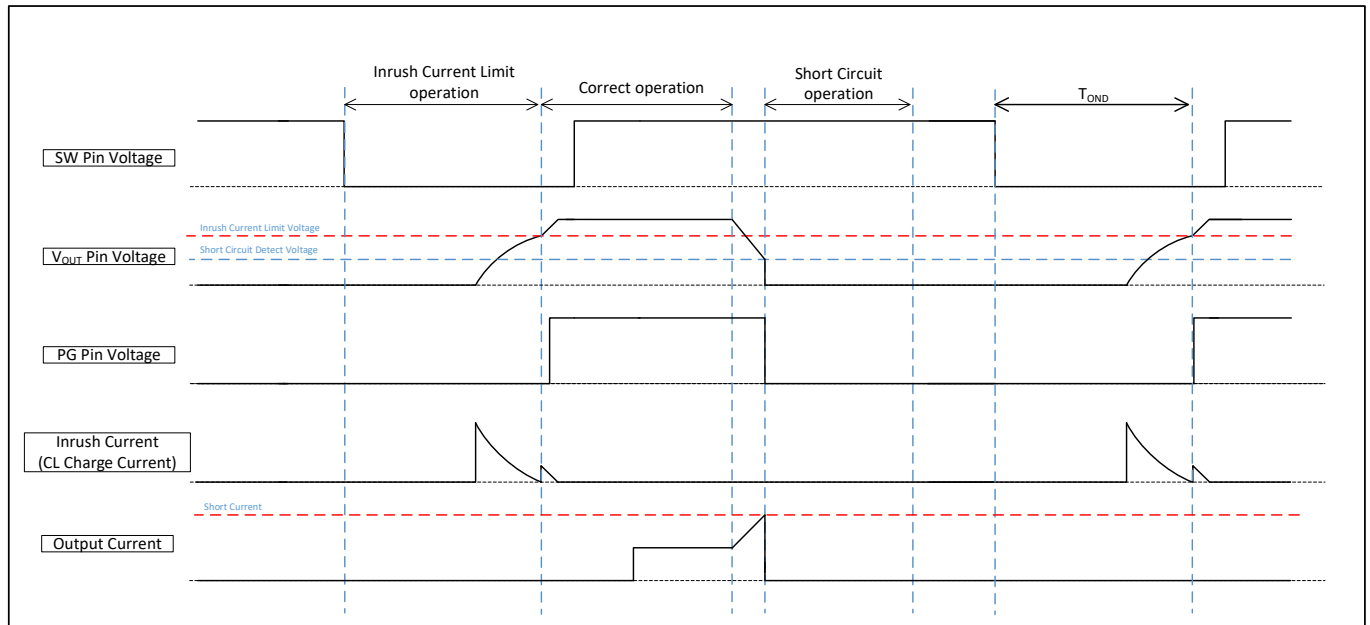

Fig.9 Output capacitor inrush current limit and output short circuit protection

■ OPERATIONAL EXPLANATION (Continued)

[SW pin]

When “L” voltage is input into the SW pin for the duration T_{OND} with the IC in the standby state, the pin fixes V_{OUT} at “H” voltage.

On the A type, when V_{OUT} is fixed at “H” voltage, “L” voltage can be input for the duration T_{OFFD} to shut down V_{OUT} .

[SHDN pin]

This pin shuts down V_{OUT} when one pulse of “H” voltage (1ms or more as a guideline) is input into the SHDN pin with V_{OUT} fixed at “H” voltage.

[PG pin]

NM1 and R2 (Fig.1) are connected to the PG pin.

NM1 is an Nch MOSFET and is synchronized with the GATE signal of PM2, so NM1 turns OFF when PM2 turns ON.

[VOUT pin]

PM1, PM2, and R1 (Fig.1), and R2 (Fig.1) and the CL discharge transistor NM2 (Fig.1) are connected to the output pin.

PM1 is a Pch MOSFET, and is effective in preventing rush current.

PM2 is a Pch MOSFET and functions as the main driver.

NM2 is an Nch MOSFET, and is synchronized with the GATE signal of PM1. Therefore, when PM1 turns ON, NM2 turns OFF.

[SW Circuit]

This circuit transmits the signal input into the SW pin to the internal circuitry.

[SHDN Circuit]

This circuit transmits the signal input into the SHDN pin to the internal circuitry.

[VREF & POR]

This circuit supplies the internal circuit reference voltage and is a reset circuit that is input into the logic circuitry.

[Type Select]

This circuit selects the product type.

[Turn-On Delay Counter]

This circuit count-controls the time until V_{OUT} is fixed at “H” voltage after “L” voltage is input into the SW pin.

During the time until the count is completed, the counter circuit can be returned to the initial state by inputting “H” voltage into the SW pin.

[Turn-Off Delay Counter]

This circuit only operates on the A type.

When V_{OUT} is fixed at “H” voltage, this circuit count-controls the time from input of “L” voltage into the SW pin until V_{OUT} shuts down

During the time until the count is completed, the counter circuit can be returned to the initial state by inputting “H” voltage into the SW pin.

[VREF2 & POR2]

This circuit sets the initial state of the V_{OUT} pin.

The circuit is set so that V_{OUT} is in the shutdown state when the power is turned on, so there is no need to input “H” voltage into the SHDN pin after power is supply to shut down the output.

[Inrush Current Limit]

This circuit limits rush current until the V_{OUT} pin voltage reaches V_{RUSH} .

[Short Circuit Protect]

This circuit outputs a shutdown signal if the V_{OUT} pin voltage reaches V_{SHORT} .

[Gate Slope]

After the V_{OUT} pin voltage reaches V_{RUSH} , this circuit gradually changes the GATE voltage of PM2 from “H” voltage to “L” voltage.

■ NOTES ON USE

- 1) For temporary, transitional voltage drop or voltage rising phenomenon. The IC is liable to malfunction should the ratings be exceeded.
- 2) Please use this IC within the specified operating ranges.
- 3) In some cases, power supply noise may cause malfunctioning of the internal counter circuit. Sufficiently reinforce the V_{IN} , V_{OUT} , and GND lines, and connect $0.1 \mu F$ or higher capacitors near the IC between V_{IN} and GND (V_{SS}), and between V_{OUT} and GND (V_{SS}).
- 4) Turn-On Delay Time characteristics and Turn-Off Delay Time characteristics are increased when using a capacitor larger than $0.1 \mu F$ for CL connected to $V_{OUT} - GND$ (V_{SS}). Sufficiently test actual operation before use.
- 5) When "L" level is input into the SW pin, Operation Current flows. Sufficiently test actual operation before designing peripheral circuits.
- 6) The SW pin and SHDN pin are connected to the gate of a CMOS inverter. If a voltage lower than the V_{IN} pin voltage or a voltage higher than the V_{SS} pin voltage is input into each pin, the flow-through current of the CMOS inverter may appear as supply current.
- 7) If an intermediate voltage between "L" voltage and "H" voltage is input into the SW pin or SHDN pin, starting and stopping of the IC may become unstable. Sufficiently test peripheral components and other parts to ensure that an intermediate voltage between "L" voltage and "H" voltage is not continuously input for an excessive time into the SW pin and SHDN pin.
- 8) The TEST pin must be connected to GND (V_{SS}).
- 9) When using for an application other than a push-button application, please design the timing to include deviations and test sufficiently with the actual device before use.
- 10) The USP-8B06 is a thin surface-mount package. Therefore, distortion of the board during PCB mounting may be transmitted to the IC chip, which may affect Turn-On Delay Time characteristics and Turn-Off Delay Time characteristics. Sufficiently test actual operation before use.
- 11) Torex places an importance on improving our products and their reliability.
We request that users incorporate fail-safe designs and post-aging protection treatment when using Torex products in their systems.

TYPICAL PERFORMANCE CHARACTERISTICS

(1) Standby Current vs. Input Voltage

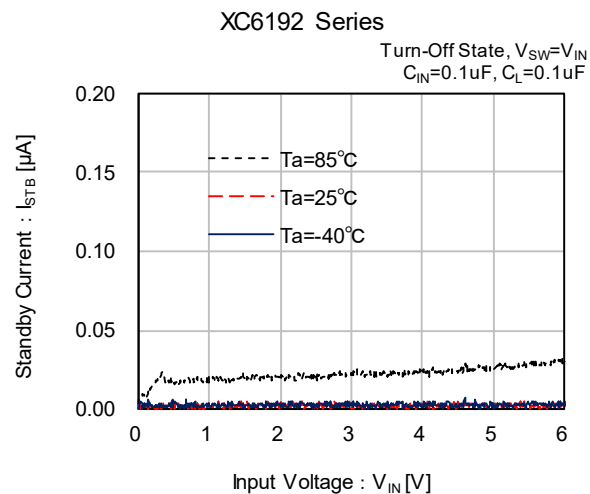

(2) Standby Current vs. Ambient Temperature

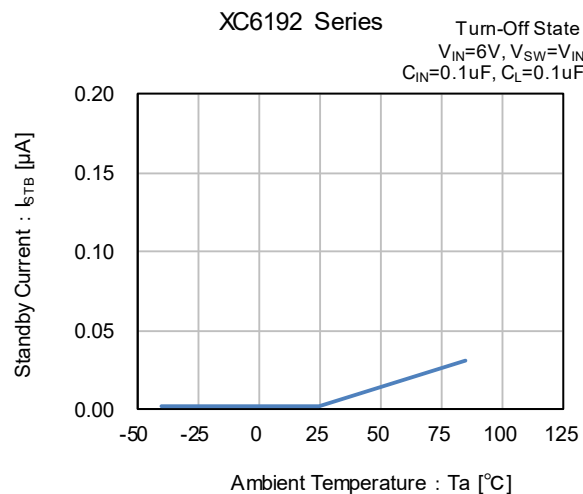

(3) Quiescent Current vs. Input Voltage

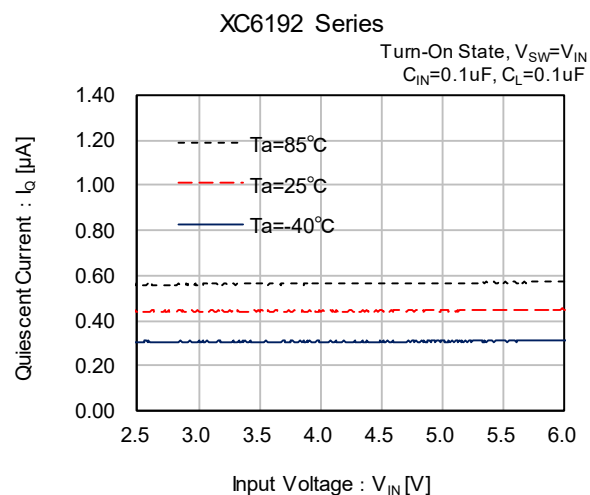

(4) Quiescent Current vs. Ambient Temperature

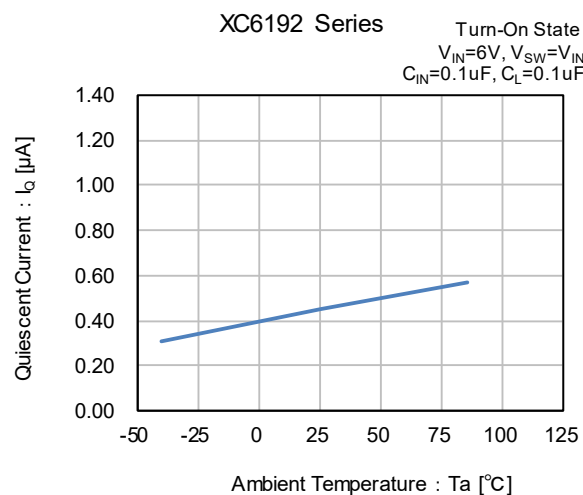

(5) Operation Current vs. Input Voltage

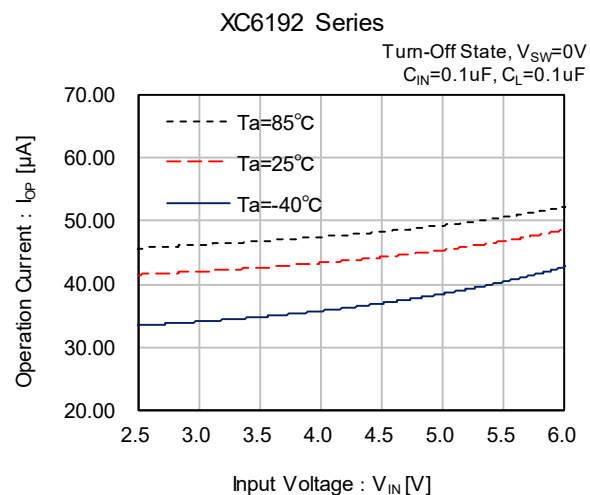

(6) Operation Current vs. Ambient Temperature

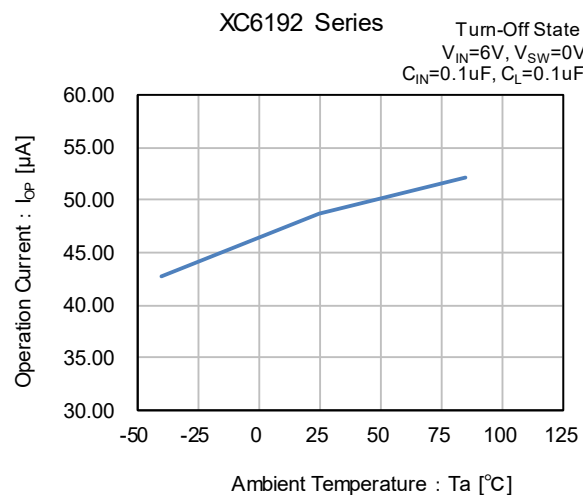

TYPICAL PERFORMANCE CHARACTERISTICS (Continued)

(7) Turn-On Delay Time vs. Ambient Temperature

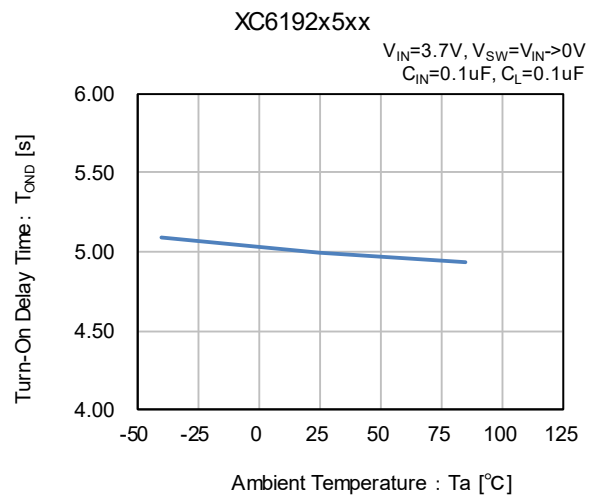
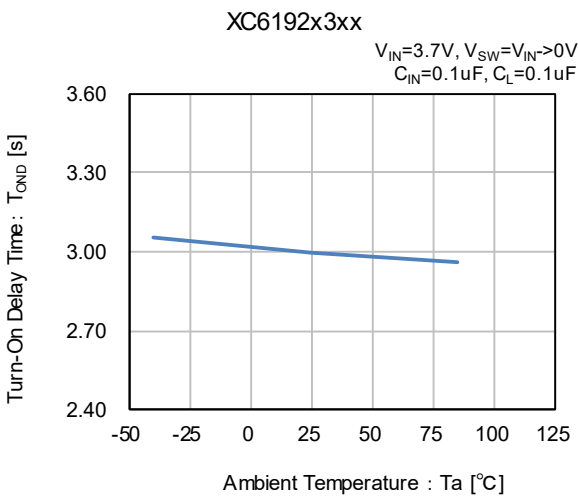
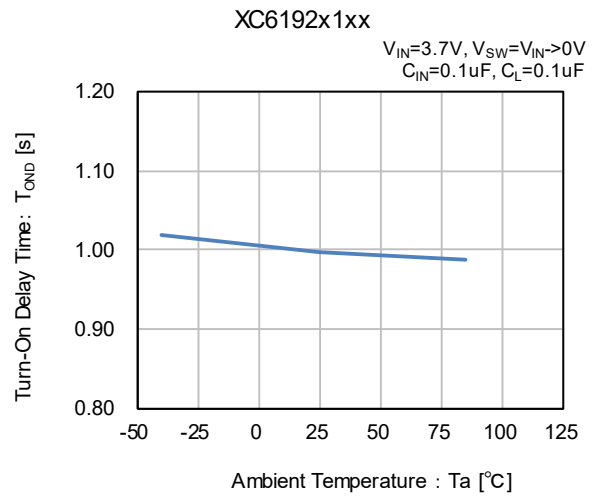
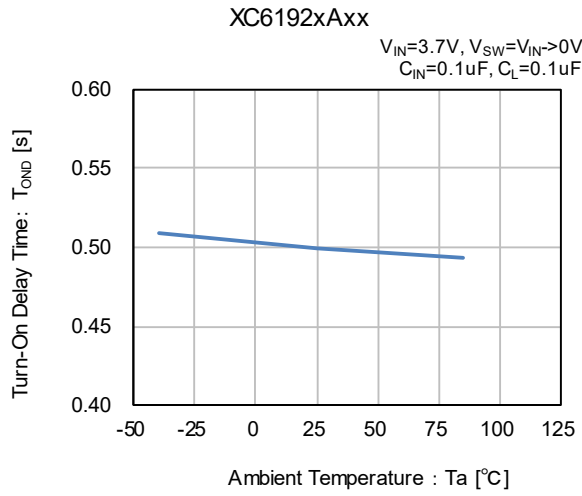

■ TYPICAL PERFORMANCE CHARACTERISTICS (Continued)

(8) Turn-Off Delay Time vs. Ambient Temperature

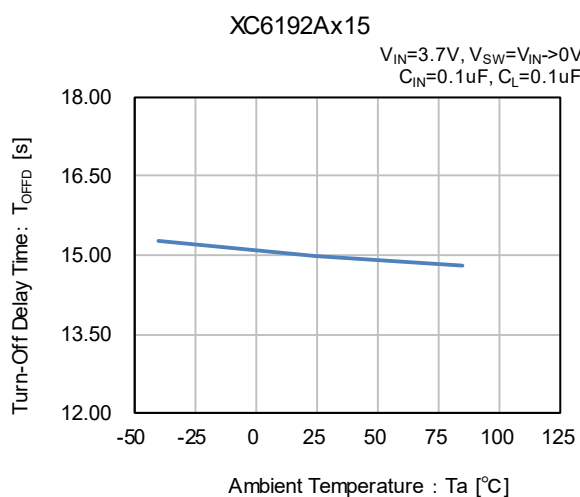
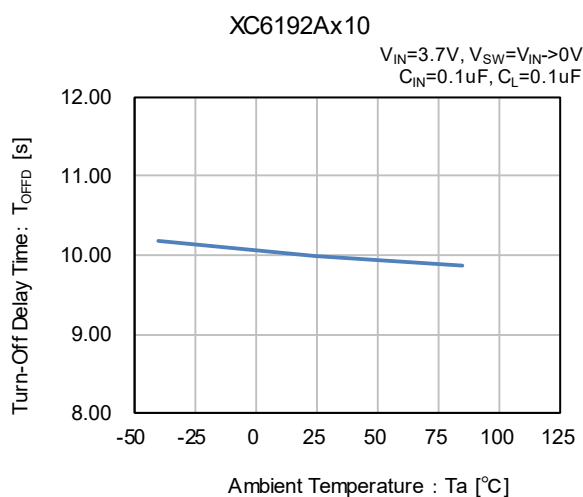
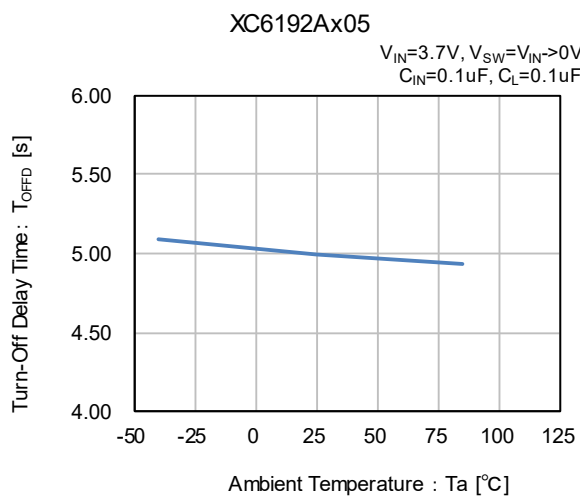
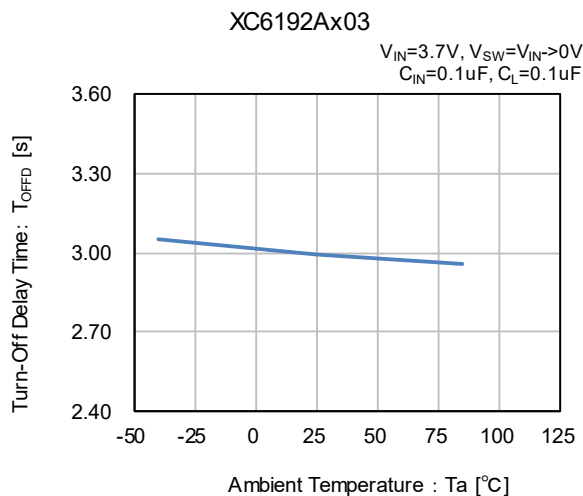

(9) Pre-driver On Resistor vs. Ambient Temperature

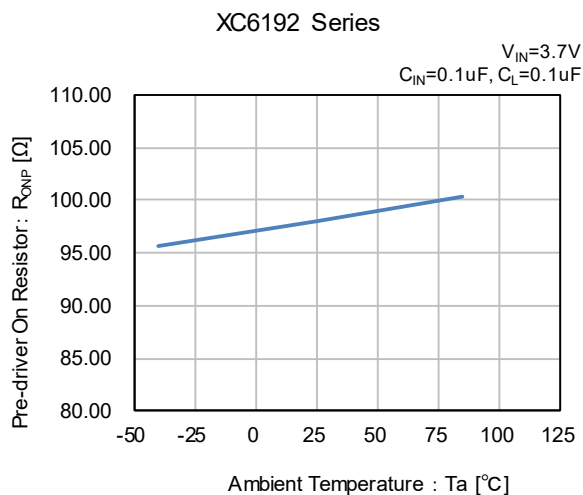

TYPICAL PERFORMANCE CHARACTERISTICS (Continued)

(10) Main driver On Resistor vs. Ambient Temperature

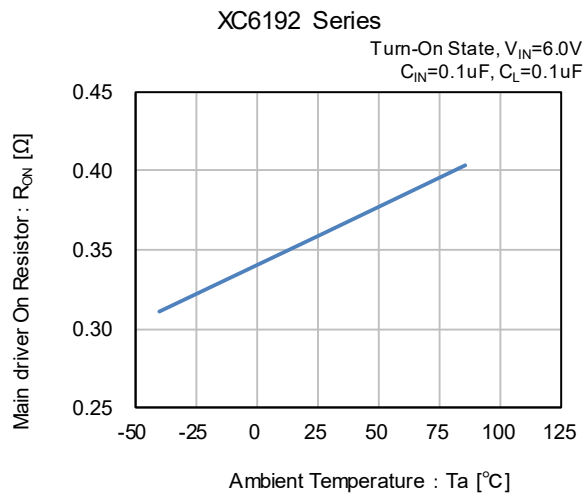
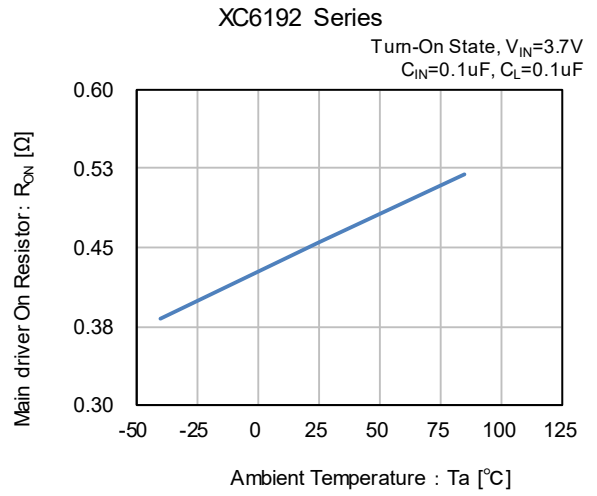
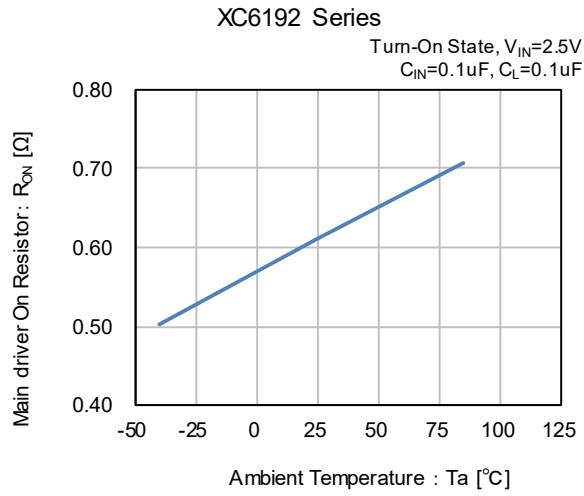

■ TYPICAL PERFORMANCE CHARACTERISTICS (Continued)

(11) SW pin "H" "L" Voltage vs. Ambient Temperature

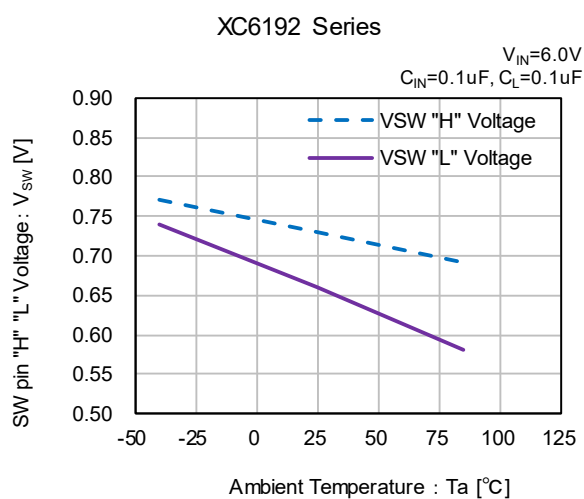
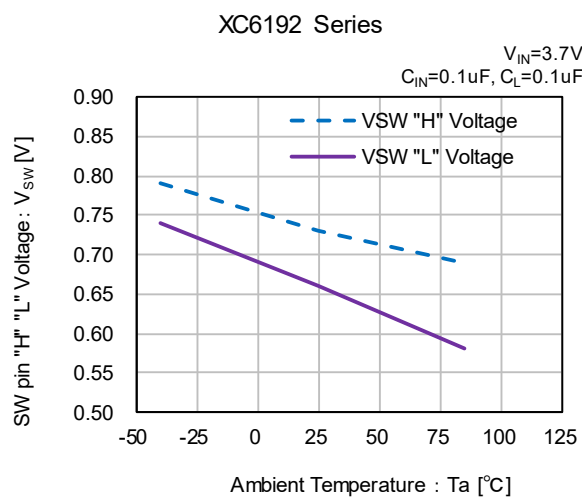
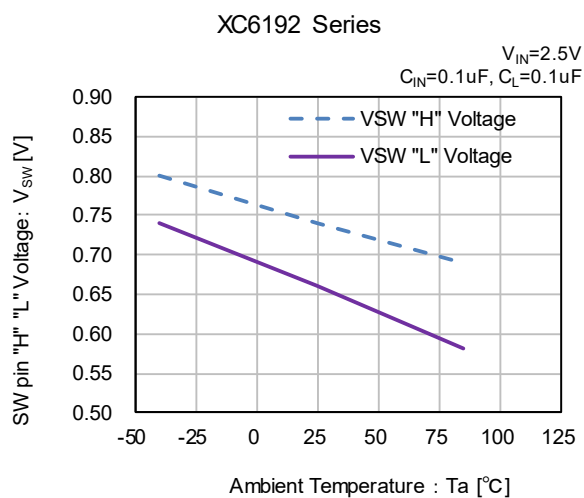

TYPICAL PERFORMANCE CHARACTERISTICS (Continued)

(12) SHDN pin "H" "L" Voltage vs. Ambient Temperature

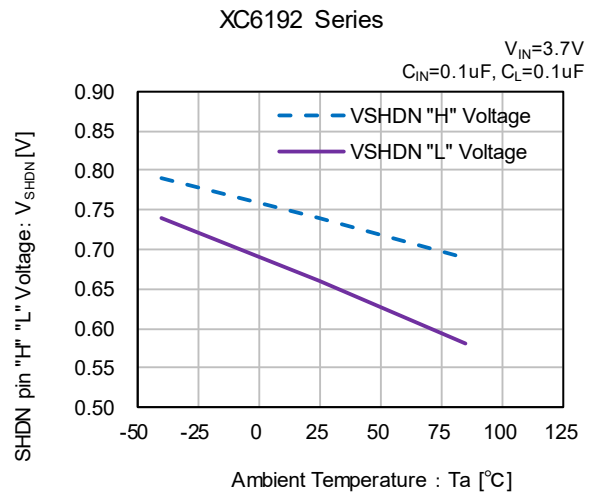
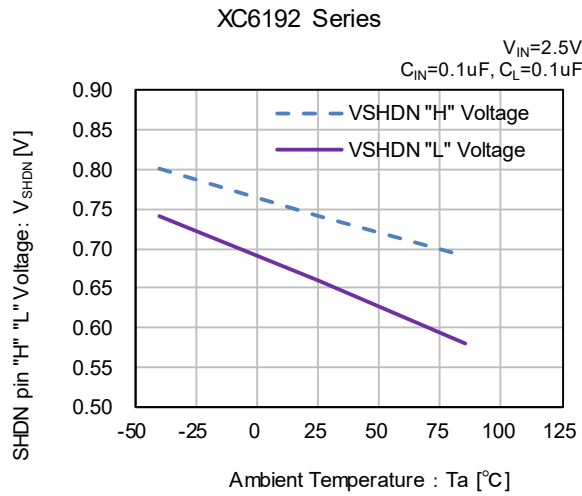

(13) PG pin Output Current vs. Ambient Temperature

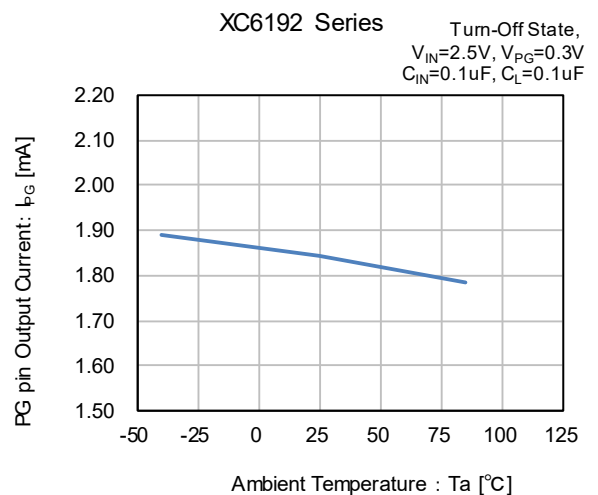
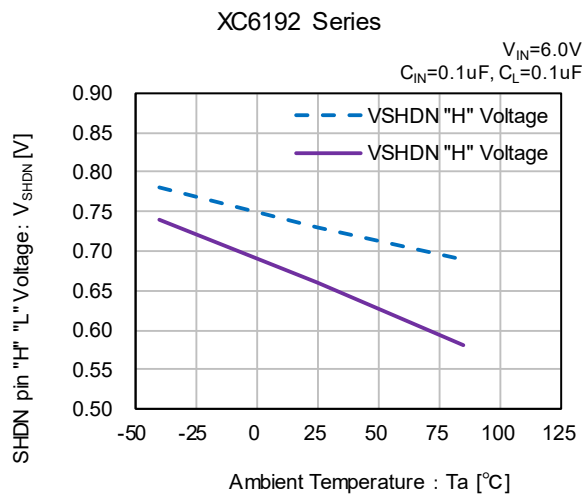

(14) C_L Discharge Current vs. Ambient Temperature

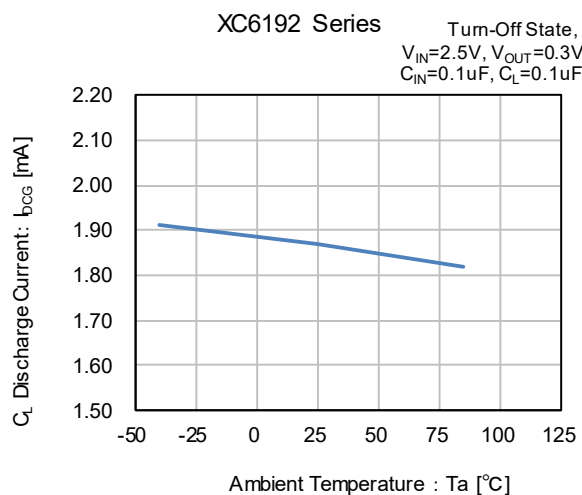

■ PACKAGING INFORMATION

For the latest package information go to, www.torexsemi.com/technical-support/packages

PACKAGE	OUTLINE / LAND PATTERN	THERMAL CHARACTERISTICS	
USP-8B06	USP-8B06 PKG	High heat dissipation Board	USP-8B06 Power Dissipation

MARKING RULE

① represents product series.

MARK	PRODUCT SERIE
2	XC6192*****-G

② represents Type and Turn-On delay time.

MARK	Type	Turn-On delay time	PRODUCT SERIE
0	A	0.5s	XC6192AA****-G
1		1.0s	XC6192A1****-G
2		3.0s	XC6192A3****-G
3		5.0s	XC6192A5****-G
4	B	0.5s	XC6192BA****-G
5		1.0s	XC6192B1****-G
6		3.0s	XC6192B3****-G
7		5.0s	XC6192B5****-G

USP-8B06

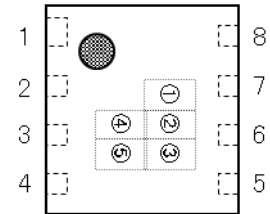

③ represents Turn-Off delay time.

MARK	Turn-Off delay time	PRODUCT SERIE
A	3s	XC6192**03**-G
B	5s	XC6192**05**-G
C	10s	XC6192**10**-G
D	15s	XC6192**15**-G
0	-	XC6192B**NN**-G

④,⑤ represents production lot number

01~09, 0A~0Z, 11~9Z, A1~A9, AA~AZ, B1~ZZ in order.

(G, I, J, O, Q, W excluded)

* No character inversion used.

1. The product and product specifications contained herein are subject to change without notice to improve performance characteristics. Consult us, or our representatives before use, to confirm that the information in this datasheet is up to date.
2. The information in this datasheet is intended to illustrate the operation and characteristics of our products. We neither make warranties or representations with respect to the accuracy or completeness of the information contained in this datasheet nor grant any license to any intellectual property rights of ours or any third party concerning with the information in this datasheet.
3. Applicable export control laws and regulations should be complied and the procedures required by such laws and regulations should also be followed, when the product or any information contained in this datasheet is exported.
4. The product is neither intended nor warranted for use in equipment of systems which require extremely high levels of quality and/or reliability and/or a malfunction or failure which may cause loss of human life, bodily injury, serious property damage including but not limited to devices or equipment used in 1) nuclear facilities, 2) aerospace industry, 3) medical facilities, 4) automobile industry and other transportation industry and 5) safety devices and safety equipment to control combustions and explosions. Do not use the product for the above use unless agreed by us in writing in advance.
5. Although we make continuous efforts to improve the quality and reliability of our products; nevertheless Semiconductors are likely to fail with a certain probability. So in order to prevent personal injury and/or property damage resulting from such failure, customers are required to incorporate adequate safety measures in their designs, such as system fail safes, redundancy and fire prevention features.
6. Our products are not designed to be Radiation-resistant.
7. Please use the product listed in this datasheet within the specified ranges.
8. We assume no responsibility for damage or loss due to abnormal use.
9. All rights reserved. No part of this datasheet may be copied or reproduced unless agreed by Torex Semiconductor Ltd in writing in advance.

TOREX SEMICONDUCTOR LTD.