

# High Voltage IGBT with optional Diode

**IXDH 20N120**  
**IXDH 20N120 D1**

$V_{CES} = 1200\text{ V}$   
 $I_{C25} = 38\text{ A}$   
 $V_{CE(sat) typ} = 2.4\text{ V}$

Short Circuit SOA Capability  
Square RBSOA

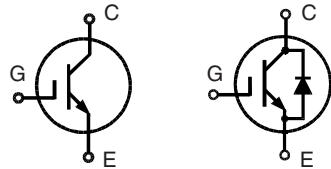

IXDH 20N120 IXDH 20N120 D1

**TO-247 AD**

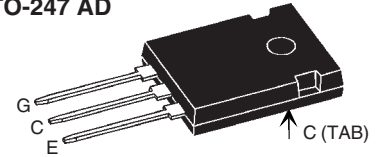

G = Gate,  
C = Collector ,  
E = Emitter  
TAB = Collector

Symbol	Conditions	Maximum Ratings	
$V_{CES}$	$T_J = 25^\circ\text{C}$ to $150^\circ\text{C}$	1200	V
$V_{CGR}$	$T_J = 25^\circ\text{C}$ to $150^\circ\text{C}$ ; $R_{GE} = 20\text{ k}\Omega$	1200	V
$V_{GES}$	Continuous	$\pm 20$	V
$V_{GEM}$	Transient	$\pm 30$	V
$I_{C25}$	$T_C = 25^\circ\text{C}$	38	A
$I_{C90}$	$T_C = 90^\circ\text{C}$	25	A
$I_{CM}$	$T_C = 90^\circ\text{C}$ , $t_p = 1\text{ ms}$	50	A
<b>RBSOA</b>	$V_{GE} = \pm 15\text{ V}$ , $T_J = 125^\circ\text{C}$ , $R_G = 82\ \Omega$ Clamped inductive load, $L = 30\ \mu\text{H}$	$I_{CM} = 35$ $V_{CEK} < V_{CES}$	A
$t_{SC}$ <b>(SCSOA)</b>	$V_{GE} = \pm 15\text{ V}$ , $V_{CE} = V_{CES}$ , $T_J = 125^\circ\text{C}$ $R_G = 82\ \Omega$ , non repetitive	10	$\mu\text{s}$
$P_C$	$T_C = 25^\circ\text{C}$	IGBT	200 W
		Diode	75 W
$T_J$		-55 ... +150	$^\circ\text{C}$
$T_{stg}$		-40 < ... +150	$^\circ\text{C}$
	Maximum lead temperature for soldering 1.6 mm (0.062 in.) from case for 10 s	300	$^\circ\text{C}$
$M_d$	Mounting torque	0.8 - 1.2	Nm
<b>Weight</b>		6	g

## Features

- NPT IGBT technology
- low saturation voltage
- low switching losses
- square RBSOA, no latch up
- high short circuit capability
- positive temperature coefficient for easy paralleling
- MOS input, voltage controlled
- optional ultra fast diode
- International standard package

## Advantages

- Space savings
- High power density

## Typical Applications

- AC motor speed control
- DC servo and robot drives
- DC choppers
- Uninterruptible power supplies (UPS)
- Switch-mode and resonant-mode power supplies

Symbol	Conditions	Characteristic Values ( $T_J = 25^\circ\text{C}$ , unless otherwise specified)		
		min.	typ.	max.
$V_{(BR)CES}$	$V_{GE} = 0\text{ V}$	1200		V
$V_{GE(th)}$	$I_C = 0.6\text{ mA}$ , $V_{CE} = V_{GE}$	4.5		6.5 V
$I_{CES}$	$V_{CE} = V_{CES}$	$T_J = 25^\circ\text{C}$		1 mA
		$T_J = 125^\circ\text{C}$	2	1 mA
$I_{GES}$	$V_{CE} = 0\text{ V}$ , $V_{GE} = \pm 20\text{ V}$			$\pm 500\text{ nA}$
$V_{CE(sat)}$	$I_C = 20\text{ A}$ , $V_{GE} = 15\text{ V}$	2.4	3	V

Symbol	Conditions	Characteristic Values		
		(T <sub>J</sub> = 25°C, unless otherwise specified)		
		min.	typ.	max.
C <sub>ies</sub>	V <sub>CE</sub> = 25 V, V <sub>GE</sub> = 0 V, f = 1 MHz		1000	pF
C <sub>oes</sub>			150	pF
C <sub>res</sub>			70	pF
Q <sub>g</sub>	I <sub>C</sub> = 20 A, V <sub>GE</sub> = 15 V, V <sub>CE</sub> = 0.5 V <sub>CES</sub>		70	nC
t <sub>d(on)</sub>	Inductive load, T <sub>J</sub> = 125°C I <sub>C</sub> = 20 A, V <sub>GE</sub> = ±15 V, V <sub>CE</sub> = 600 V, R <sub>G</sub> = 82 Ω		100	ns
t <sub>r</sub>			75	ns
t <sub>d(off)</sub>			500	ns
t <sub>f</sub>			70	ns
E <sub>on</sub>			3.1	mJ
E <sub>off</sub>			2.4	mJ
R <sub>thJC</sub>				0.63 K/W
R <sub>thCH</sub>	Package with heatsink compound	0.25		K/W

Reverse Diode (FRED) [D1 version only]		Characteristic Values		
		(T <sub>J</sub> = 25°C, unless otherwise specified)		
Symbol	Conditions	min.	typ.	max.
V <sub>F</sub>	I <sub>F</sub> = 20 A, V <sub>GE</sub> = 0 V		2.6	2.9 V
	I <sub>F</sub> = 20 A, V <sub>GE</sub> = 0 V, T <sub>J</sub> = 125°C		2.1	V
I <sub>F</sub>	T <sub>C</sub> = 25°C			31 A
	T <sub>C</sub> = 90°C			19 A
I <sub>RM</sub>	I <sub>F</sub> = 20 A, -di <sub>F</sub> /dt = 400 A/μs, V <sub>R</sub> = 600 V		15	A
t <sub>rr</sub>	V <sub>GE</sub> = 0 V, T <sub>J</sub> = 125°C		200	ns
t <sub>rr</sub>	I <sub>F</sub> = 1 A, -di <sub>F</sub> /dt = 100 A/μs, V <sub>R</sub> = 30 V, V <sub>GE</sub> = 0 V		40	ns
R <sub>thJC</sub>				1.6 K/W

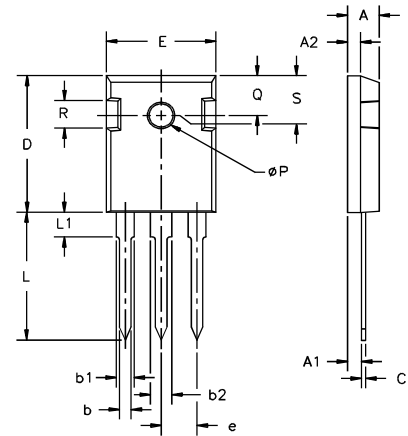
**TO-247 AD Outline**

Dim.	Millimeter		Inches	
	Min.	Max.	Min.	Max.
A	4.7	5.3	.185	.209
A <sub>1</sub>	2.2	2.54	.087	.102
A <sub>2</sub>	2.2	2.6	.059	.098
b	1.0	1.4	.040	.055
b <sub>1</sub>	1.65	2.13	.065	.084
b <sub>2</sub>	2.87	3.12	.113	.123
C	.4	.8	.016	.031
D	20.80	21.46	.819	.845
E	15.75	16.26	.610	.640
e	5.20	5.72	0.205	0.225
L	19.81	20.32	.780	.800
L1		4.50		.177
∅P	3.55	3.65	.140	.144
Q	5.89	6.40	0.232	0.252
R	4.32	5.49	.170	.216
S	6.15	BSC	242	BSC

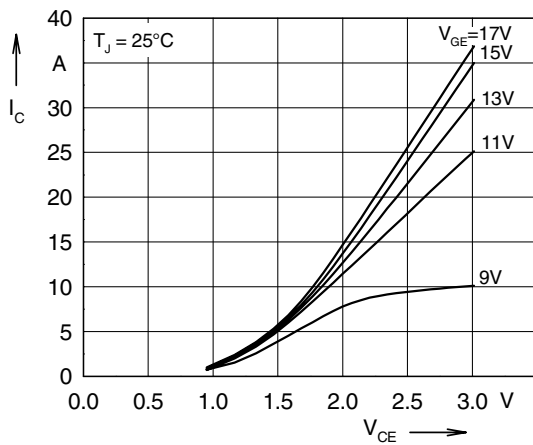

Fig. 1 Typ. output characteristics

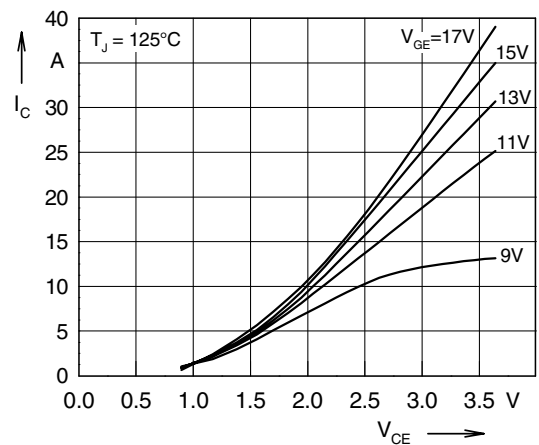

Fig. 2 Typ. output characteristics

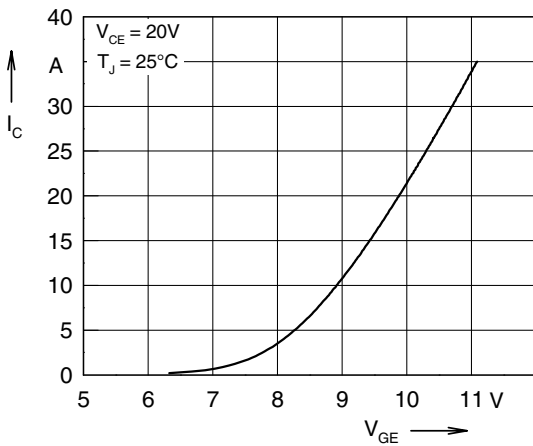

Fig. 3 Typ. transfer characteristics

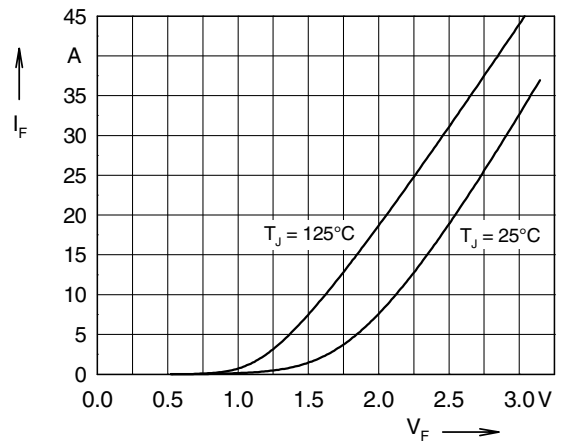

Fig. 4 Typ. forward characteristics of free wheeling diode (D1 version only)

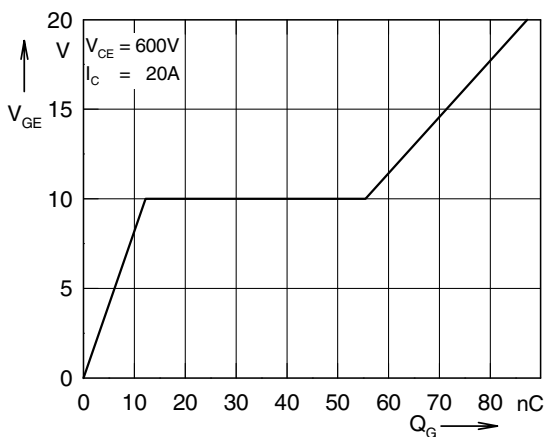

Fig. 5 Typ. turn on gate charge

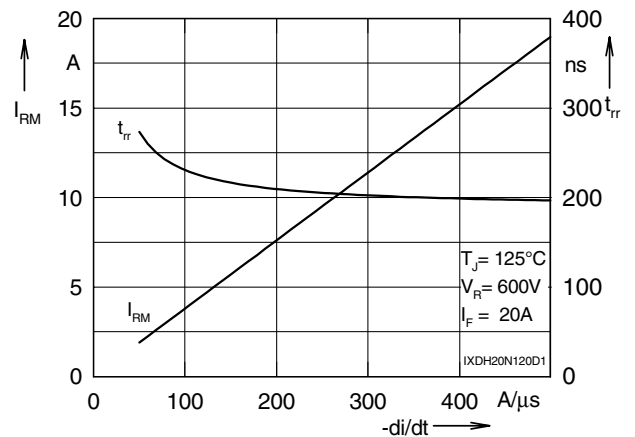

Fig. 6 Typ. turn off characteristics of free wheeling diode (D1 version only)

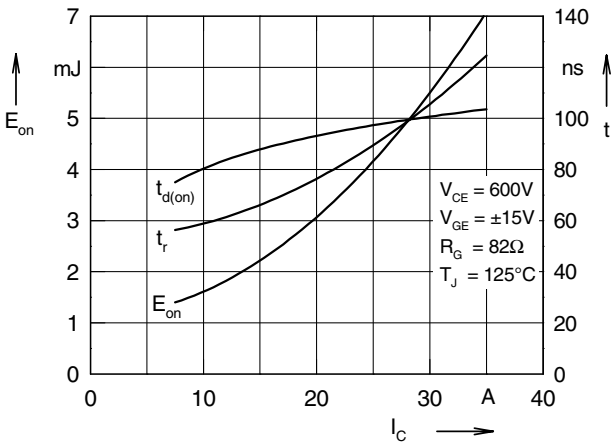

Fig. 7 Typ. turn on energy and switching times versus collector current

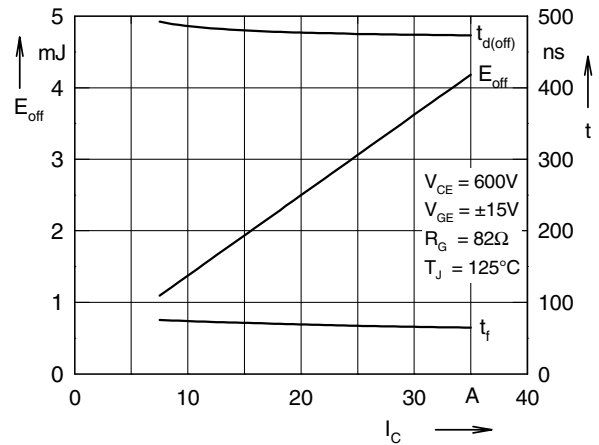

Fig. 8 Typ. turn off energy and switching times versus collector current

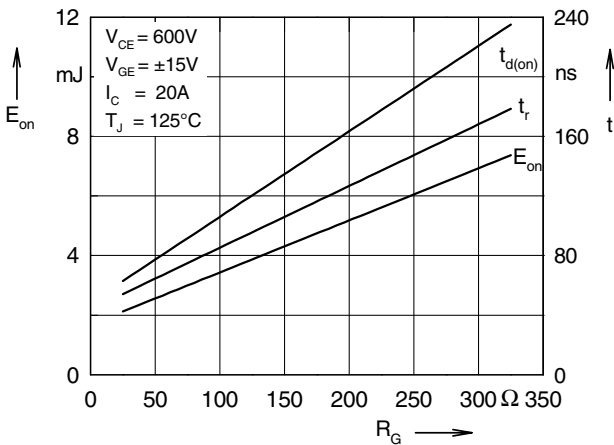

Fig. 9 Typ. turn on energy and switching times versus gate resistor

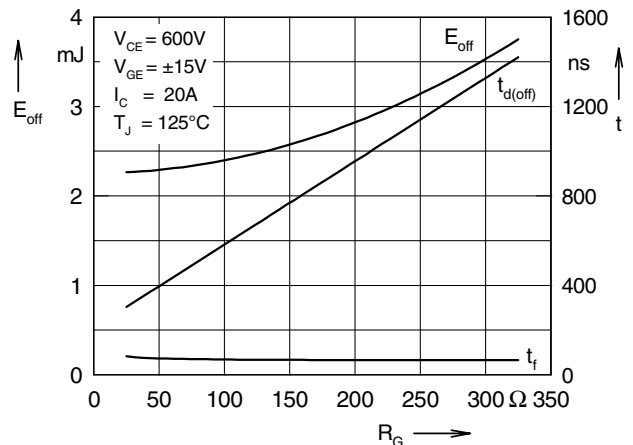

Fig.10 Typ. turn off energy and switching times versus gate resistor

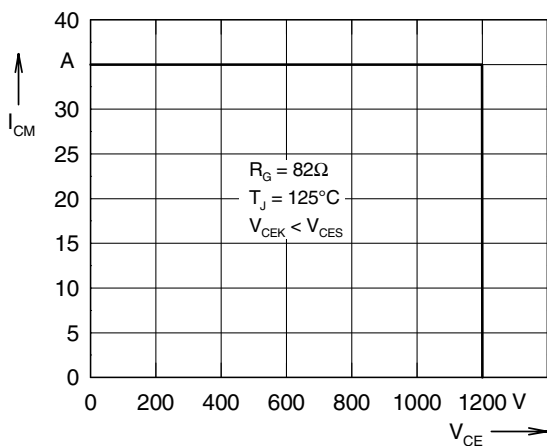

Fig. 11 Reverse biased safe operating area RBSOA

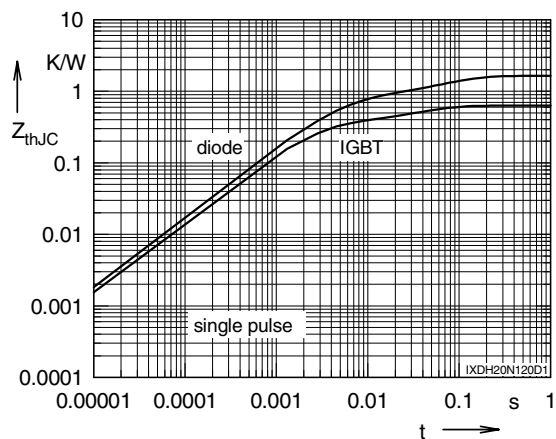

Fig. 12 Typ. transient thermal impedance



---

Disclaimer Notice - Information furnished is believed to be accurate and reliable. However, users should independently evaluate the suitability of and test each product selected for their own applications. Littelfuse products are not designed for, and may not be used in, all applications. Read complete Disclaimer Notice at [www.littelfuse.com/disclaimer-electronics](http://www.littelfuse.com/disclaimer-electronics).