

1.2 A, 30 V Step-Down DC/DC Converter

No. EA-269-201022

OUTLINE

The R1245x is a CMOS-based Step-down DC/DC converter with internal N-channel high side Tr. The ON resistance of the built-in high-side transistor is 0.35Ω and the R1245x can provide the maximum 1.2 A output current. Each of the ICs consists of an oscillator, a PWM control circuit, a voltage reference unit, an error amplifier, a phase compensation circuit, a slope compensation circuit, a soft-start circuit, protection circuits, an internal voltage regulator, and a switch for bootstrap circuit. The ICs can make up a step-down DC/DC converter with an inductor, resistors, a diode, and capacitors.

The R1245x is a current mode operating type DC/DC converter without an external current sense resistor, and realizes fast response and high efficiency. As an output capacitor, a ceramic type capacitor can be used with the R1245x. The options of the internal oscillator frequency are preset at 330 kHz for version A and B, 500 kHz for version C and D, 1000 kHz for version E and F, 2400 kHz for version G and H.

As for protection, an Lx peak current limit circuit cycle by cycle, a thermal shutdown function and an under voltage lockout (UVLO) function are built in. Furthermore, there are two types for short protection, for A/C/E/G version, a latch protection function which makes the output latch off if the output voltage keeps lower than the set output voltage for a certain time after detecting current limit is built in, for B/D/F/H version, a fold-back protection function which changes the oscillator frequency slower after detecting short circuit or equivalent.

As for the packages of the R1245x, HSOP-8E, DFN(PL)2020-8, SOT23-6W are available.

FEATURES

- Operating Voltage 4.5 V to 30 V
- Internal N-channel MOSFET Driver Typ. $R_{ON} = 0.35 \Omega$
- Adjustable Output Voltage with External Resistor 0.8 V or more
- Feedback Voltage and Tolerance $0.8 V \pm 1.0\%$
- Peak Current Limit Typ. 2.0 A
- UVLO Function Released Voltage Typ. 4.0 V
- Operating Frequency 330 kHz (Ver. A/B), 500 kHz (Ver. C/D),
1000 kHz (Ver. E/F), 2400 kHz (Ver. G/H)
- Fold-back Protected Frequency 170 kHz (Ver. B/D), 250 kHz (Ver. F), 400 kHz (Ver. H)
- Latch Protection Delay Time Typ. 4 ms (Ver. A/C/E/G)
- Ceramic Capacitors Recommended for Input and Output.
- Stand-by Current Typ. 0 μ A
- Packages SOT-23-6W, DFN(PL)2020-8, HSOP-8E

R1245x

No. EA-269-201022

APPLICATIONS

- Digital Home Appliances: Digital TVs, DVD Players
- Office Equipment: Printers, Faxes
- 5V PSU or 2-cell or more Li-ion Battery Powered Communication Equipment, Cameras, VCRs, Camcorders
- High Voltage Battery-powered Equipment

SELECTION GUIDE

In the R1245x, the package, type of short protection (Latch or Fold-back), and the oscillator frequency can be selected with the user's request.

Selection Guide

Product code	Package	Quantity per Reel	Pb Free	Halogen Free
R1245S003*-E2-FE	HSOP-8E	1,000 pcs	Yes	Yes
R1245K003*-TR	DFN(PL)2020-8	5,000 pcs	Yes	Yes
R1245N001*-TR-FE	SOT-23-6W	3,000 pcs	Yes	Yes

*: Designation of the oscillator frequency and the protection function option.

Symbol	Oscillator Frequency	Latch Protection	Fold-back Protection
A	330 kHz	✓	
B	330 kHz		✓
C	500 kHz	✓	
D	500 kHz		✓
E	1000 kHz	✓	
F	1000 kHz		✓
G	2400 kHz	✓	
H	2400 kHz		✓

BLOCK DIAGRAM

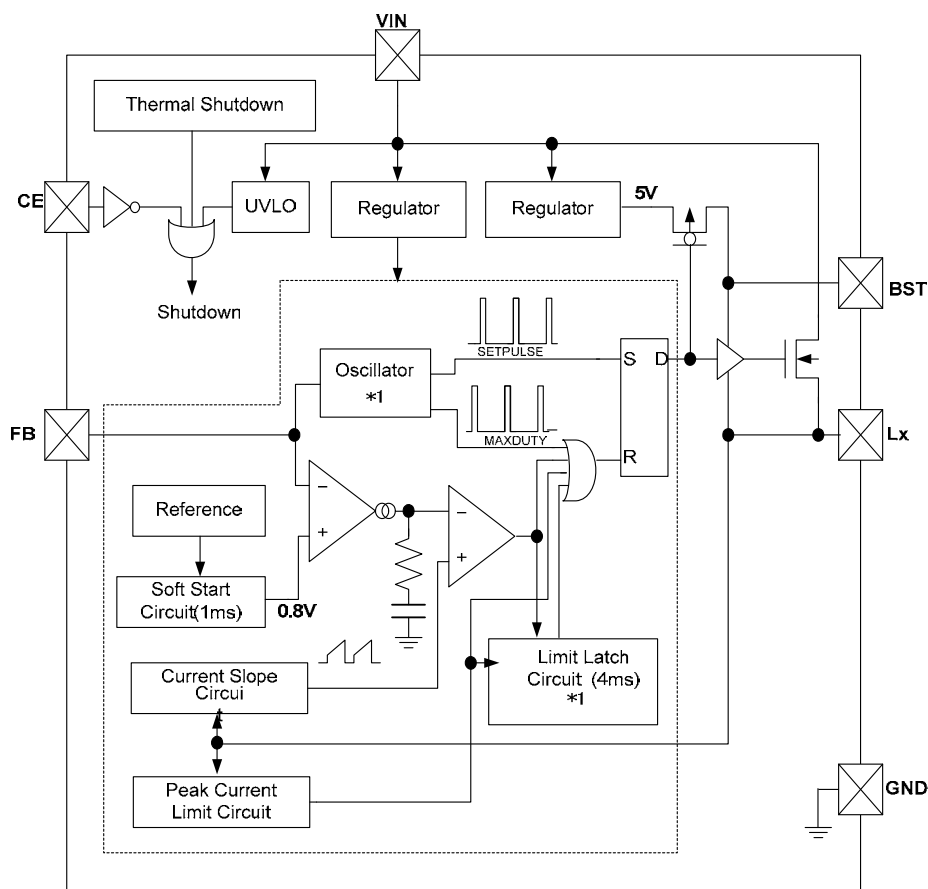

R1245x Block Diagram

*1

Version	Oscillator Frequency	Short Protection Type
A	330 kHz	330 kHz
B	330 kHz	330 kHz
C	500 kHz	500 kHz
D	500 kHz	500 kHz
E	1000 kHz	1000 kHz
F	1000 kHz	1000 kHz
G	2400 kHz	2400 kHz
H	2400 kHz	2400 kHz

PIN DESCRIPTIONS

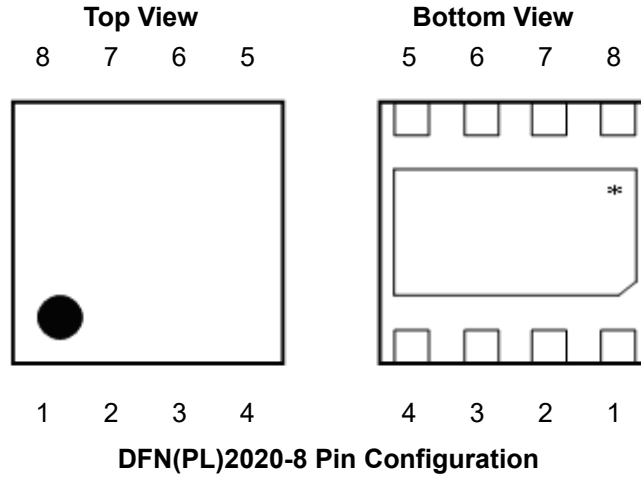

DFN(PL)2020-8 Pin Configuration

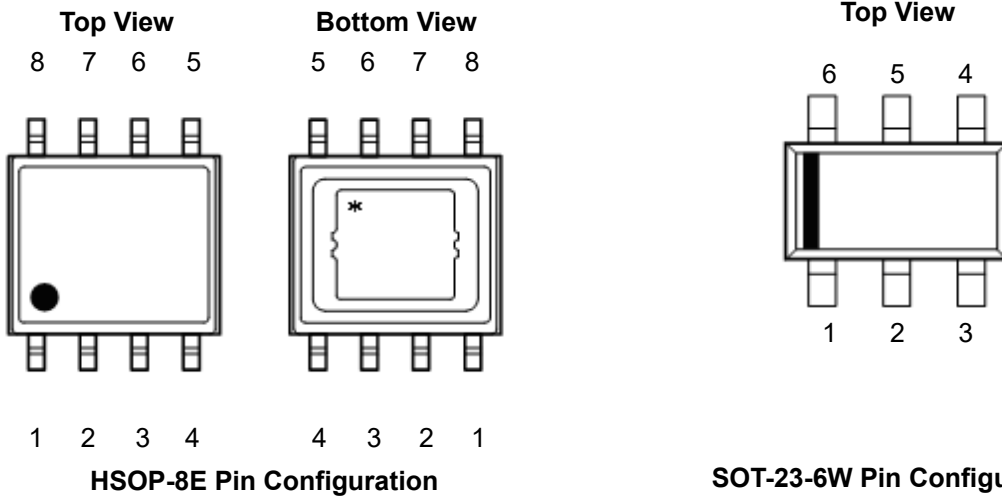

HSOP-8E Pin Configuration

SOT-23-6W Pin Configuration

* Connect the backside heat radiation tub to GND or same as GND level (recommendation). The tub is connected to the GND pin.

R1245S Pin Description

Pin No.	Symbol	Description
1	Lx	Lx Switching Pin
2	VIN	Power Supply Pin
3	CE	Chip Enable Pin, Active with "H"
4	TEST	TEST pin (must be open for user side.)
5	GND	Ground Pin
6	FB	Feedback Pin
7	NC	No connection
8	BST	Bootstrap Pin

* Connect the backside heat radiation tub to GND or same as GND level (recommendation). The tub is connected to the GND pin.

R1245K Pin Description

Pin No.	Symbol	Description
1	Lx	Lx Switching Pin
2	VIN	Power Supply Pin
3	VIN	Power Supply Pin
4	CE	Chip Enable Pin, Active with "H"
5	GND	Ground Pin
6	FB	Feedback Pin
7	TEST	Test Pin (must be open for user side.)
8	BST	Bootstrap Pin

* Connect the backside heat radiation tub to GND or same as GND level (recommendation). The tub is connected to the GND pin.

R1245N Pin Description

Pin No.	Symbol	Description
1	BST	Bootstrap Pin
2	GND	Ground Pin
3	FB	Feedback Pin
4	CE	Chip Enable Pin, Active with "H"
5	VIN	Power Supply Pin
6	Lx	Lx Switching Pin

INTERNAL EQUIVALENT CIRCUIT FOR EACH PIN

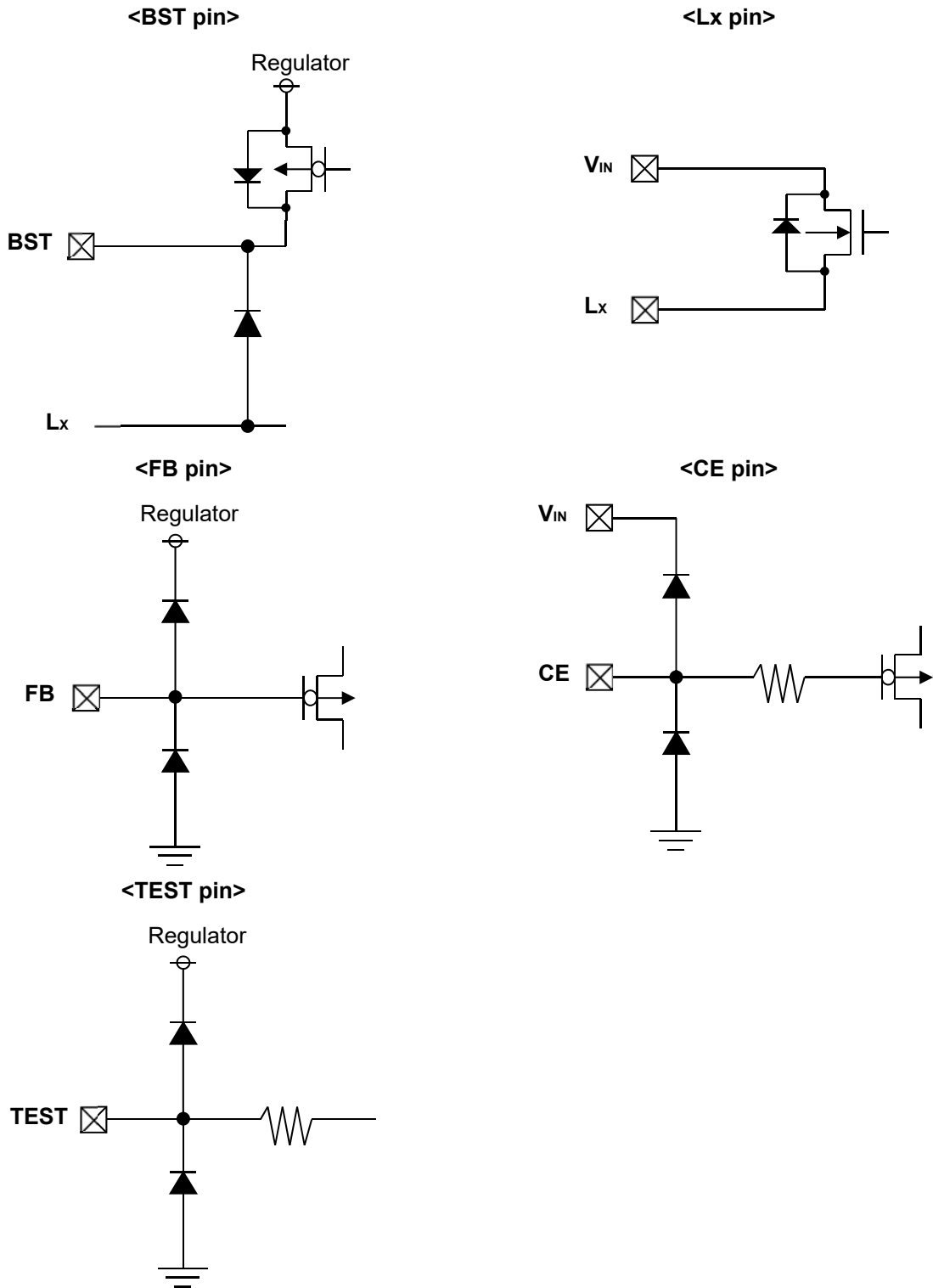

ABSOLUTE MAXIMUM RATINGS

Absolute Maximum Ratings

(GND = 0 V)

Symbol	Item		Rating	Unit	
V _{IN}	Input Voltage		-0.3 V to 32 V	V	
V _{BST}	BST Pin Voltage		V _{LX} - 0.3 V to V _{LX} + 6 V	V	
V _{LX}	Lx Pin Voltage		-0.3 V to V _{IN} + 0.3	V	
V _{CE}	CE Pin Input Voltage		-0.3 V to V _{IN} + 0.3	V	
V _{FB}	Feedback Pin Voltage		-0.3 V to 6 V	V	
P _D	Power Dissipation*	HSOP-8E	Ultra High Wattage Land Pattern	2900	mW
		DFN(PL)2020-8	Standard Land Pattern	880	
		SOT-23-6W	Standard Land Pattern	430	
T _j	Junction Temperature Range		-40 to 125	°C	
T _{stg}	Storage Temperature Range		-55 to 125	°C	

* Refer to *POWER DISSIPATION* for detailed information.

ABSOLUTE MAXIMUM RATINGS

Electronic and mechanical stress momentarily exceeded absolute maximum ratings may cause the permanent damages and may degrade the lifetime and safety for both device and system using the device in the field. The functional operation at or over these absolute maximum ratings is not assured.

RECOMMENDED OPERATING CONDITIONS

Recommended Operating Conditions

Symbol	Item	Rating	Unit
V _{IN}	Operating Input Voltage	4.5 to 30	V
T _a	Operating Temperature Range	-40 to 105	°C

RECOMMENDED OPERATING CONDITIONS

All of electronic equipment should be designed that the mounted semiconductor devices operate within the recommended operating conditions. The semiconductor devices cannot operate normally over the recommended operating conditions, even if when they are used over such conditions by momentary electronic noise or surge. And the semiconductor devices may receive serious damage when they continue to operate over the recommended operating conditions.

R1245x

No. EA-269-201022

ELECTRICAL CHARACTERISTICS**Electrical Characteristics**(Unless otherwise noted, $V_{IN} = 12\text{ V}$, $T_a = 25^\circ\text{C}$)

Symbol	Item	Conditions	Min.	Typ.	Max.	Unit
I_{IN}	Consumption Current	$V_{IN} = 30\text{ V}$, $V_{FB} = 1.0\text{ V}$		0.5	1.0	mA
V_{UVLO1}	UVLO Detect Voltage	Specified V_{IN} falling edge	3.6	V_{UVLO2} -0.2	V_{UVLO2} -0.1	V
V_{UVLO2}	UVLO Released Voltage	Specified rising edge	3.8	4.0	4.2	V
V_{FB}	VFB Voltage Tolerance		0.792	0.800	0.808	V
$\Delta V_{FB}/\Delta T_a$	VFB Voltage Temperature Coefficient	$-40^\circ\text{C} \leq T_a \leq 105^\circ\text{C}$		± 100		ppm/ °C
f_{osc}	Oscillator Frequency	Ver. A/B	300	330	360	kHz
		Ver. C/D	450	500	550	
		Ver. E/F	900	1000	1100	
		Ver. G/H	2200	2400	2600	
f_{FLB}	Fold back Frequency	$V_{FB} < 0.56\text{ V}$	Ver. B/D		170	kHz
			Ver. F		250	
			Ver. H		400	
Maxduty	Oscillator Maximum Duty Cycle	Ver. A/B/C/D	92			%
		Ver. E/F	88			
		Ver. G/H	76			
t_{start}	Soft-start Time	$V_{FB} = 0.72\text{ V}$		1		ms
t_{DLY}	Delay Time for Latch Protection	Ver. A/C/E/G		4		ms
R_{LXH}	Lx High Side Switch ON Resistance	$V_{BST} - V_{LX} = 4.5\text{ V}$		0.35		Ω
I_{LXHOFF}	Lx High Side Switch Leakage Current	$V_{IN} = 30\text{ V}$, $V_{CE} = 0\text{ V}$		0	5	μA
I_{LIMLXH}	Lx High Side Switch Limited Current	$V_{BST} - V_{LX} = 4.5\text{ V}$	1.5	2.0	2.7	A
V_{CEL}	CE "L" Input Voltage	$V_{IN} = 30\text{ V}$			0.3	V
V_{CEH}	CE "H" Input Voltage	$V_{IN} = 30\text{ V}$	1.6			V
I_{FB}	VFB Input Current	$V_{IN} = 30.0\text{ V}$, $V_{FB} = 1.0\text{ V}$	-1.0		1.0	μA
I_{CEL}	CE "L" Input Current	$V_{IN} = 30\text{ V}$, $V_{CE} = 0\text{ V}$	-1.0		1.0	μA
I_{CEH}	CE "H" Input Current	$V_{IN} = 30\text{ V}$, $V_{CE} = 30\text{ V}$	-1.0		1.0	μA
T_{TSD}	Thermal Shutdown Detect Temperature	Hysteresis 30°C		160		°C
Istandby	Standby Current	$V_{IN} = 30\text{ V}$		0	5	μA

OPERATING DESCRIPTIONS

OPERATION OF THE BUCK CONVERTER AND THE OUTPUT CURRENT

The DC/DC converter charges energy in the inductor when the switch turns on, and discharges the energy from the inductor when the switch turns off and controls with less energy loss, so that a lower output voltage than the input voltage is obtained. Refer to the following figures.

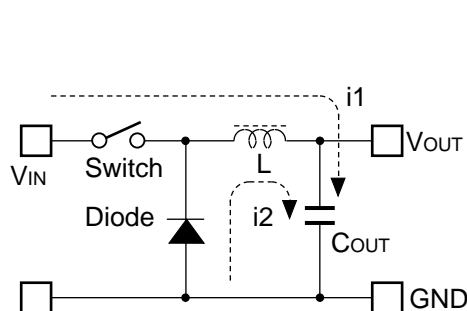

Basic Circuit

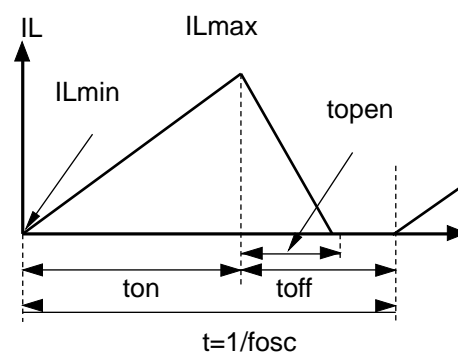

Current flowing through the Inductor

Step 1: The switch turns on and current $I_L (= i_1)$ flows, and energy is charged into C_{OUT} . At this moment, I_L increases from $I_{Lmin} (= 0)$ to reach I_{Lmax} in proportion to the on-time period (t_{on}) of the switch.

Step 2: When the switch turns off, the diode turns on in order to maintain I_L at I_{Lmax} , and current $I_L (= i_2)$ flows.

Step 3: $I_L (= i_2)$ decreases gradually and reaches $I_L = I_{Lmin} = 0$ after a time period of t_{open} , and the diode turns off. This case is called as discontinuous mode. If the output current becomes large, next switching cycle starts before I_L becomes 0 and the diode turns off. In this case, I_L value increases from $I_{Lmin} (> 0)$, and this case is called continuous mode.

In the case of PWM control system, the output voltage is maintained by controlling the on-time period (t_{on}), with the oscillator frequency (f_{osc}) being maintained constant.

R1245x

No. EA-269-201022

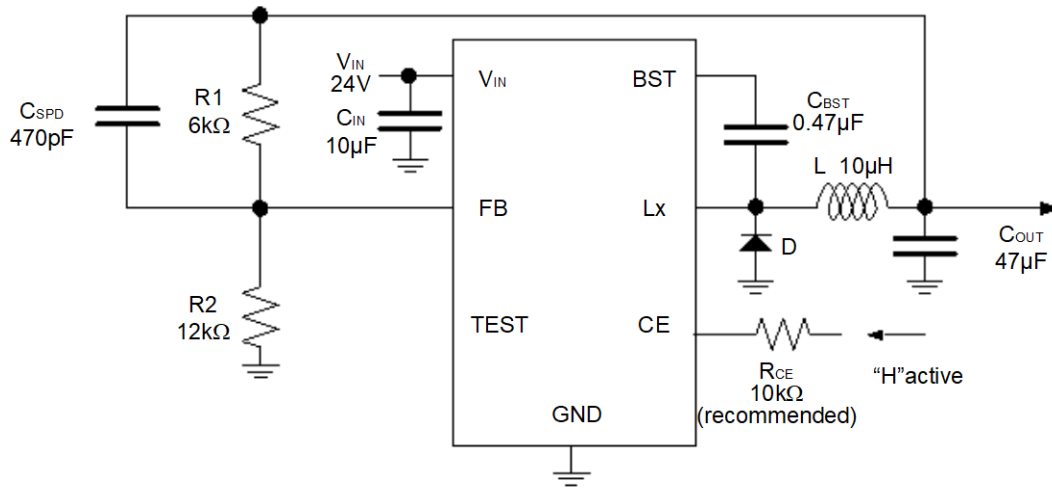
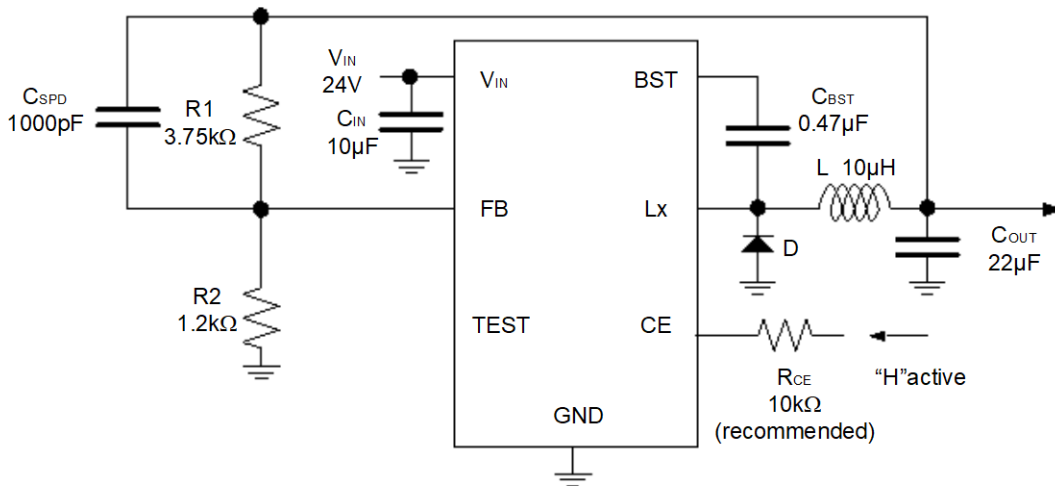
TYPICAL APPLICATION CIRCUIT**R1245x00xA/B Typical Application Circuit, 330 kHz, $V_{OUT} = 1.2$ V, $V_{IN} = 24$ V****R1245x00xC/D Typical Application Circuit, 500 kHz, $V_{OUT} = 3.3$ V, $V_{IN} = 24$ V**

* TEST pin must be open.

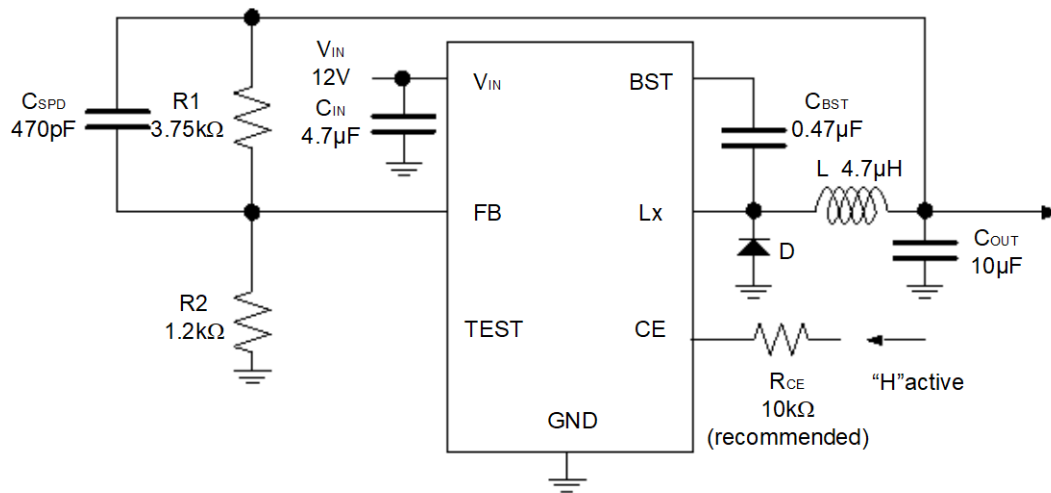

R1245x00xE/F Typical Application Circuit, 1000 kHz, $V_{OUT} = 3.3\text{ V}$, $V_{IN} = 12\text{ V}$

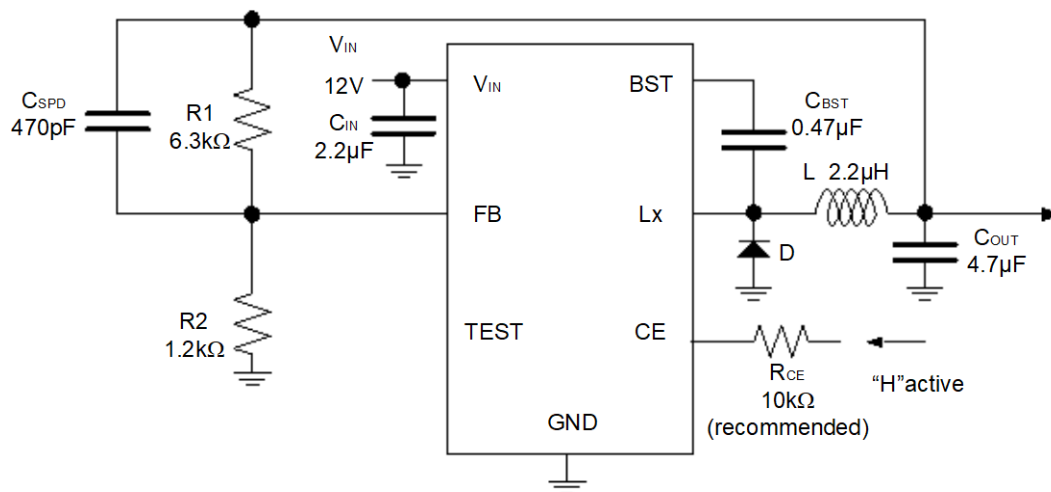

R1245x00xG/H Typical Application Circuit, 2400 kHz, $V_{OUT} = 5.0\text{ V}$, $V_{IN} = 12\text{ V}$

* TEST pin must be open.

OUTPUT CURRENT AND SELECTION OF EXTERNAL COMPONENTS

The relation between the output current and external components is as follows:

When the switch of Lx turns on:

(Wherein, the peak to peak value of the ripple current is described as I_{RP} , the ON resistance of the switch is described as R_{ONH} , and the diode forward voltage as V_F , and the DC resistance of the inductor is described as R_L , and on time of the switch is described as t_{on})

$$V_{IN} = V_{OUT} + (R_{ONH} + R_L) \times I_{OUT} + L \times I_{RP} / t_{on} \dots\dots\dots \text{Equation 1}$$

When the switch turns off (the diode turns on) as toff:

$$L \times I_{RP} / t_{off} = V_F + V_{OUT} + R_L \times I_{OUT} \dots\dots\dots \text{Equation 2}$$

Put Equation 2 to Equation 1 and solve for ON duty of the switch, $t_{on} / (t_{off} + t_{on}) = D_{ON}$,

$$D_{ON} = (V_{OUT} + V_F + R_L \times I_{OUT}) / (V_{IN} + V_F - R_{ONH} \times I_{OUT}) \dots\dots\dots \text{Equation 3}$$

Ripple Current is as follows:

$$I_{RP} = (V_{IN} - V_{OUT} - R_{ONH} \times I_{OUT} - R_L \times I_{OUT}) \times D_{ON} / f_{osc} / L \dots\dots\dots \text{Equation 4}$$

wherein, peak current that flows through L, and the peak current I_{Lmax} is as follows:

$$I_{Lmax} = I_{OUT} + I_{RP} / 2 \dots\dots\dots \text{Equation 5}$$

As for the valley current I_{Lmin} ,

$$I_{Lmin} = I_{OUT} - I_{RP} / 2 \dots\dots\dots \text{Equation 6}$$

If $I_{Lmin} < 0$, the step-down DC/DC converter operation becomes current discontinuous mode.

Therefore the current condition of the current discontinuous mode, the next formula is true.

$$I_{OUT} < I_{RP} / 2 \dots\dots\dots \text{Equation 7}$$

Consider I_{Lmax} and I_{Lmin} , conditions of input and output and select external components.

*The above explanation is based on the calculation in an ideal case in continuous mode.

Ripple Current and Lx Current Limit

The ripple current of the inductor may change according to the various reasons. In the R1245x, as an Lx current limit, Lx peak current limit is used. Therefore the upper limit of the inductor current is fixed.

The peak current limit is not the average current of the inductor (output current). If the ripple current is large, peak current becomes also large. The characteristic is used for the fold-back current limit of version B/D/F/H. In other words, the peak current limit is maintained and the switching frequency is reduced, as a result, the average current of the inductor is reduced. To release this condition, at 170 kHz for version B/D, at 250 kHz for version F, at 400 kHz for version H must not be beyond the peak current limit. In the figure1, the sequence of the Lx current limit function is described.

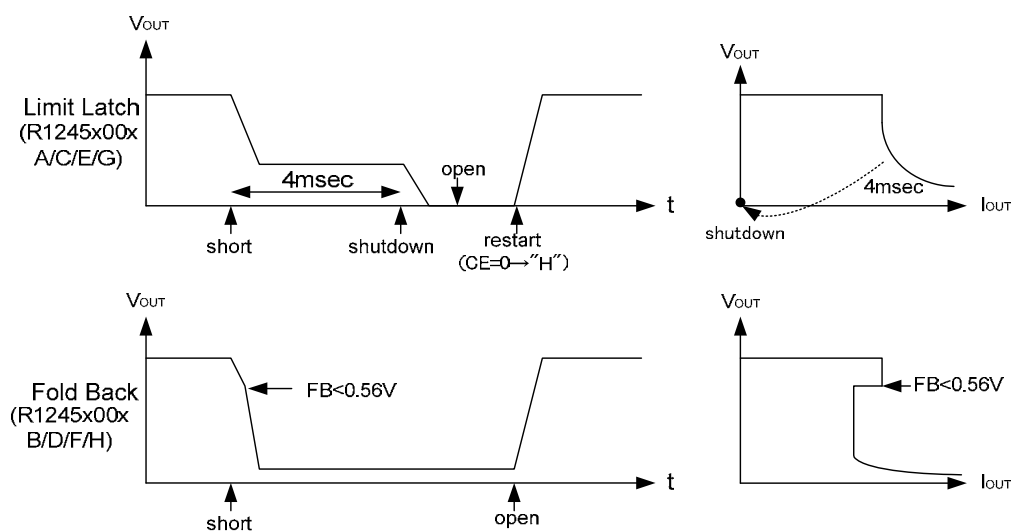

Figure 1. Lx Limit function sequence

R1245x

No. EA-269-201022

Latch Protection Function for Version A/C/E/G

The latch function works after detecting current limit and if the output voltage becomes low for a certain time, the output is latched off. Refer to the TECHNICAL NOTES.

Fold-back Protection Function for Version B/D/F/H

If FB voltage becomes lower than approximately 0.56 V, the fold-back protection function limits the oscillator frequency to typically 170 kHz for version B/D, typically 250 kHz for version F, typically 400 kHz for version H. By reducing frequency, the ripple current increases. The R1245x has the peak current limit function, therefore as in the equation 8, the Lx average current decreases by the increase of the ripple current.

$$I_{OUT} = I_{Lmax} + I_{RP} / 2 \dots \dots \dots \text{Equation 8}$$

If FB voltage becomes less than 0.56 V, the oscillator frequency is reduced. At heavy load, if the R1245x becomes into the fold-back protection mode, the situation may not be released by increase the ripple current. In terms of other notes on this protection function, refer to the TECHNICAL NOTES.

MAXIMUM OUTPUT CURRENT

The output current of the R1245x is limited by the power dissipation P_D of the package and the maximum specification 1.2 A. The loss of the IC includes the switching loss, and it is difficult to estimate. To estimate the maximum output, using the efficiency data is one method.

By using the efficiency data, the loss including the external components can be calculated with the equation, $(100 / \text{efficiency (\%)} - 1) \times (V_{OUT} (V) \times I_{OUT} (A))$. From this equation, by reducing the loss of external components, the loss of the IC can be estimated. The main loss of the external components is composed by the rectifier diode and DCR of the inductor. Supposed that the forward voltage of the diode is described as V_F , the loss of the diode can be described as follows:

$$(V_{IN} (V) - R_{ON} (\Omega) \times I_{OUT} (A) - V_{OUT} (V) - V_F (V)) / V_{IN} (V) \times V_F (V) \times I_{OUT} (A)$$

The loss by the DCR of the inductor can be calculated by the formula $DCR (\Omega) \times I_{OUT}^2 (A)$.

Thus,

$$\text{The loss of the IC} = (100 / \text{efficiency (\%)} - 1) \times (V_{OUT} (V) \times I_{OUT} (A) - (V_{IN} (V) - R_{ON} (\Omega) \times I_{OUT} (A) - V_{OUT} (V) - V_F (V)) / V_{IN} (V) \times V_F (V) \times I_{OUT} (A) - DCR (\Omega) \times I_{OUT}^2 (A))$$

The efficiency of the R1245x at $T_a = 25^\circ\text{C}$, $V_{IN} = 12 \text{ V}$, $V_{OUT} = 3.3 \text{ V}$, $I_{OUT} = 600 \text{ mA}$ is approximately 89.5% for version A/B (Oscillator frequency: 330 kHz). Supposed that the On resistance of the internal driver is 0.35Ω , the DCR of the inductor is $65 \text{ m}\Omega$, the V_F of the rectifier diode is 0.3 V and applied to the formula above,

$$\text{The loss of the IC} = (100\% / 89.5\% - 1) \times (3.3 \text{ V} \times 0.6 \text{ A}) - (12 \text{ V} - 0.35 \Omega \times 0.6 \text{ A} - 3.3 \text{ V} - 0.3 \text{ V}) / 12 \text{ V} \times 0.3 \text{ V} \times 0.6 \text{ A} - 0.065 \Omega \times 0.6^2 \text{ A} = 86 \text{ mW}$$

The power dissipation P_D of the package is specified at $T_a = 25^\circ\text{C}$ based on the $T_{jmax} = 125^\circ\text{C}$. Thus the thermal resistance of the package $\theta_{ja} = (T_{jmax} (^\circ\text{C}) - T_a (^\circ\text{C})) / P_D (W)$, therefore the thermal resistance of the each available package is as follows:

$$\text{HSOP-8E: } (125^\circ\text{C} - 25^\circ\text{C}) / 2.9 \text{ W} = 34.5^\circ\text{C/W}$$

$$\text{DFN(PL)2020-8: } (125^\circ\text{C} - 25^\circ\text{C}) / 0.88 \text{ W} = 114^\circ\text{C/W}$$

$$\text{SOT-23-6W: } (125^\circ\text{C} - 25^\circ\text{C}) / 0.43 \text{ W} = 233^\circ\text{C/W}$$

Due to the loss of the IC is 86mW for this example, therefore T_j increase of the each package is as follows:

$$\text{HSOP-8E: } 34.5^\circ\text{C/W} \times 86 \text{ mW} = 2.96^\circ\text{C}$$

$$\text{DFN(PL)2020-8: } 114^\circ\text{C/W} \times 86 \text{ mW} = 9.80^\circ\text{C}$$

$$\text{SOT-23-6W: } 233^\circ\text{C/W} \times 86 \text{ mW} = 20.0^\circ\text{C}$$

For all the packages, even if the ambient temperature is at 105°C , T_j can be suppressed less than 125°C . By the increase of the temperature, on resistance and switching loss increases, therefore, temperature margin is not enough, measure the efficiency at the actual maximum temperature and recalculation is necessary.

At the same condition, if the preset frequency is 2400 kHz, the efficiency will be down to approximately 81%. The result of the loss calculation is 310 mW, therefore the T_j increase of each package is,

$$\text{HSOP-8E: } 34.5^\circ\text{C/W} \times 310 \text{ mW} = 11^\circ\text{C}$$

$$\text{DFN(PL)2020-8: } 114^\circ\text{C/W} \times 310 \text{ mW} = 35^\circ\text{C}$$

$$\text{SOT-23-6W: } 233^\circ\text{C/W} \times 310 \text{ mW} = 72^\circ\text{C}$$

R1245x

No. EA-269-201022

HSOP-8E can be used at the ambient temperature 105°C, DFN(PL)2020-8 can be used at the ambient temperature up to 90°C, SOT-23-6W can be used at the ambient temperature up to 53°C. Note that the result is different by the frequency.

The next graphs are the output current and estimated ambient temperature limit.

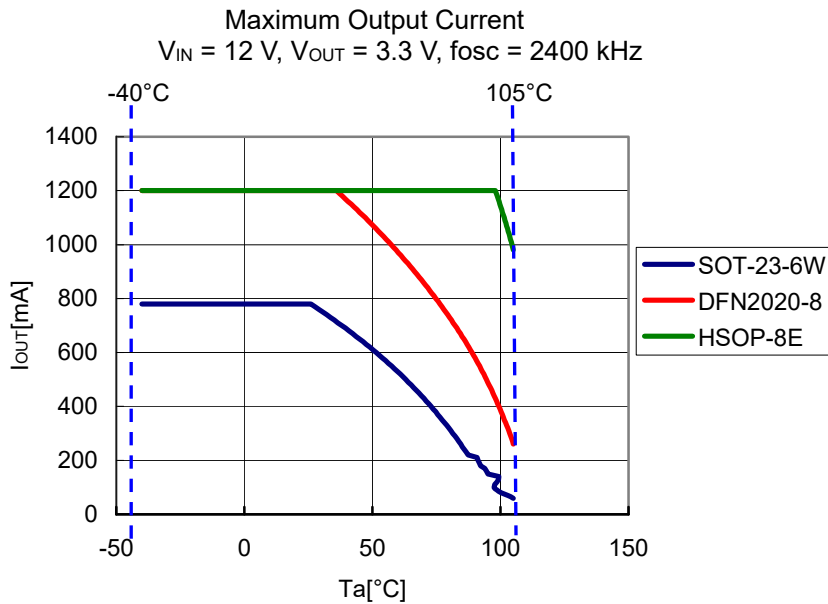
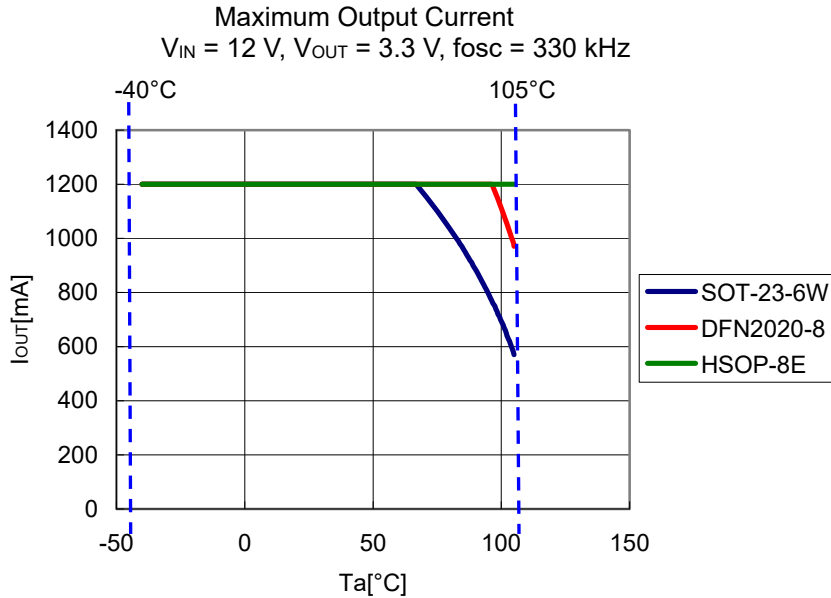

TECHNICAL NOTES

- External components must be connected as close as possible to the ICs and make wiring as short as possible. Especially, the capacitor connected in between VIN pin and GND pin must be wiring the shortest. If their impedance is high, internal voltage of the IC may shift by the switching current, and the operating may be unstable. Make the power supply and GND lines sufficient. In the wiring of the power supply, GND, LX, VOOUT and the inductor, large current by switching may flow. To avoid the bad influence, the wiring between the resistance, “R_{UP}” for setting the output voltage and loading, and the wiring between the inductor and loading must be separated.
- The ceramic capacitors have low ESR (Equivalent Series Resistance) and recommended for the ICs. The recommendation of CIN capacitor between VIN and GND is 10 μF or more for A/B/C/D version, 4.7 μF or more for E/F version, and 2.2 μF or more for G/H version. Verify the bias dependence and the temperature characteristics of the ceramic capacitors. Recommendation conditions are written based on the case which the recommendation parts are used with the R1245x.
- The R1245x is designed with the recommendation inductance value and ceramic capacitor value and phase compensation has been made. If the inductance value is large, due to the lack of current sensing amount of the current mode, unstable operation may result. On the contrary, if the inductance value is small, the current sensing amount may increase too much, low frequency oscillation may occur when the on duty ratio is beyond 50%. Not only that, if the inductance value is small, according to the increase of the load current, the peak current of the switching may increase, as a result, the current may reach the current limit value and the current limit may work.
- As for the diode, use the Schottky diode with small capacitance between terminals. The reference characteristic of the capacitance between terminals is around 100 pF or less at 10 V. If the capacitance between terminals is large, excess switching current may flow and the operation of the IC may be unstable. If the capacitance between terminals of the Schottky diode is beyond 100 pF at 10 V or unknown, verify the load regulation, line regulation, and the load transient response.
- Output voltage can be set by adjustment of the values of R1 and R2. The equation of setting the output voltage is $V_{OUT} = V_{FB} \times (R1 + R2) / R2$. If the values of R1 and R2 are large, the impedance of FB pin increases, and pickup the noise may result. The recommendation value range of R2 is approximately between 1.0 kΩ to 16 kΩ. If the operation may be unstable, reduce the impedance of FB pin.
- For the CE pin, as an ESD protection element, a diode to VIN pin is formed internal of the IC. If CE pin voltage may become higher than VIN pin voltage, to prevent flowing large current from CE pin to VIN pin, connect 10 kΩ or more resistor between CE and VIN pin.
- Connect the backside heat radiation tub of the DFN(PL)2020-9/HSOP-8E to the GND. As for multi-layered boards, to make better power dissipation, putting some thermal via on the thermal pad in the land pattern and radiation of the heat to another layer is effective.
- After the soft-start operation, the latch function is enabled for version A/C/E/G. The latch protection starts the internal counter when the internal current limit protection circuit detects the current limit. When the internal counter counts up to the latch timer limit, typically 4 ms, the output is latched off. To reset the latch function, make the CE pin “L”, or make VIN pin voltage lower than UVLO detector threshold. Then in the case that the output voltage or FB voltage becomes setting voltage within the latch timer preset time, counter is initialized. If the slew rate of the power supply is too slow and after the soft-start time, the output voltage does not reach the set output voltage even if the latch timer preset time is over, the latch function may work unexpectedly.

R1245x

No. EA-269-201022

- After the soft-start operation, fold-back protection function is enabled for version B/D/F/H. The fold-back function will limit the oscillator frequency if the FB pin voltage becomes lower than typically 0.56 V. For B/D version, the oscillator frequency will be reduced typically into 170 kHz, for F version, into 250 kHz, for H version, into 400 kHz.
- If the slew rate of the power supply is too slow, and even after the soft-start time, the output voltage is still less than 70% of the set output voltage, or FB pin voltage is less than typically 0.56 V, then this function may work unexpectedly.
- The performance of power circuit using this IC largely depends on external components. Selection of external components is very important, especially, do not exceed each rating value (voltage/current/power).

Table 1. Recommended Values for Each Output Voltage

R1245x00xA/B: 330 kHz

V _{OUT} (V)	0.8 to 1.2	1.2 to 2.5	2.5 to 5.0	5.0 ≤
R1 (R _{UP}) (kΩ)	= (V _{OUT} / 0.8 - 1) × R2			
R2 (R _{BOT}) (kΩ)	16	12	1.20	1.20
C _{SPD} (pF)	open	470	2200	1000
C _{OUT} (μF)	47	47	22	22
L (μH)	4.7	10	15	33

R1245x00xC/D: 500 kHz

V _{OUT} (V)	0.8 to 1.2	1.2 to 1.5	1.5 to 2.0	2.0 to 5.0	5.0 to 12.0	12.0 ≤
R1 (R _{UP}) (kΩ)	= (V _{OUT} / 0.8 - 1) × R2					
R2 (R _{BOT}) (kΩ)	16	16	16	1.2	1.2	1.2
C _{SPD} (pF)	open	100	100	1000	1000	470
C _{OUT} (μF)	100	100	22	22	22	22
L (μH)	4.7	4.7	10	10	15	15

R1245x00xE/F: 1000 kHz

V _{OUT} (V)	0.8 to 1.0	1.0 to 1.2	1.2 to 1.5	1.5 to 2.5	2.5 to 5.0	5.0 ≤
R1 (R _{UP}) (kΩ)	= (V _{OUT} / 0.8 - 1) × R2					
R2 (R _{BOT}) (kΩ)	16	16	16	16	1.2	1.2
C _{SPD} (pF)	open	100	100	100	470	470
C _{OUT} (μF)	100	100	47	22	10	10
L (μH)	2.2	2.2	2.2	2.2	4.7	10

R1245x00xG/H: 2400 kHz

V _{OUT} (V)	1.2 to 1.8	1.8 to 2.5	2.5 to 5.0	5.0 ≤
R1 (R _{UP}) (kΩ)	= (V _{OUT} / 0.8 - 1) × R2			
R2 (R _{BOT}) (kΩ)	16	12	1.2	1.2
C _{SPD} (pF)	100	100	470	470
C _{OUT} (μF)	10	10	4.7	4.7
L (μH)	1.0	1.5	2.2	4.7

***1 Divider Resistors Values and Possible Setting Range of Input/ Output**

V _{OUT} [V]	R1 (R _{UP}) [kΩ]	R2 (R _{BOT}) [kΩ]	Input Voltage Range [V]			
			Ver. A/B	Ver. C/D	Ver. E/F	Ver. G/H
0.8	0	open	4.5 to 20	4.5 to 13.5	4.5 to 7	-
	0	16				
1	4	16	4.5 to 25.5	4.5 to 17	4.5 to 8.5	-
1.2	8	16	4.5 to 30	4.5 to 20	4.5 to 10	-
	6	12				
1.5	10.5	12	4.5 to 30	4.5 to 25	4.5 to 12.5	4.5 to 5.5
	14	16				
1.8	20	16	4.5 to 30	4.5 to 30	4.5 to 15	4.5 to 6.5
	15	12				
2	24	16	4.5 to 30	4.5 to 30	4.5 to 17	4.5 to 7
	1.8	1.2				
2.5	34	16	4.5 to 30	4.5 to 30	4.5 to 21	4.5 to 9
	25.5	12				
	2.55	1.2				
3.3	3.75	1.2	4.5 to 30	4.5 to 30	4.5 to 27.5	4.5 to 12
5	6.3	1.2	5.5 to 30	5.5 to 30	6 to 30	7 to 18.5
6	7.8	1.2	6.5 to 30	6.5 to 30	7 to 30	8 to 20
9	12.3	1.2	10 to 30	10 to 30	11 to 30	12 to 30
12	16.8	1.2	13 to 30	13 to 30	14 to 30	16 to 30
15	21.3	1.2	16.5 to 30	16.5 to 30	17 to 30	20 to 30
24	34.8	1.2	26.5 to 30	26.5 to 30	27.5 to 30	30

Table 2. Recommended External Components Examples (Considering All the Range)

Symbol	Condition	Value	Parts Name	MFR
C _{IN}	50 V/ X5R	10 μ F	UMK325BJ106MM-P	TAIYO YUDEN
	50 V/ X5R	10 μ F	CGA6P3X7S1H106K	TDK
	50 V/ X7R	4.7 μ F	GRM31CR71H475KA12L	Murata
	50 V/ X7R	2.2 μ F	GRM31CR71H225KA88L	Murata
C _{OUT}	50 V/ X5R	10 μ F	UMK325BJ106MM-P	TAIYO YUDEN
	50 V/ X5R	10 μ F	CGA6P3X7S1H106K	TDK
	50 V/ X7R	10 μ F	KTS500B106M55N0T00	Nippon Chemi-Con
	25 V/ X7R	10 μ F	GRM31CR71E106K	Murata
	10 V/ X7R	22 μ F	GRM31CR71A226M	Murata
	16 V/ B	47 μ F	GRM32EB31C476KE15	Murata
	10 V/ X7R	47 μ F	GRM32ER71A476KE15	Murata
			NOTE: The value of C _{OUT} depends on the setting output voltage.	
C _{BST}	16 V/ X7R	0.47 μ F	EMK212B7474KD-T	TAIYO YUDEN
L	1.8 A	10 μ H	SLF6045T-100M1R6-3PF	TDK
	1.65 A	4.7 μ H	SLF7045T-4R7M2R0-PF	TDK
	1.7 A	4.7 μ H	NR4018T-4R7M2R0-PF	TDK
	2.4 A	4.7 μ H	NR6020T4R7N	TAIYO YUDEN
	1.9 A	10 μ H	NR6028T100M	TAIYO YUDEN
	2.3 A	15 μ H	NR6045T150M	TAIYO YUDEN
	1.9 A	22 μ H	NR6045T220M	TAIYO YUDEN
	1.9 A	33 μ H	NR8040T330M	TAIYO YUDEN
	1.7 A	2.2 μ H	VLCF4020T-2R2N1R7	TDK
	1.65 A	2.2 μ H	NR4012T2R2M	TAIYO YUDEN
	1.8 A	1.5 μ H	NR3015T1R5N	TAIYO YUDEN
	1.8 A	1.0 μ H	NR4010T1R0N	TAIYO YUDEN
D	30 V/ 2.0 A	0.37 V	CMS06	TOSHIBA
	40 V/ 2.0 A	0.55 V	CMS11	TOSHIBA
R _{CE}	An up diode is formed between the CE pin and the VIN pin as an ESD protection element. If the CE pin may become higher than the voltage of the VIN pin, connect the 10 k Ω resistance between the CE pin and VIN pin, to prevent a large current from flowing into the VIN pin from the CE pin.			

APPLICATION INFORMATION

TO IMPROVE THE PERFORMANCE

The R1245 can make its performance better, by adding components as shown below.

Cspd: Speed up capacitor

Cspd has two roles, one is to improve the stability, and the other is to improve the transient speed. The transfer function from V_{OUT} (-which is made of Cspd and feedback resistors, R1(Rup) and R2(Rbot)) to FB will make a forward bump by low frequency zero and high frequency pole, and improve the stability of feedback loop. Cspd can improve the gain and make the transient speed fast at high frequency.

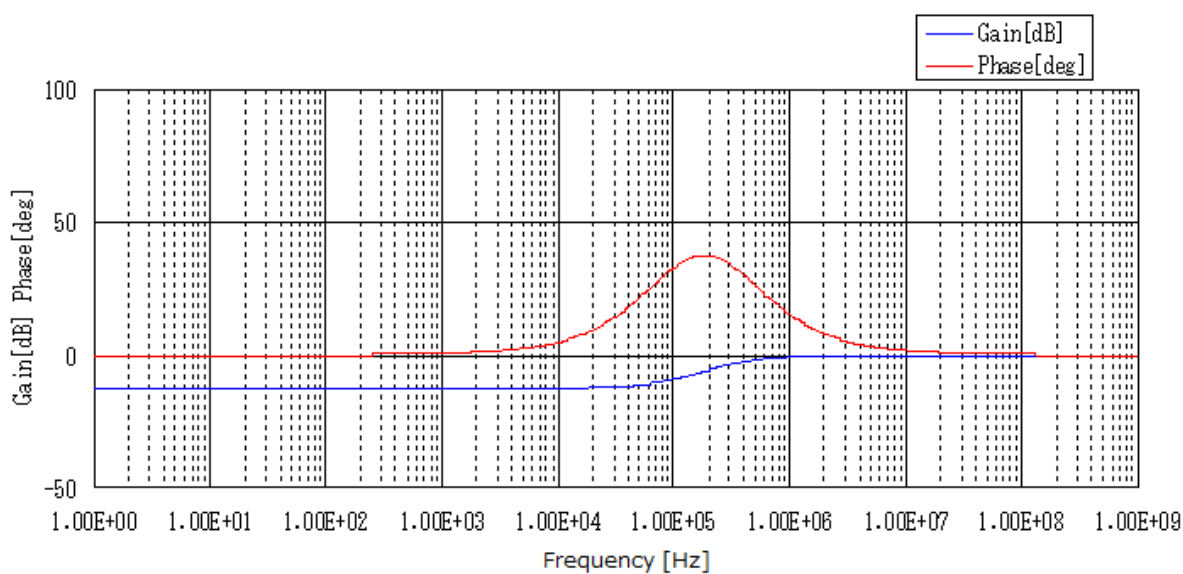

Figure 2. Transfer function BODE plot from V_{OUT} to FB (R1=3.75k Ω , R2=1.2k Ω , Cspd=470pF)

To improve the stability

If the resistance values of the R1 and R2 have to be changed, make the value of $R1 \cdot C_{spd}$ be constant.

(For example, with the R1245x00xA/B and making $V_{OUT}=1.2V$, if $R1=0.6k\Omega$, $R2=1.2k\Omega$ are used, $C_{spd}=4700pF$. By making the values of R1 and R2 increase, the impedance of FB pin also increases, as a result, the influence by noise must be cared. To avoid this, recommendation value range of R2 is from $1.0k\Omega$ to $16k\Omega$. If the operation becomes unstable by increasing the impedance, choose low resistance value.

If C_{OUT} and L are necessary to be changed, or unusual voltage setting is necessary, the C_{spd} value must be adjusted. The instruction of the adjustment is as follows:

1. Without C_{spd} , measure the output under-shoot amount by load transient response.
2. Further, with using a small value C_{spd} , measure the output under-shoot amount by load transient response. The appropriate initial value is about 1/10 of the recommendation C_{spd} value. If C_{spd} is too small, the under-shoot amount is almost same as the one without C_{spd} . If the value of C_{spd} is changed bigger gradually, the under-shoot amount will be less. Supposed that this new good C_{spd} as C_{spd1} , and continue to make it bigger, and finally, the under-shoot amount becomes unchanged, at this point, supposed that the maximum C_{spd} as C_{spd2} .
3. Select an appropriate value according to the formula, $C_{spd}=\sqrt{(C_{spd1} \cdot C_{spd2})}$.

To improve the transient response speed

If the stability is enough, (for example, in the case that C_{OUT} is big enough), make C_{spd} value bigger. The stability will be same, but the gain at high frequency will be large, and improve the transient response speed. However, if C_{spd} value is set C_{spd2} value or more, the result will not be improved, not only that, due to the high gain at high frequency, compared with the result without C_{spd} , the stability will be worse.

① $R1=3.75k\Omega$, $R2=1.2k\Omega$, Cspd: none, $V_{OUT}=3.3V$

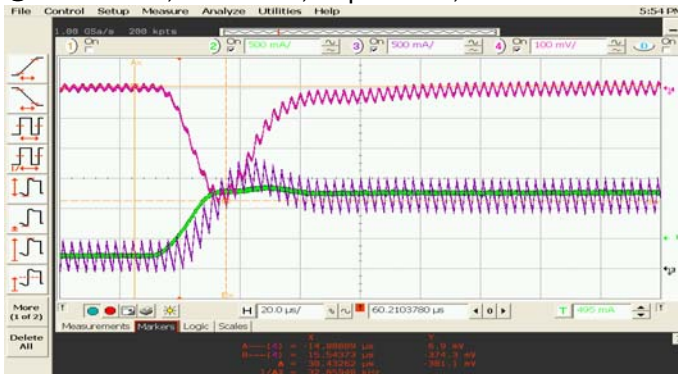

V_{OUT}
 I_{LX}
 I_{OUT}

Due to no Cspd, the stability is not good enough, and under-shoot amount is big during the load transient.

② $R1=3.75k\Omega$, $R2=1.2k\Omega$, Cspd=2200pF, $V_{OUT}=3.3V$

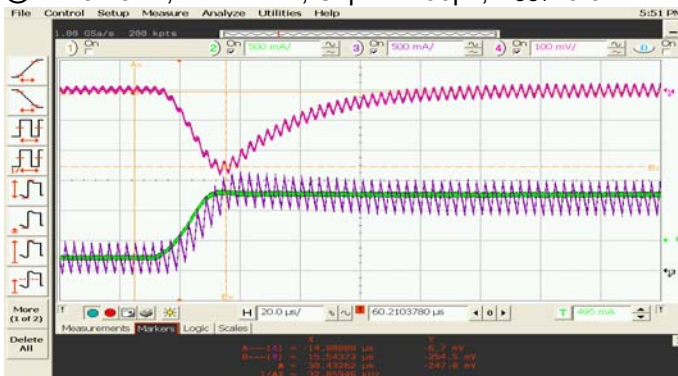

V_{OUT}
 I_{LX}
 I_{OUT}

Cspd value is appropriate, and stability and response speed is adjusted properly.

③ $R1=3.75k\Omega$, $R2=1.2k\Omega$, Cspd=33000pF, $V_{OUT}=3.3V$

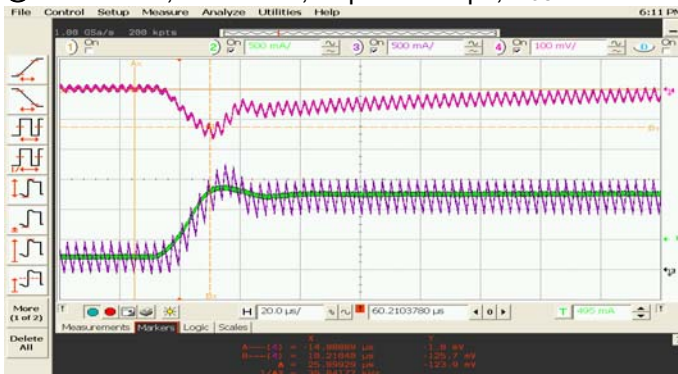

V_{OUT}
 I_{LX}
 I_{OUT}

Cspd value is too big, the response speed is fast, but the stability decreases slightly.

Rspd: Noise reduction filter for speed up capacitor

Cspd can improve the high frequency characteristics due to its differential function. In other words, the high frequency component is passed through without change, therefore the spike noise of V_{OUT} is transferred to FB pin as it is. If the spike noise is too big, by its noise of FB pin, the output voltage may be changed especially at heavy load. To avoid this situation, by setting an Rspd which inserts in series in Cspd and making a pole at high frequency, filtering is possible and effective. The appropriate value range of Rspd is from 10Ω to 30Ω . If the resistance value is too big, the effect of Cspd is cancelled by the lowering pole at high frequency by Rspd. By removing FB pin noise, using low R1 and R2 resistance value.

VOLTAGE BETWEEN Lx PIN AND BST PIN

In the boot-strap style switching regulator, when the Lx pin voltage becomes lower than the regulator which supplies BST voltage, C_{BST} is charged.

By this charge, while the Lx pin voltage is "H", high side switch can be turned on continuously. Therefore, if Lx pin voltage does not become lower than the BST voltage supply regulator, switching may be abnormal. In the R1245, the output voltage of the BST voltage supply regulator is set at 5V. The abnormal switching may be caused by the following conditions:

• $V_{OUT} > 5V$, the difference between V_{IN} and V_{OUT} is small, inductor current is discontinuous by light load

When the inductor current is continuous, or load current is big enough even if the discontinuous mode, the forward current of the diode will make Lx pin voltage down and C_{BST} is charged, but at light load, Lx pin voltage does not become low enough against the BST voltage supply regulator output (5V). The voltage of C_{BST} is not high enough and drive capability will be down. (Figure 3-①) Due to the lack of the drive capability, V_{OUT} cannot be maintained, and under-shoot happens to V_{OUT} , Lx pin voltage may become lower than the BST voltage supply regulator output (5V), but the error amplifier operation may be abnormal. When the charge of C_{BST} is recovered and normal switching starts, V_{OUT} becomes back to set output voltage. However, after recovering the V_{OUT} , to recover the error amplifier's operation, some response time is necessary, during this response time, V_{OUT} may be over-shoot. (Figure 3-②) As a result, Lx pin voltage cannot be low enough against the BST voltage supply regulator output voltage (5V), under-shoot and over-shoot may be repeated. (Figure 4)

Abnormal waveforms are shown in the next figures. Figure 3: V_{IN} voltage start-up is slower than the soft-start time Figure 4: The voltage difference between input and output is small and load current is small
In both cases, the voltage between Lx pin and BST pin is not enough.

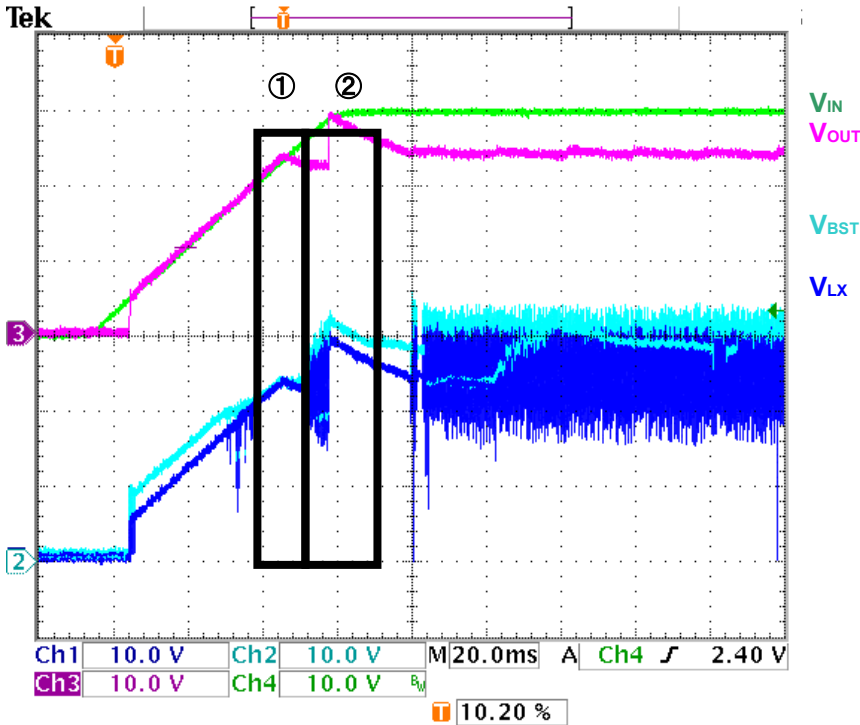

Figure 3. V_{IN} slow start-up (R1245S003A: $V_{IN}=30V$, $V_{OUT}=24V$, $I_{OUT}=0mA$)

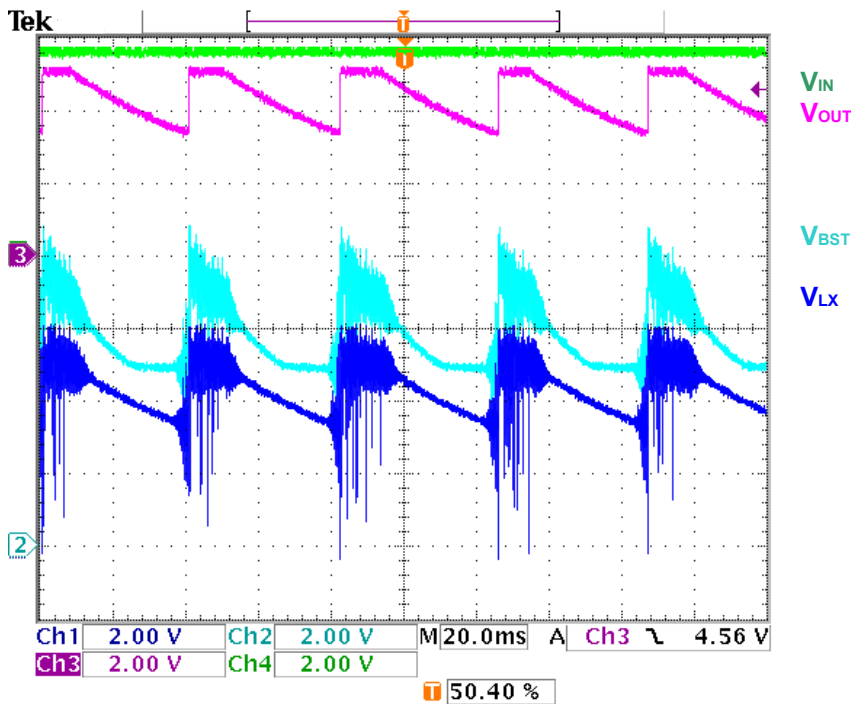

Figure 4. The voltage difference between input and output is small (R1245S003A $V_{IN}=5.5V$, $V_{OUT}=5V$, $I_{OUT}=500\mu A$)

To avoid these situations, please refer to the countermeasures shown below:

- If start-up with $V_{OUT}>5V$ is necessary, avoid the extremely low load, and start up should be done by CE pin control after V_{IN} becomes high enough.
- If $V_{OUT}>5V$ at low load operation is necessary, make the inductance value bigger and assure the "L" time of Lx.
- If start-up with $V_{IN}=CE$ is necessary, avoid very slow V_{IN} setting and low load current condition.

During the output overshoot while the normal transient response, even the no-switching condition happens, the operation keeps normal. Other than that, low load condition with $V_{OUT}<5V$ is also normal condition for the device.

MINIMUM ON TIME

The minimum On time of the R1245 is Typ.110ns. 110ns derives from the current sense circuit delay time and stability.

The R1245 has adopted current mode control without an external sense resistance. Instead of the external sense resistance, the on resistance of the N-channel driver: R_{ON} is used. $V_{IN}-V_{LX}=I_{LX}\times R_{ON}$, therefore I_{LX} (inductor current) can be sensed. I_{LX} can be sensed during the on time of the N-channel driver, ($Lx="H"$), if Lx switching surge is sensed just after turning on, the operation may be abnormal, therefore, just after turning on the N-channel driver, sensing is stopped for a short period and avoid the error by the switching surge.

Therefore, during this sensing delay time, current mode control and current limit cannot operate properly.

Figure 5. X-axis: On time, Y-axis: Current limit

By this current sense delay time, 110ns or less, current limit circuit has also delay time, and detecting current increases drastically. This delay time includes the signal delay time from the current sense circuit to the driver.

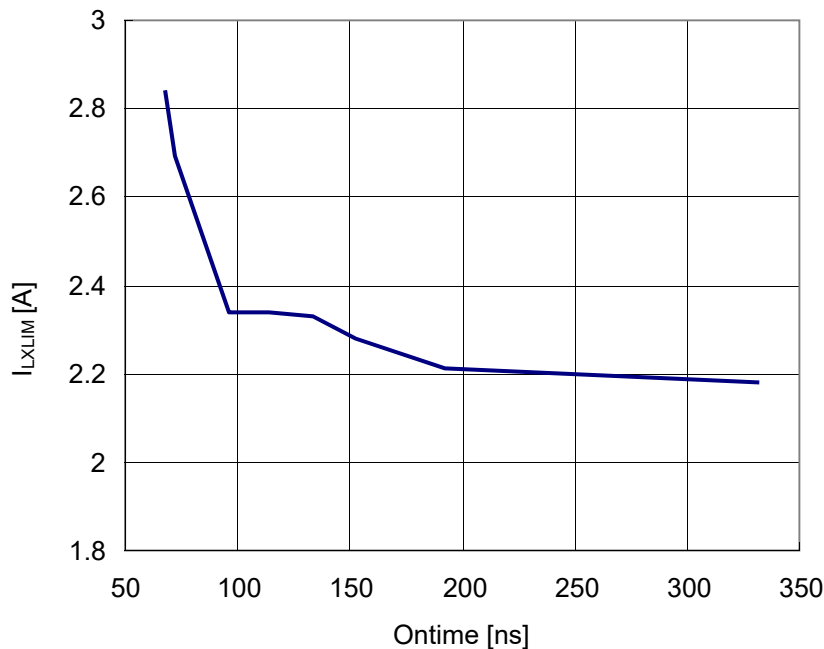

Figure 5. On time and Lx current limit, Lx pin current peak value I_{LX_LIM}

This could be applied to the current mode control. Therefore, 110ns or less, current mode control does not work correctly, and operation becomes like a low stability voltage control mode.

Thus, if the condition of switching on time of the R1245 becomes less than 110ns, stability and current limit detecting accuracy are deteriorated. The higher the switching frequency and the input voltage, the higher current limit detecting threshold is and output and GND short must be cared. Under such conditions, the stability must be assured by the external components, and over current protection other than the IC is necessary. (ex. Using a fuse with the IC.)

INPUT VOLTAGE TRANSIENT

In the R1245, if the voltage between input and output is small and max. duty condition, or if the input voltage changes from lower than the set output voltage to high voltage rapidly, depending on the setting frequency of the R1245, output voltage may be over-shoot to input voltage.

Figure 6: Output voltage is set at 5V, and the input voltage is also set at 5V. The figure shows the input voltage transient response of the input voltage from 5V to 15V rapidly. External voltages: General recommendation values on datasheet, load 20Ω resistance, or 250mA load current.

In the high switching frequency type, the response speed is excellent, therefore, input transient characteristic is good, and over-shoot is suppressed. If input voltage rapid change must be considered, choose the high frequency type.

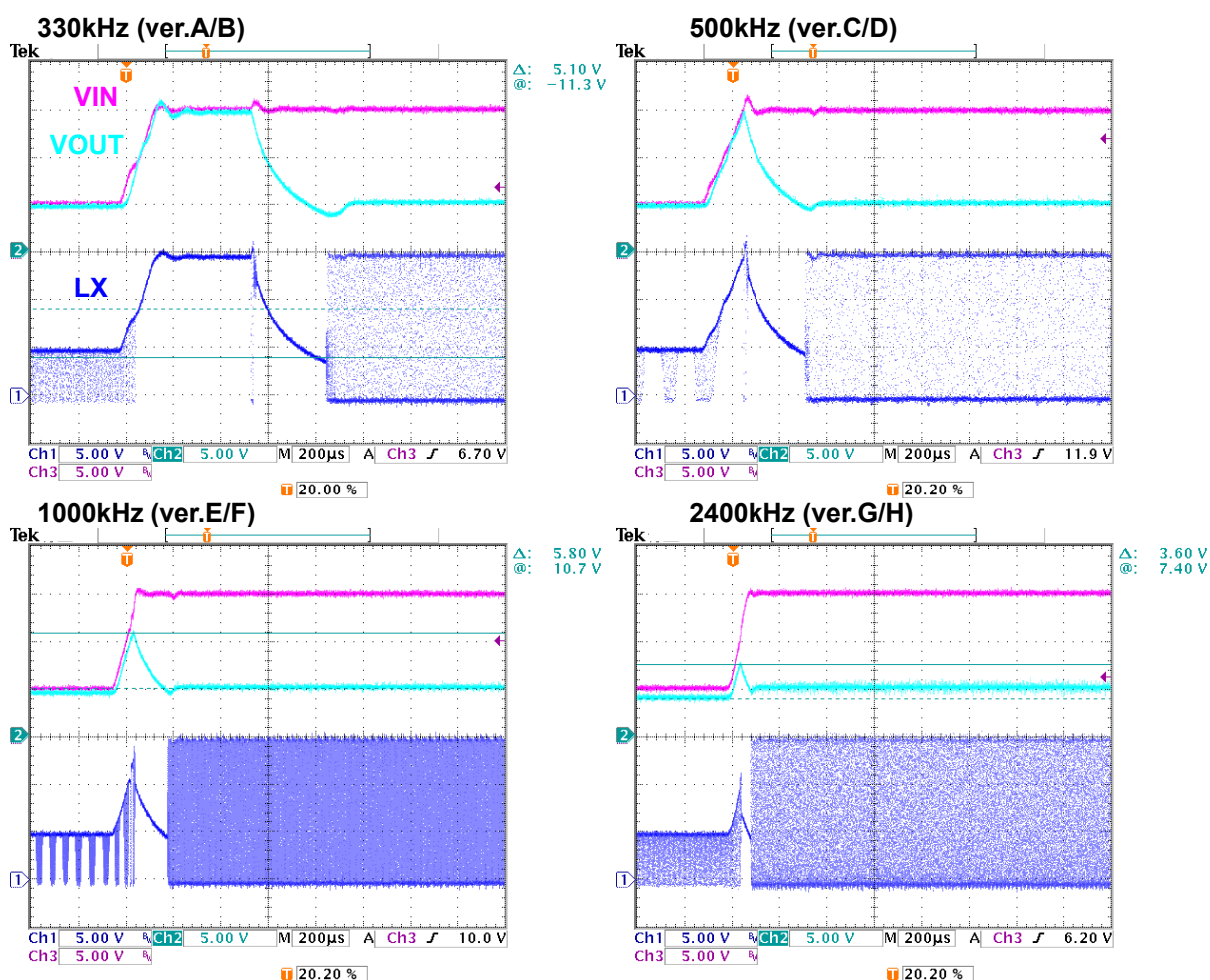

Figure 6. Input transient response from low difference voltage between input and output to high voltage

If the difference between input and output is large, then over-shoot will not happen. In the Figure 7, Other than the start VIN, the conditions are same as Figure 6. VIN is changed from 8V to 18V, 330kHz type, input transient response. Frequency is the lowest, but there is no over-shoot.

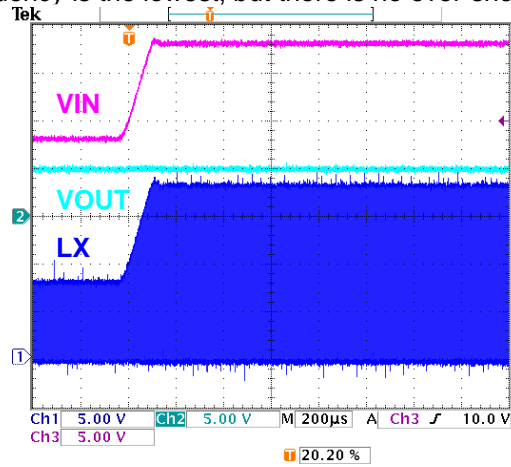

Figure 7. Input transient response from the big difference between input and output

To improve the situation shown in Figure 6, as shown in Figure 8, by using a zener diode, ZD and resistance, when the VIN decreases, CE pin is set at "L" and make the IC standby, over-shoot will be suppressed. Because, when the VIN goes up again and IC becomes active, soft-start function will work. If the input voltage, VIN goes down, Before the set output voltage V_{SET} against VIN ratio, (V_{SET}/VIN) becomes more than the max. duty, CE voltage must be "L". Consider this ratio and choose ZD voltage, or under the ZD, the voltage made by divider resistors must be forced to CE.

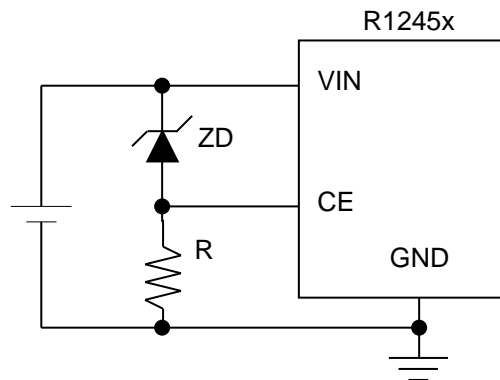

Figure 8. Low input voltage countermeasure circuit with using ZD

THE NOTE OF LAYOUT PATTERN

1. The wire of Power line (V_{IN} , GND) should be broad to minimize the parasitic inductance. The Bypass capacitor (C_{IN}) must be connected as close as possible in between V_{IN} – GND.
2. The wire between Lx pin and the inductor as short as possible to minimize the parasitic inductance.

This evaluation board is designed for the product evaluation board. Therefore large inductors or diodes can be set and the large space of Lx area has been secured. The evaluation board, R1245K003x (2400 kHz) with the reduced mounting area including external components, is available due to the small package of R1245K003G/H and the low recommended constant numbers including inductors.

3. The ripple current flows through the output capacitor. If the GND side of the output capacitor is connected very close to GND pin of the IC, the noise might have a bad impact on the IC. Therefore, the GND side of the output capacitor is better to connect to the outside of the GND of the C_{IN} , or connect to the GND plain layer.
4. R_{up} , R_{bot} , C_{spd} , and R_{spd} should be mounted on the position as close as possible to the FB pin, and away from the inductor and BST pin.
5. The feed-back must be made as close as possible from the Output capacitor (C_{OUT}).

R1245x

No. EA-269-201022

PCB LAYOUT

R1245N001x

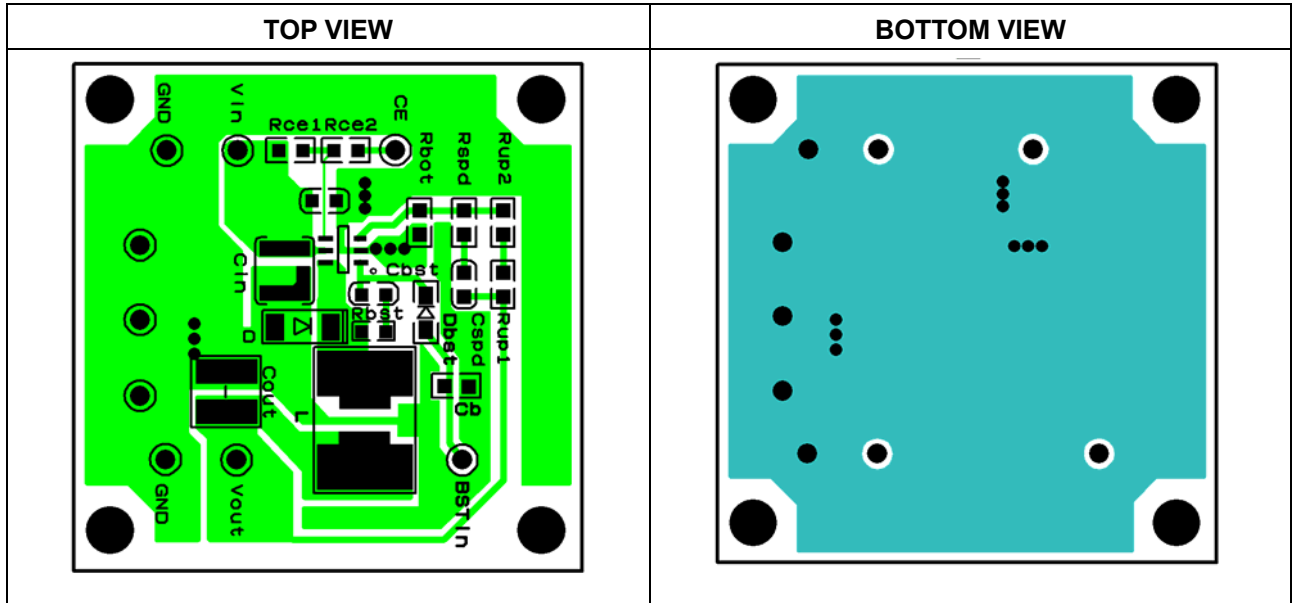

R1245S003x

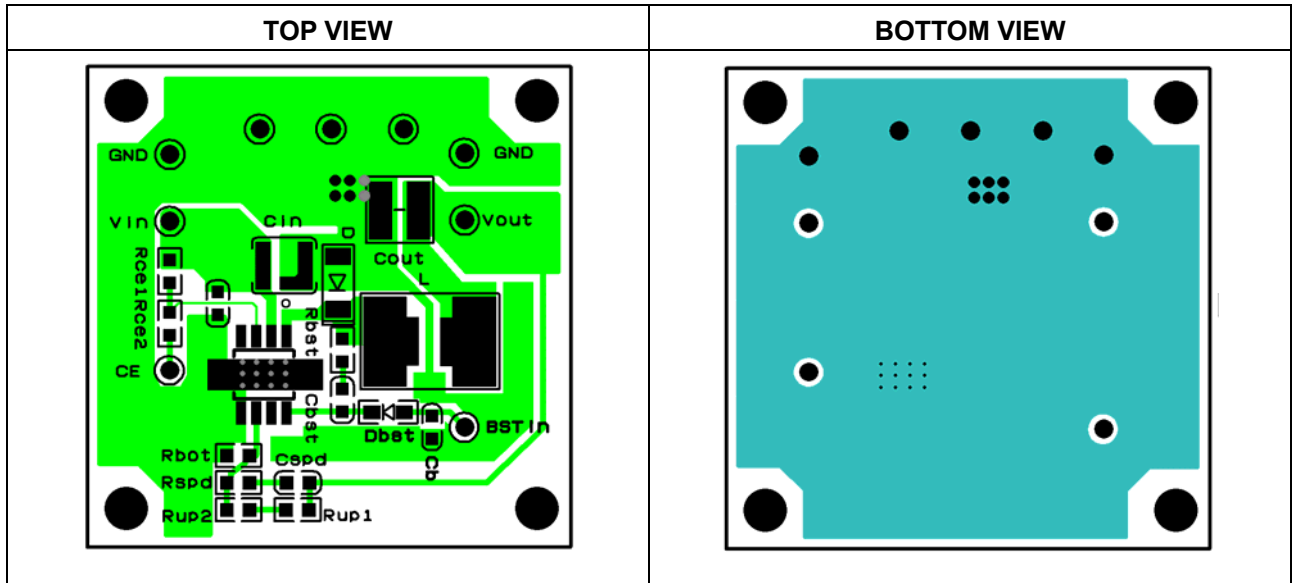

R1245K003x

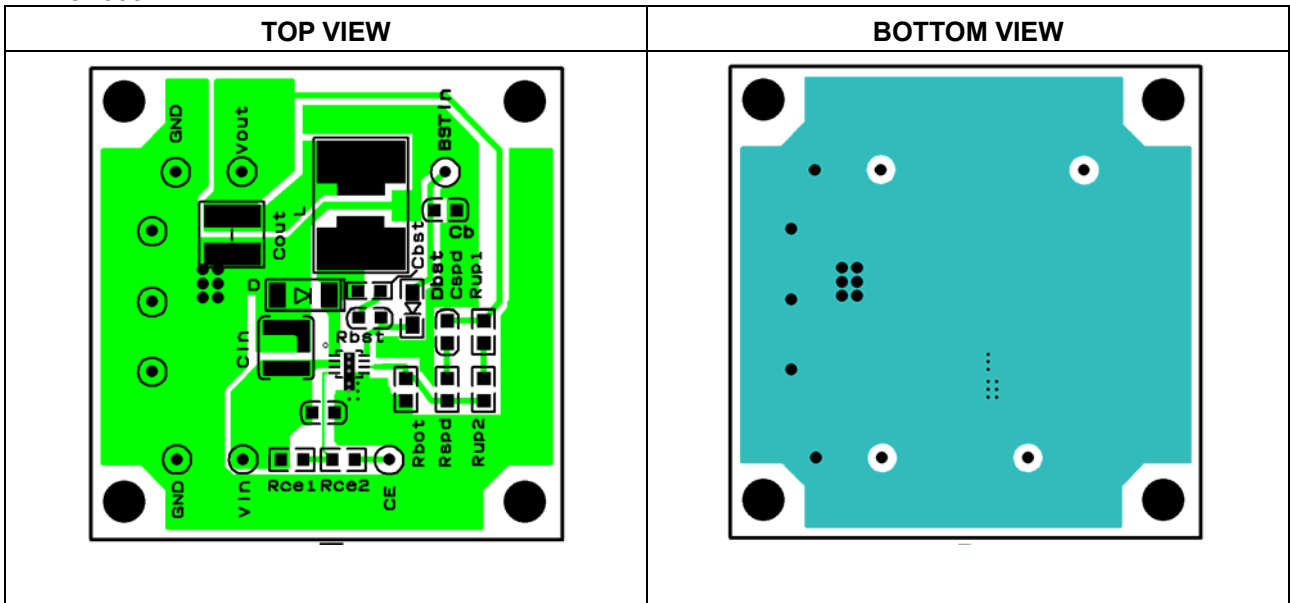

R1245K003x (2400 kHz)

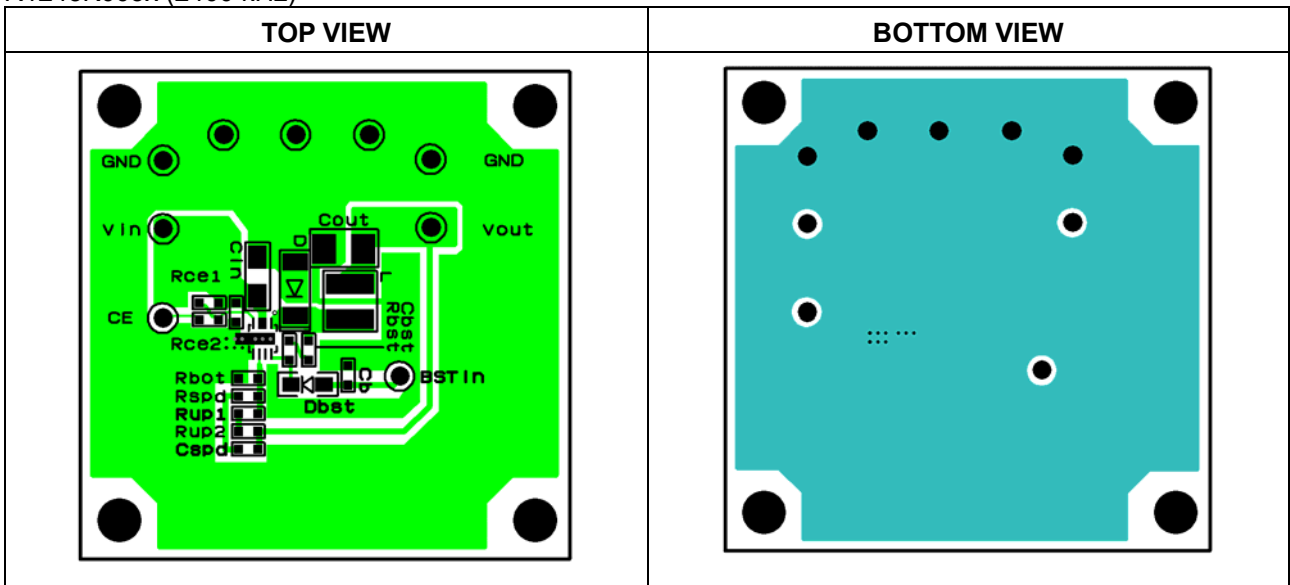

TYPICAL CHARACTERISTICS

Note: Typical Characteristics are intended to be used as reference data; they are not guaranteed.

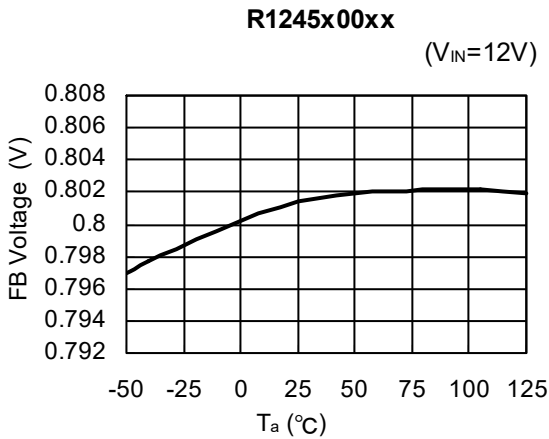
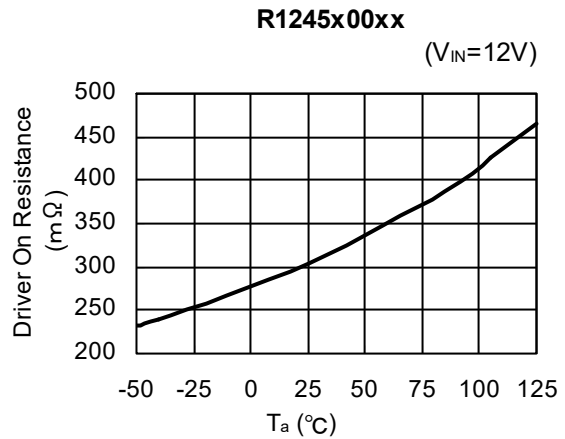
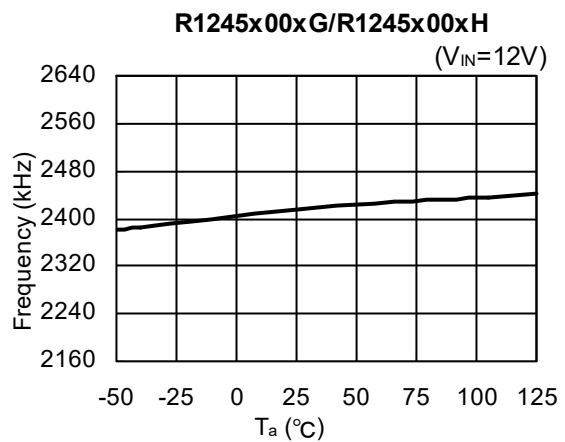
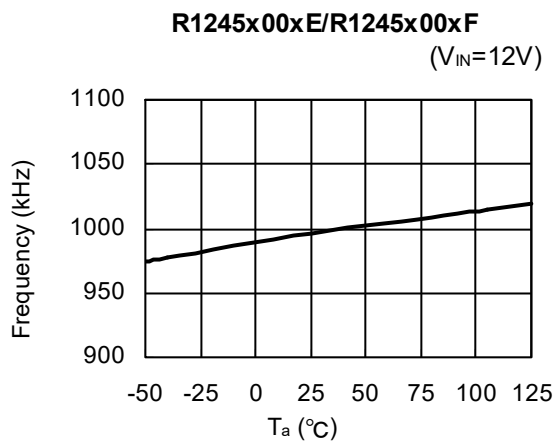
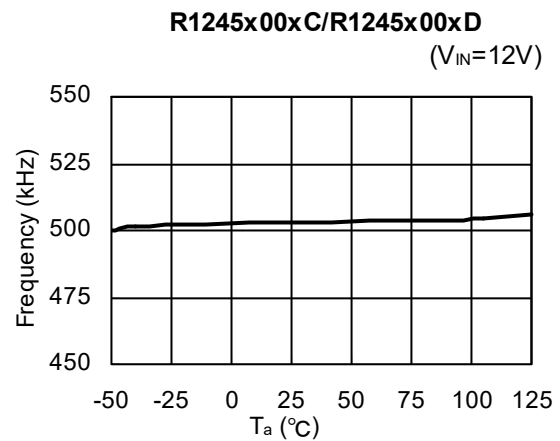
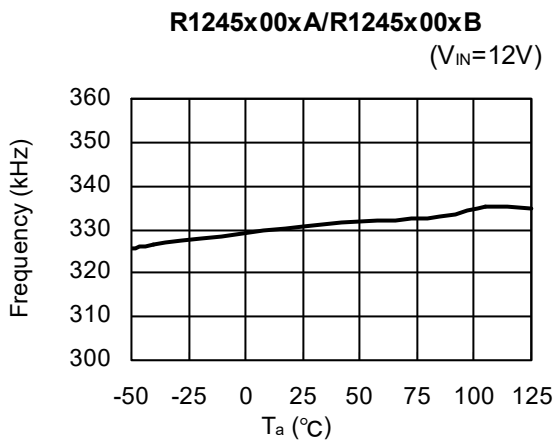
1) FB voltage vs. Temperature**2) Driver On resistance vs. Temperature****3) Oscillator frequency vs. Temperature**

4) Maximum duty cycle vs. Temperature

R1245x00xA/R1245x00xB
(V_{IN}=12V)

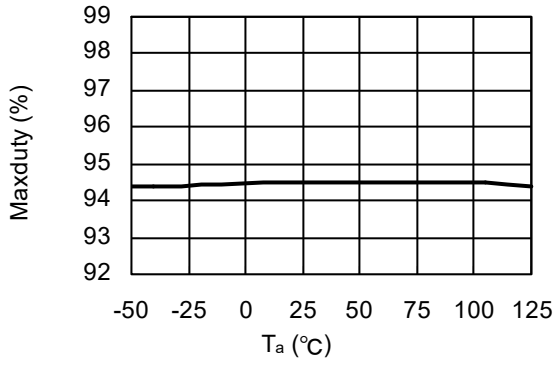

R1245x00xC/R1245x00xD
(V_{IN}=12V)

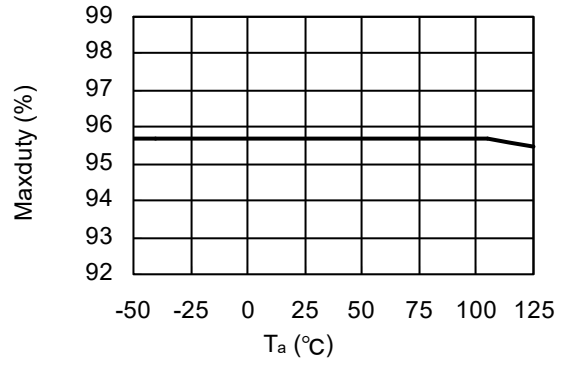

R1245x00xE/R1245x00xF
(V_{IN}=12V)

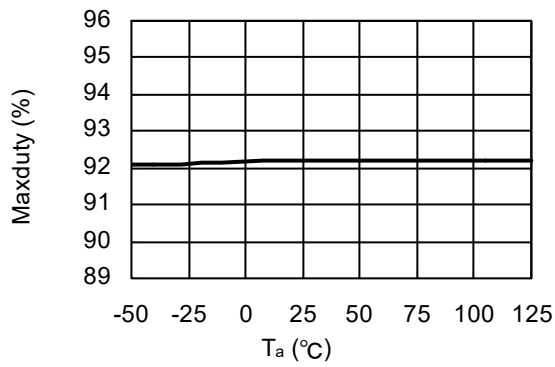

R1245x00xG/R1245x00xH
(V_{IN}=12V)

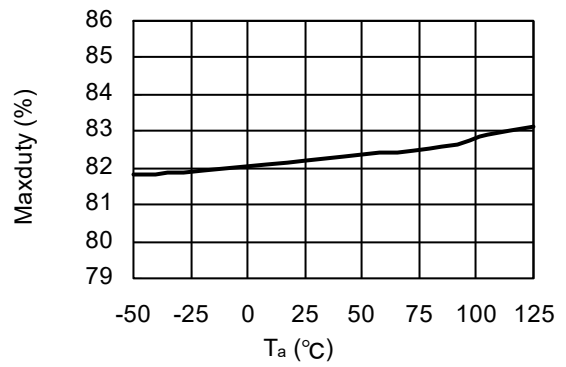

R1245x

No. EA-269-201022

5) Fold back frequency vs. Temperature

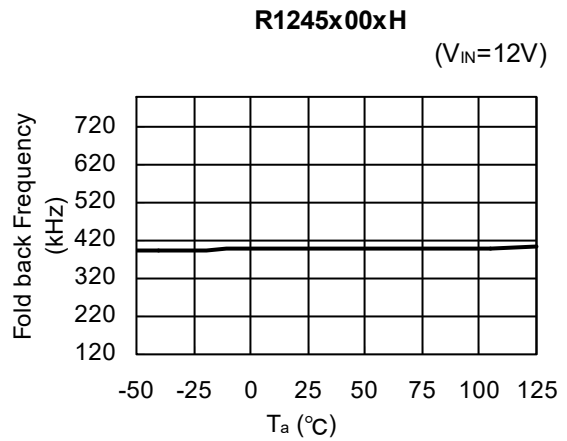
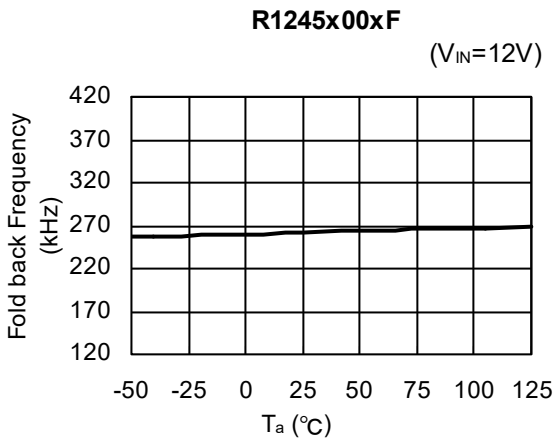
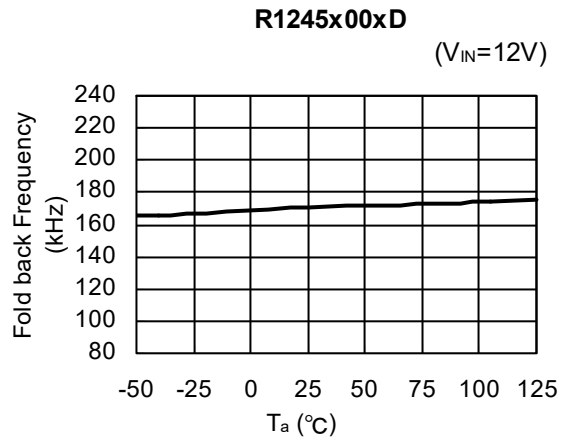
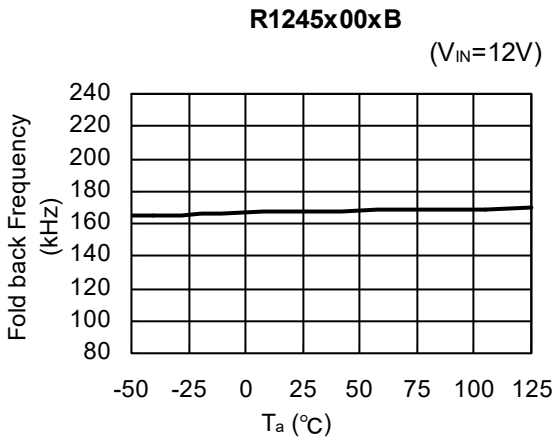

6) High side switch current limit vs. Temperature

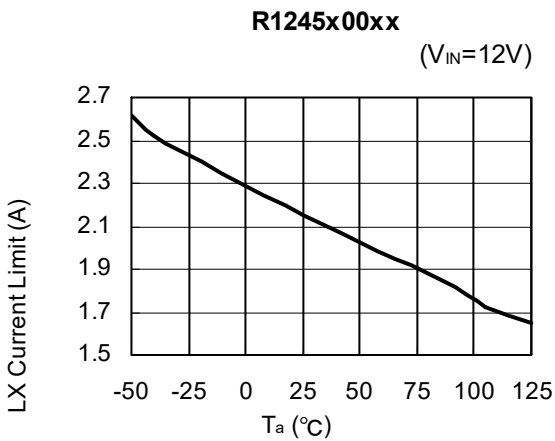

7) UVLO detector threshold vs. Temperature

R1245x00xx

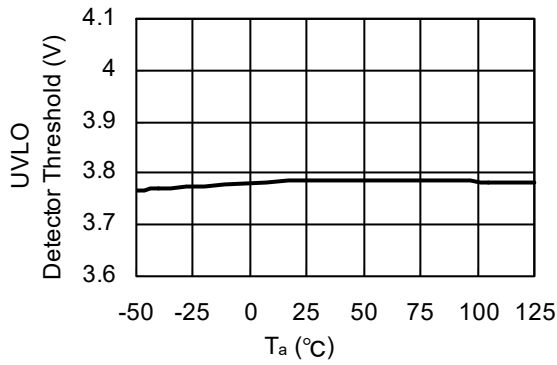

8) UVLO released voltage vs. Temperature

R1245x00xx

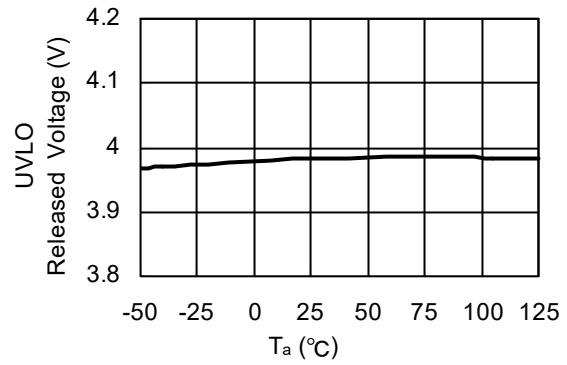

9) Soft-start time vs. Temperature

R1245x00xx

(V_{IN}=12V)

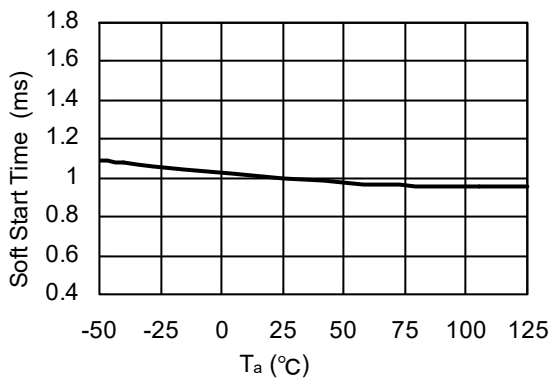

10) Timer latch delay vs. Temperature

R1245x00xx

(V_{IN}=6V)

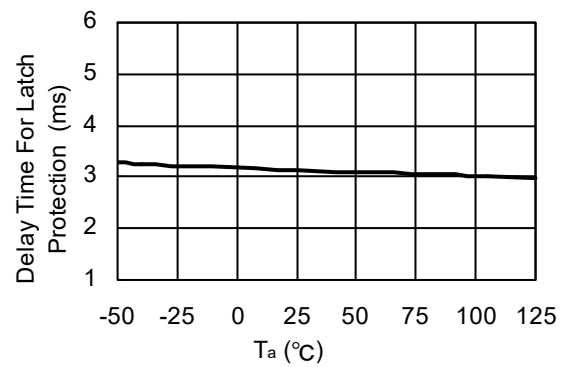

11) CE "H" Input voltage vs. Temperature

R1245x00xx

(V_{IN}=12V)

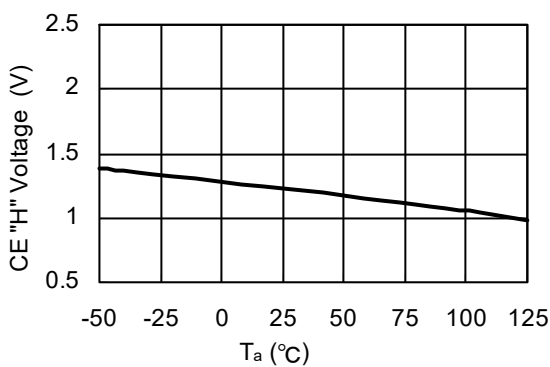

12) CE "L" Input voltage vs. Temperature

R1245x00xx

(V_{IN}=12V)

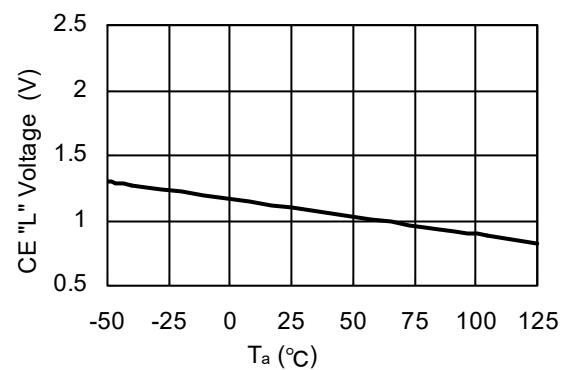

R1245x

No. EA-269-201022

13) Soft-start waveform

R1245x00xA/R1245x00xB

$V_{OUT}=3.3V$, $V_{IN}=12V$, $I_{OUT}=0mA$, $T_a=25^\circ C$

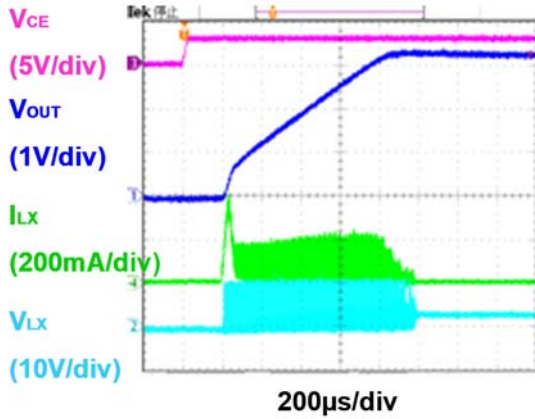

R1245x00xA/R1245x00xB

$V_{OUT}=3.3V$, $V_{IN}=12V$, $I_{OUT}=600mA$, $T_a=25^\circ C$

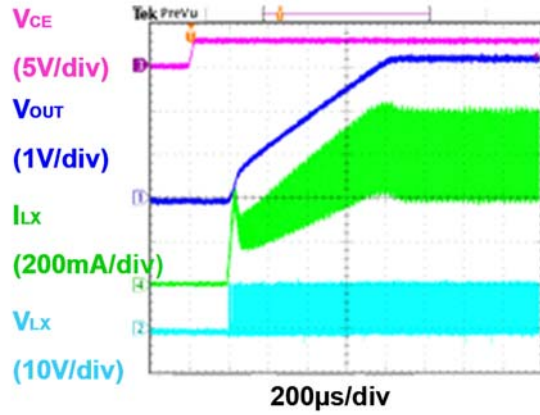

14) Switching operation waveform

R1245x00xA/R1245x00xB

$V_{OUT}=3.3V$, $V_{IN}=12V$, $I_{OUT}=0mA$, $T_a=25^\circ C$

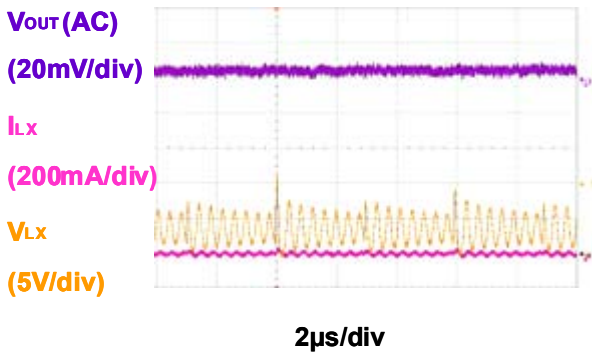

R1245x00xA/R1245x00xB

$V_{OUT}=3.3V$, $V_{IN}=12V$, $I_{OUT}=600mA$, $T_a=25^\circ C$

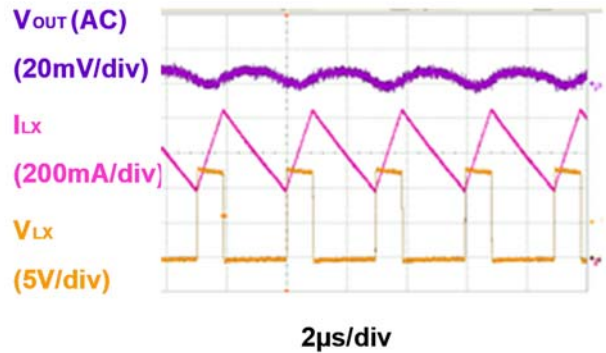

R1245x00xG/R1245x00xH

$V_{OUT}=3.3V$, $V_{IN}=12V$, $I_{OUT}=20mA$, $T_a=25^\circ C$

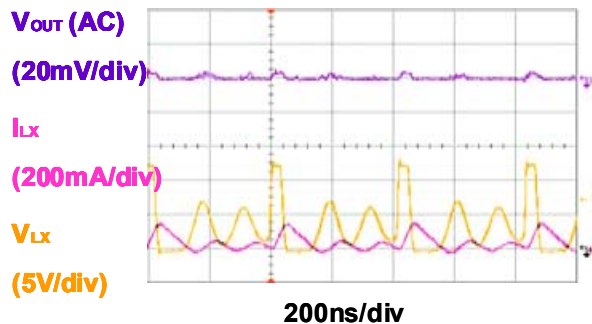

R1245x00xG/R1245x00xH

$V_{OUT}=3.3V$, $V_{IN}=12V$, $I_{OUT}=600mA$, $T_a=25^\circ C$

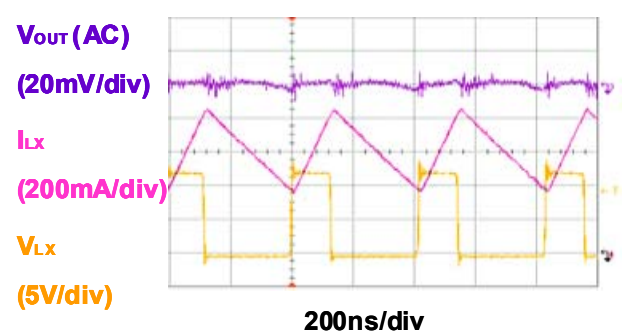

15) Load transient response waveform

R1245x00xA/R1245x00xB

$V_{OUT}=0.8V$, $V_{IN}=12V$, $I_{OUT}=600\leftrightarrow 1200mA$, $T_a=25^{\circ}C$

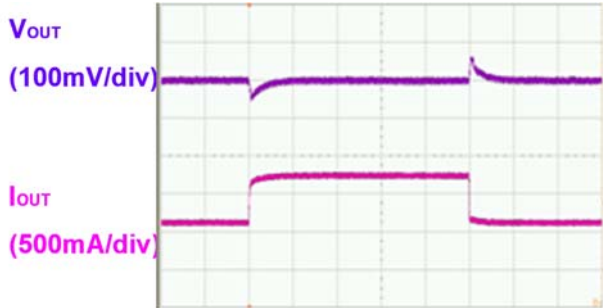

100 μ s/div

R1245x00XA/R1245x00xB

$V_{OUT}=3.3V$, $V_{IN}=12V$, $I_{OUT}=600\leftrightarrow 1200mA$, $T_a=25^{\circ}C$

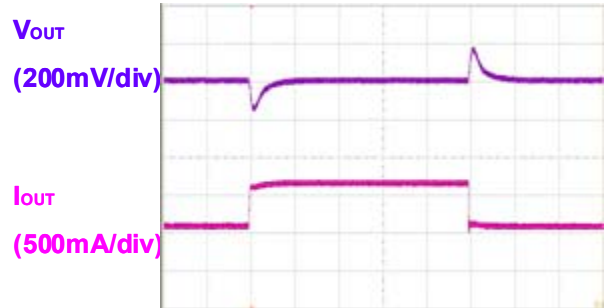

100 μ s/div

R1245x00xG/R1245x00xH

$V_{OUT}=1.5V$, $V_{IN}=4.5V$, $I_{OUT}=600\leftrightarrow 1200mA$, $T_a=25^{\circ}C$

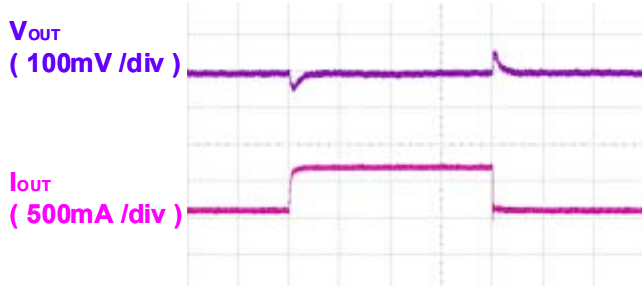

50us/div

R1245x00xG/R1245x00xH

$V_{OUT}=3.3V$, $V_{IN}=12V$, $I_{OUT}=600\leftrightarrow 1200mA$, $T_a=25^{\circ}C$

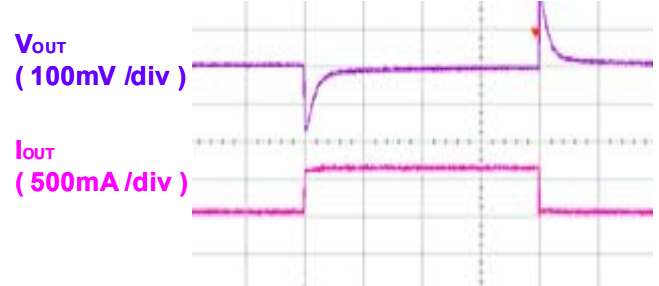

50us/div

R1245x

No. EA-269-201022

16) Limit latch operation waveform

R1245x00xA

$V_{OUT}=3.3V$, $V_{IN}=12V$, $R_{OUT}=5.5\Omega \rightarrow 0.05\Omega$, $T_a=25^\circ C$

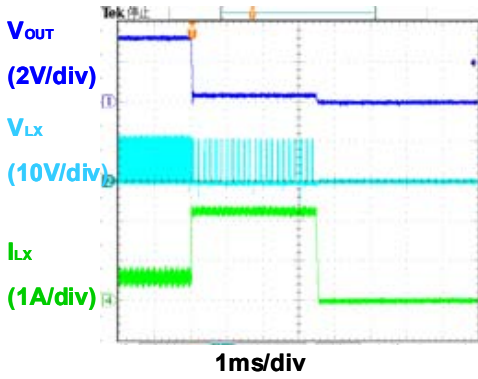

17) Released waveform from limit latch

R1245x00xA

$V_{OUT}=3.3V$, $V_{IN}=12V$, $R_{OUT}=5.5\Omega \rightarrow 0.05\Omega \rightarrow 5.5\Omega$, $T_a=25^\circ C$

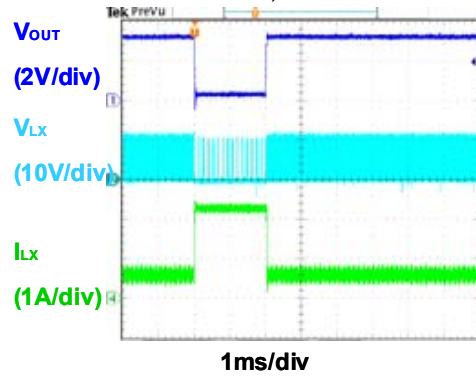

18) Fold back operation waveform

R1245x00xB

$V_{OUT}=3.3V$, $V_{IN}=12V$, $R_{OUT}=5.5\Omega \rightarrow 0.05\Omega$, $T_a=25^\circ C$

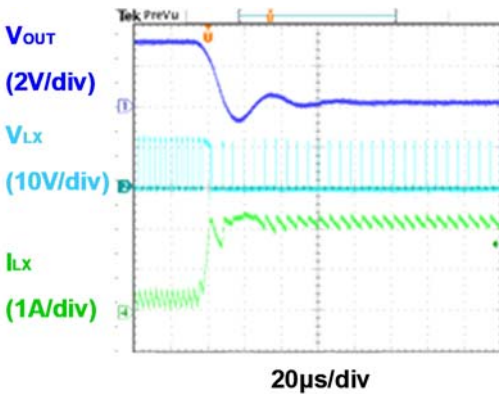

19) Released waveform from fold back

R1245x00xB

$V_{OUT}=3.3V$, $V_{IN}=12V$, $R_{OUT}=5.5\Omega \rightarrow 0.05\Omega \rightarrow 5.5\Omega$, $T_a=25^\circ C$

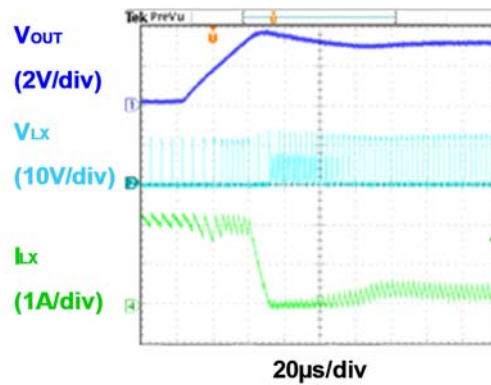

20) Switching waveform at fold back operation

R1245x00xB

$V_{OUT}=3.3V$, $V_{IN}=12V$, $R_{OUT}=0.05\Omega$, $T_a=25^\circ C$

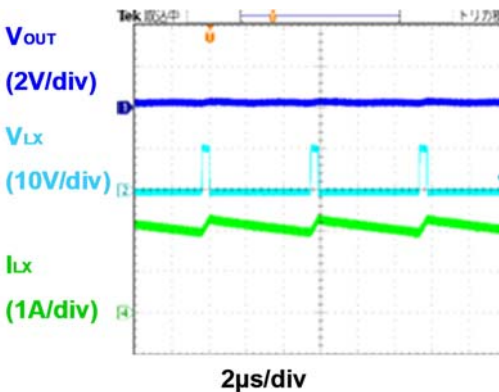

21) Output current vs. Efficiency (Version A/B)

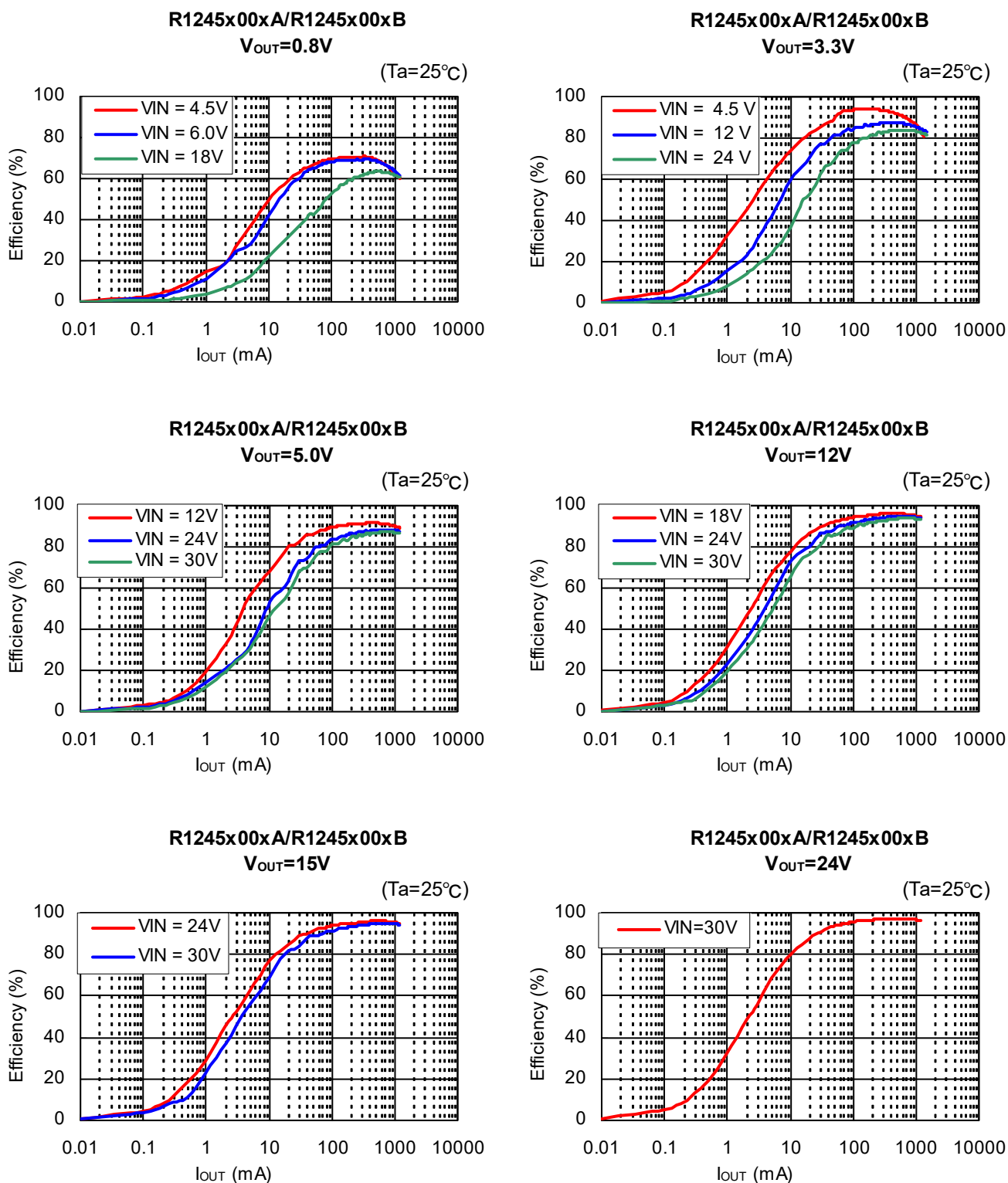

R1245x

No. EA-269-201022

22) Output Current vs. Efficiency (Version C/D)

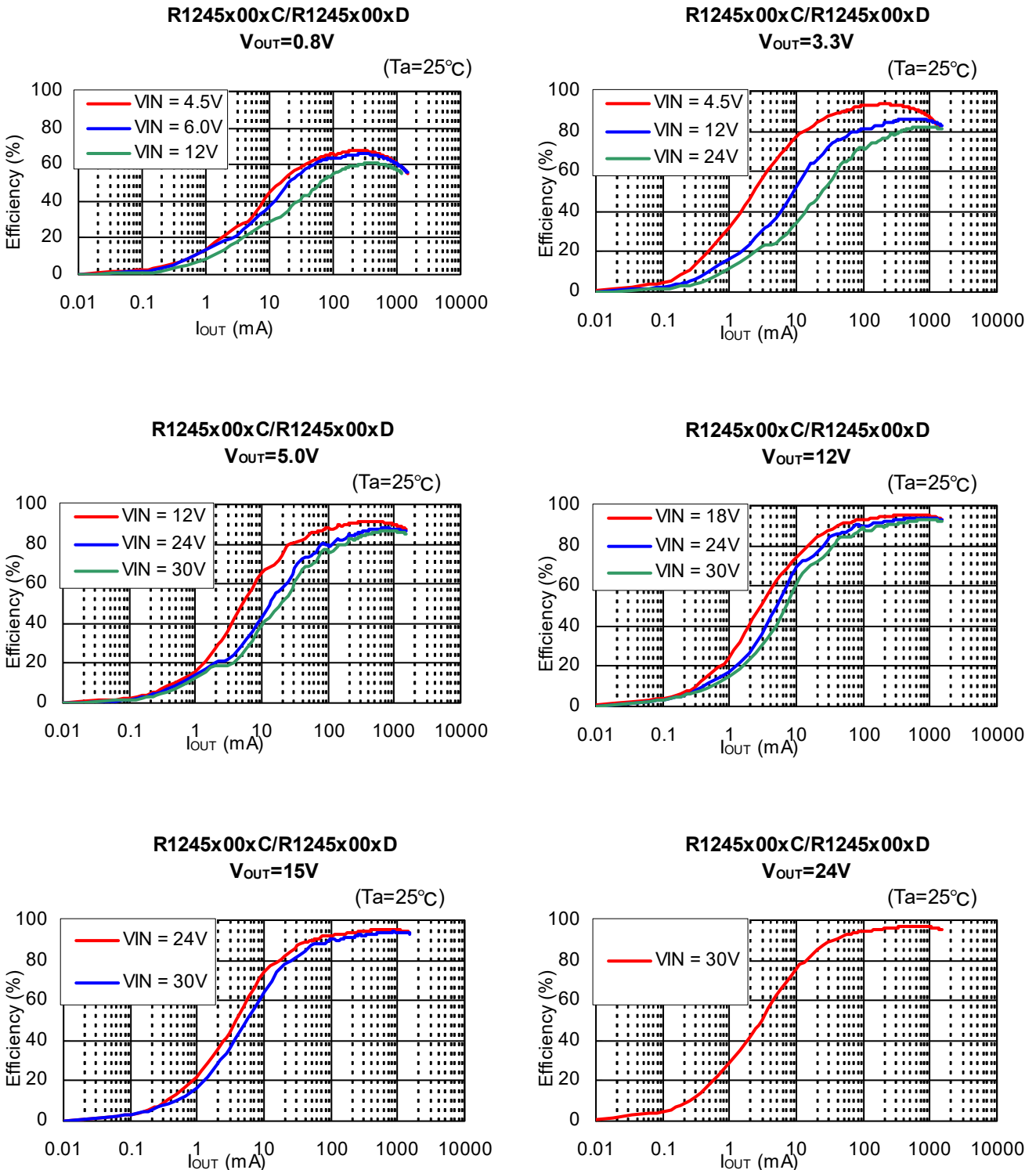

23) Output current vs. Efficiency (Version E/F)

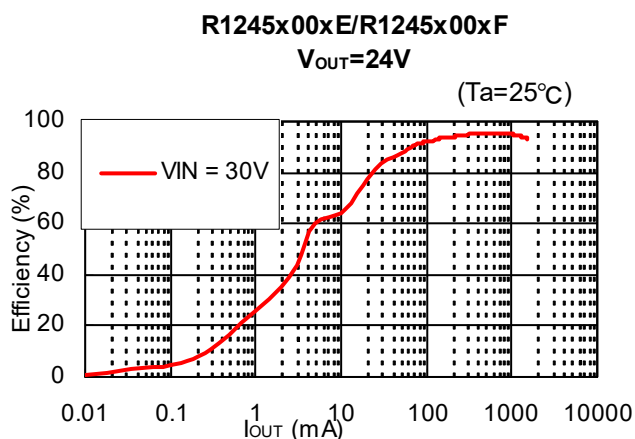
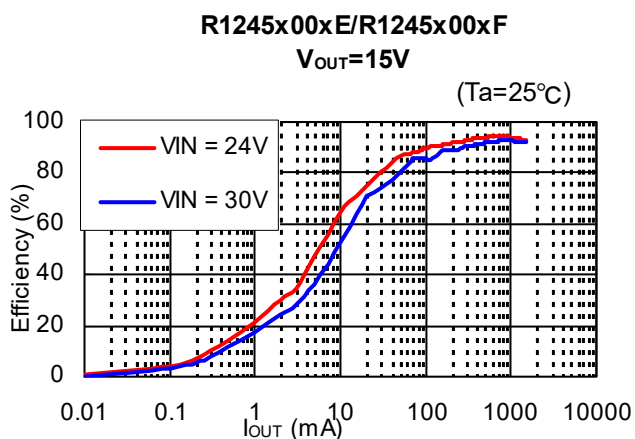
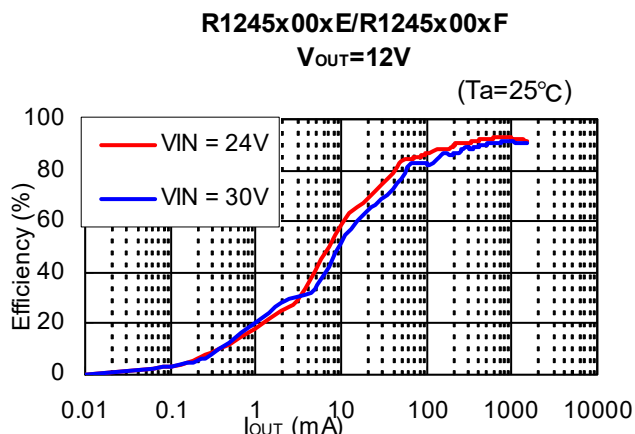
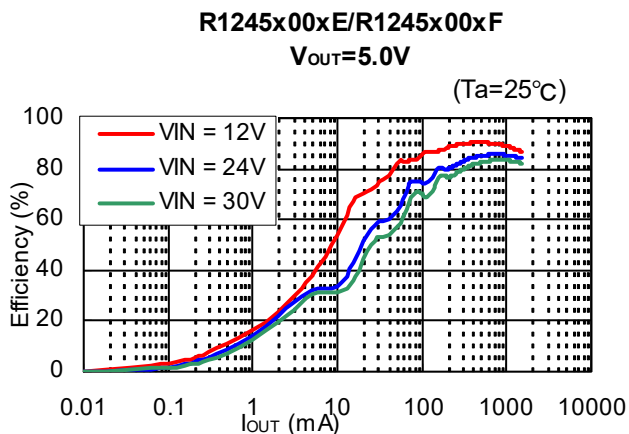
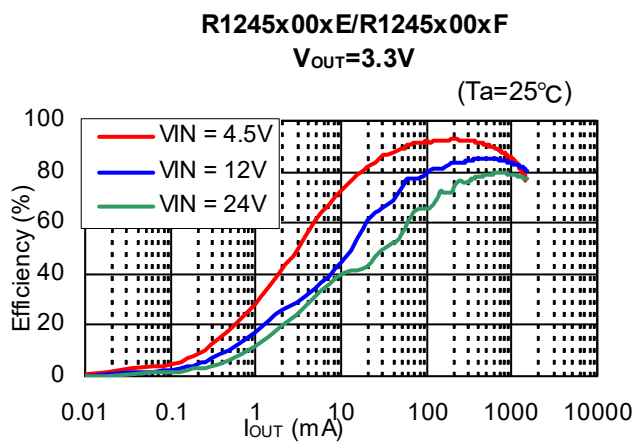
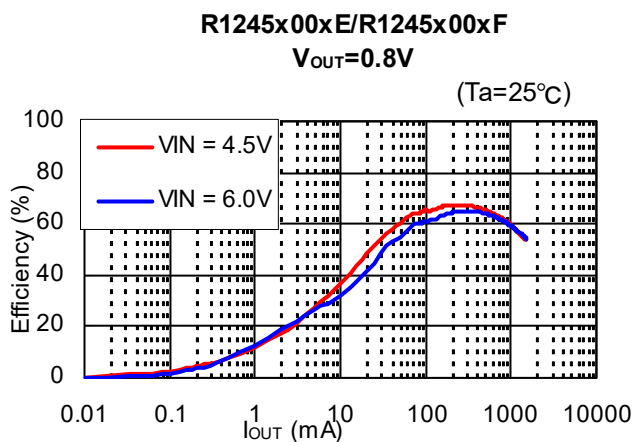

R1245x

No. EA-269-201022

24) Output current vs. Efficiency (Version G/H)

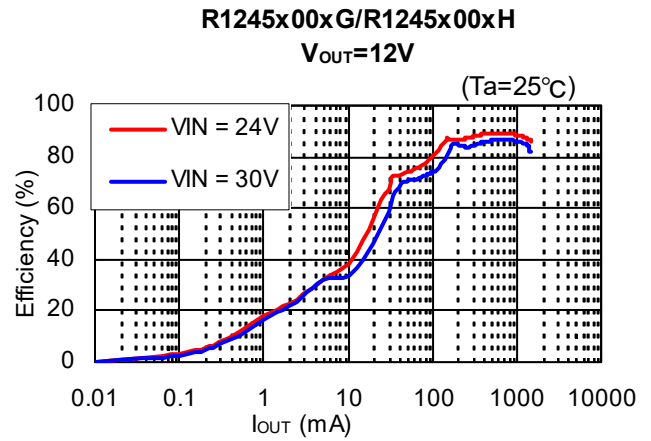
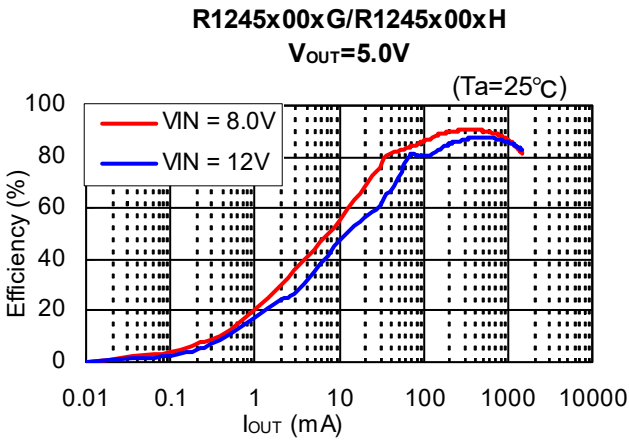
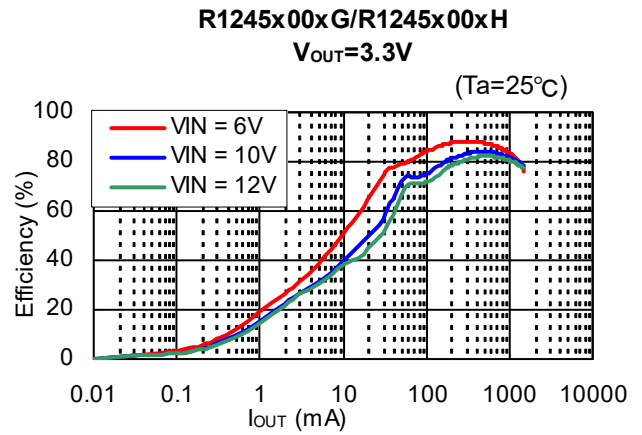
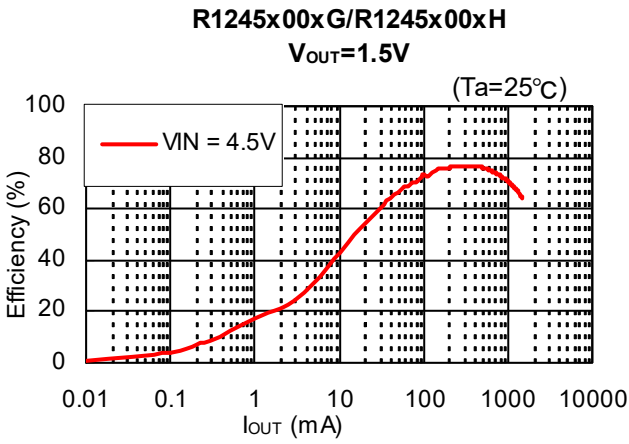

25) Output current vs Output voltage (Version A/B)

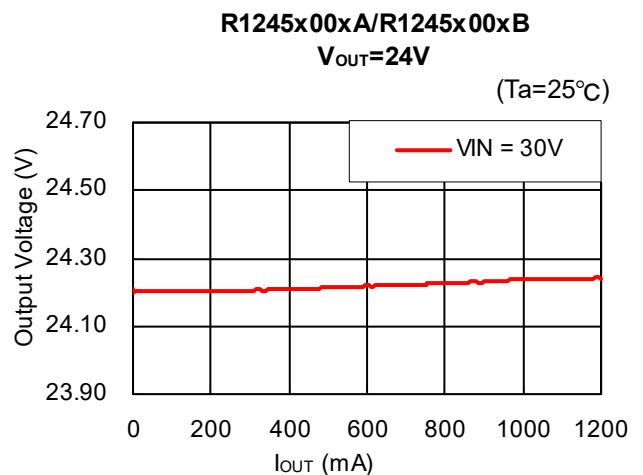
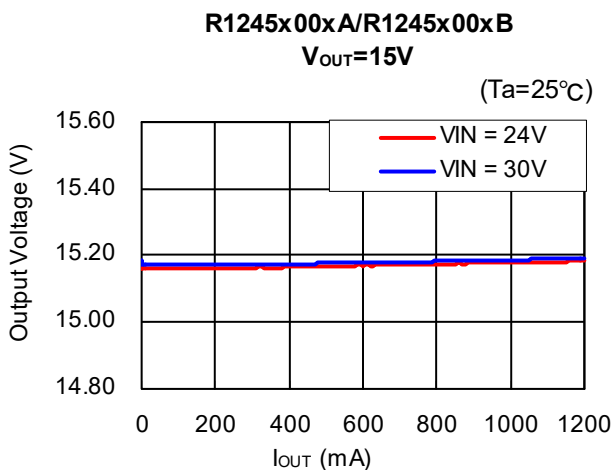
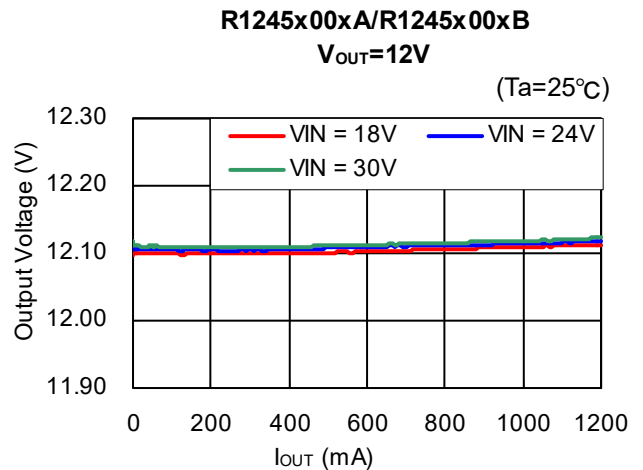
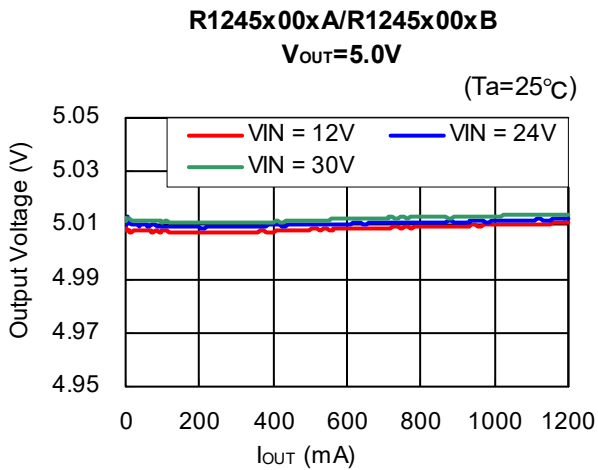
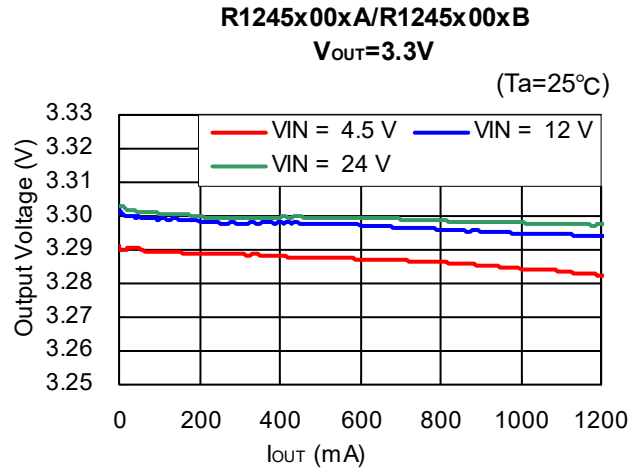
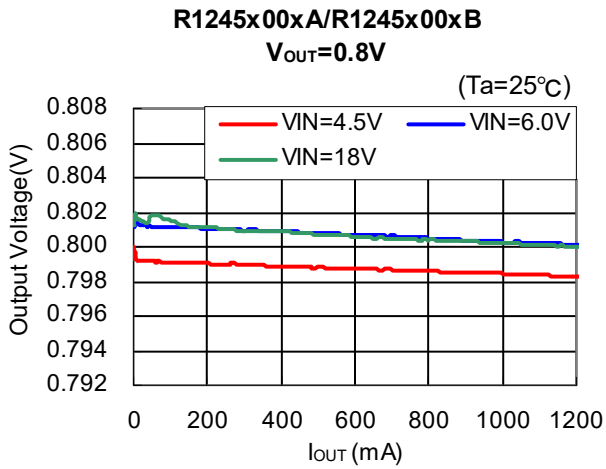

R1245x

No. EA-269-201022

26) Output current vs. Output voltage (Version C/D)

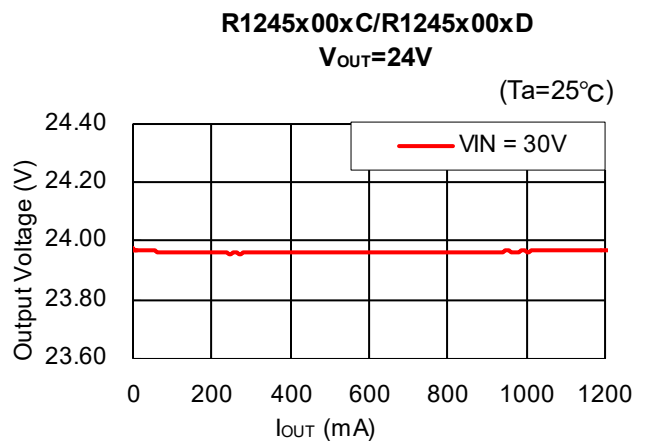
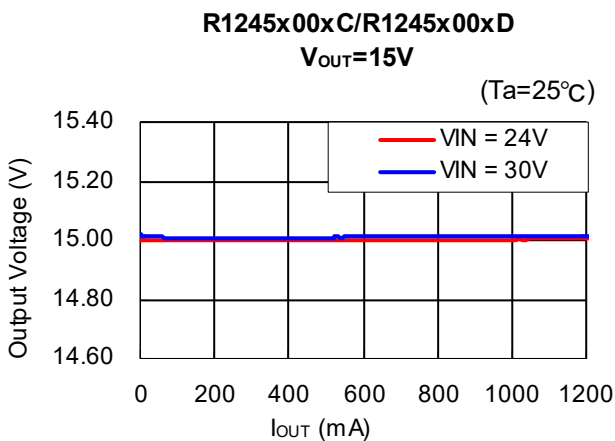
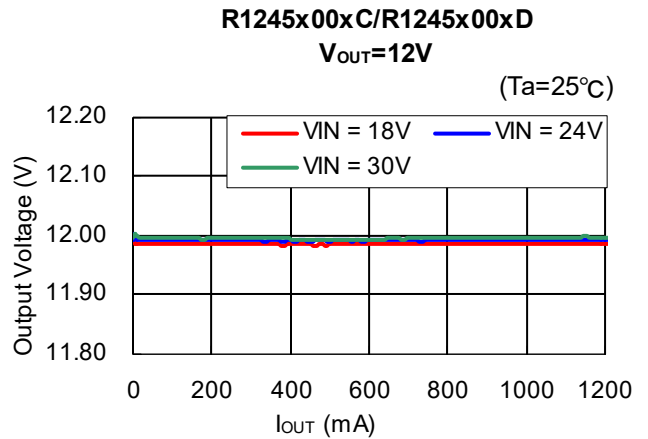
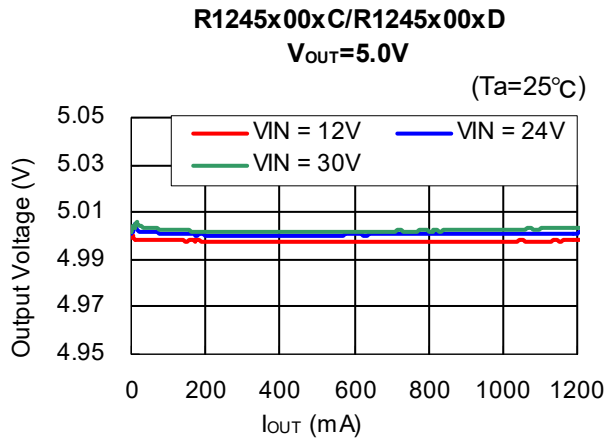
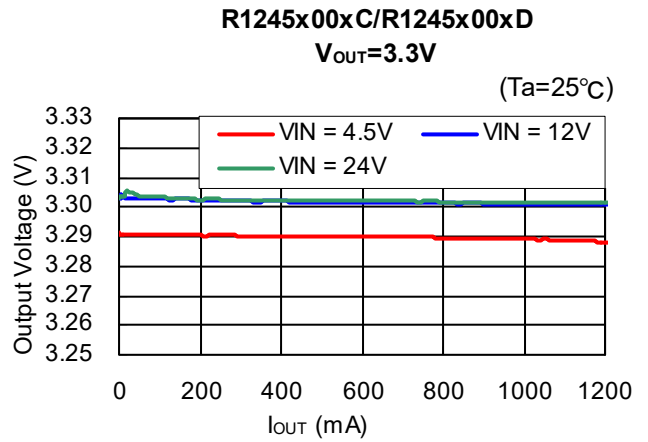
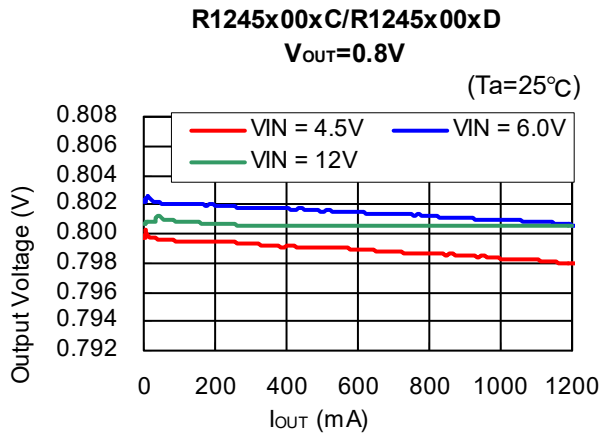

27) Output current vs. Output voltage (Version E/F)

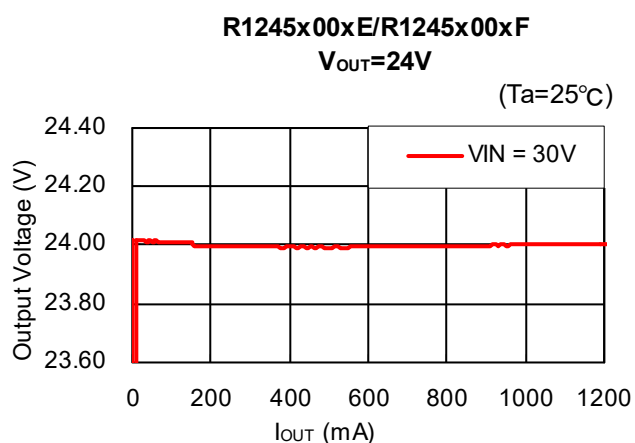
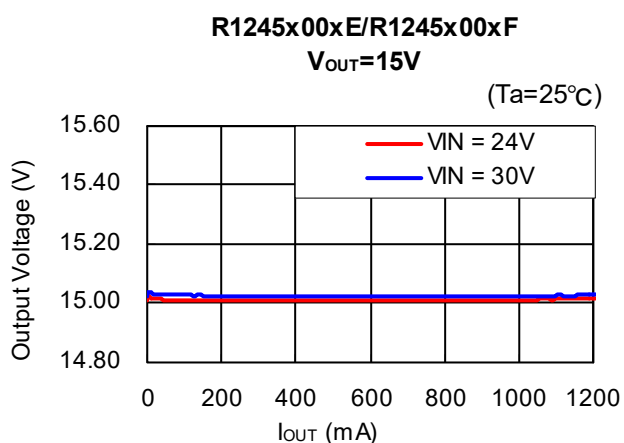
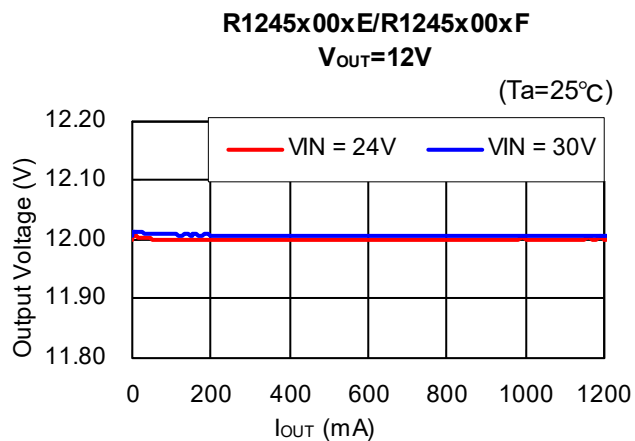
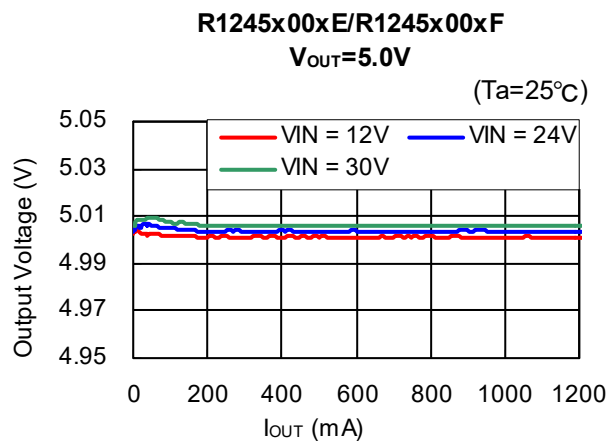
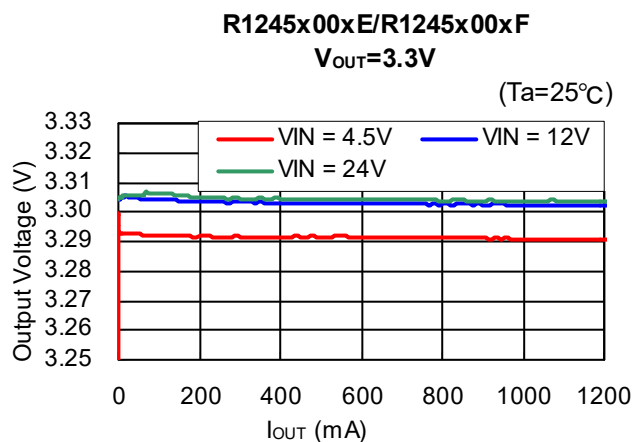
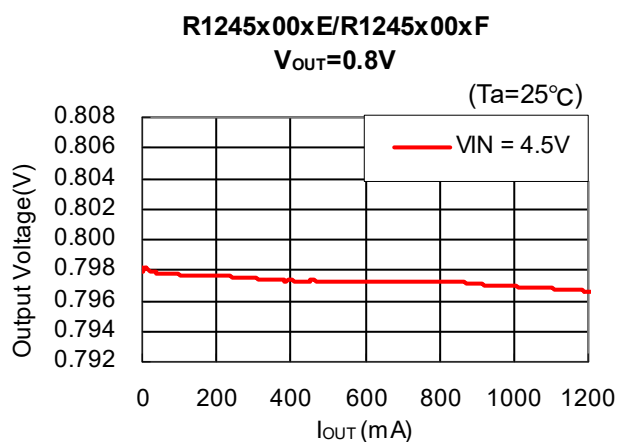

R1245x

No. EA-269-201022

28) Output current vs. Output voltage (Version G/H)

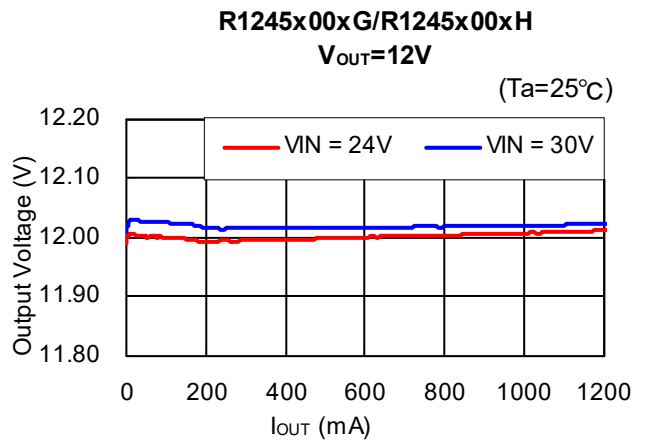
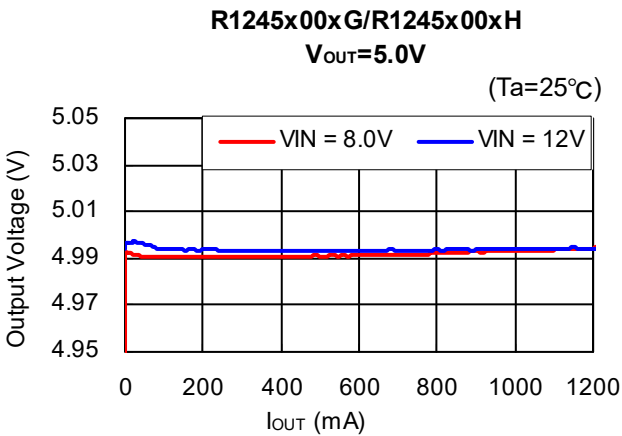
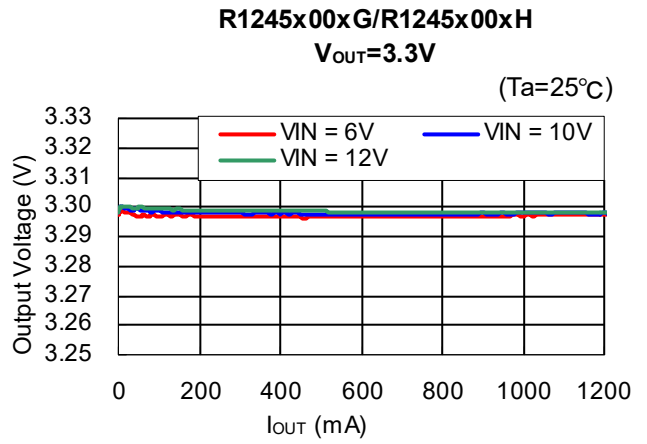
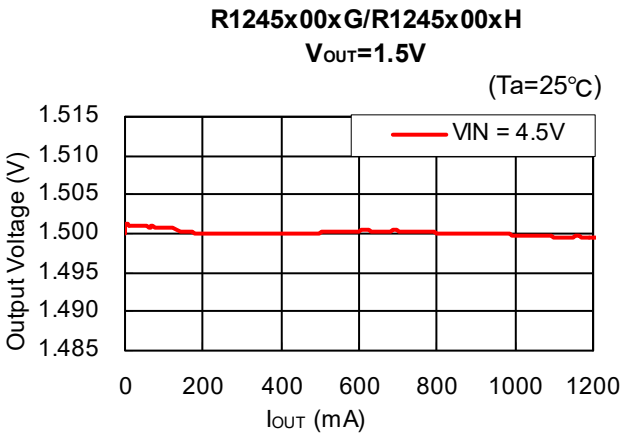

29) Input voltage vs. Output voltage (Version A/B)

R1245x00xA/R1245x00xB

$V_{OUT}=0.8V$

($T_a=25^\circ C$)

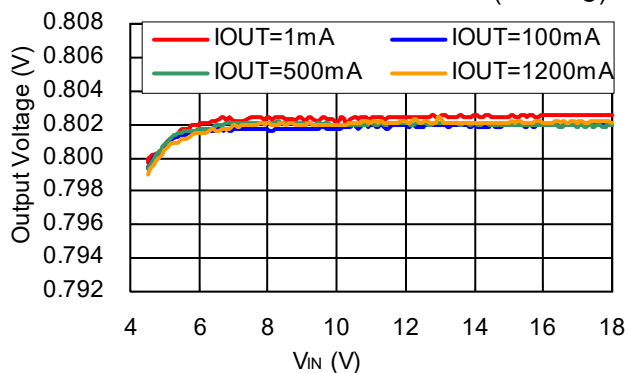

R1245x00xA/R1245x00xB

$V_{OUT}=3.3V$

($T_a=25^\circ C$)

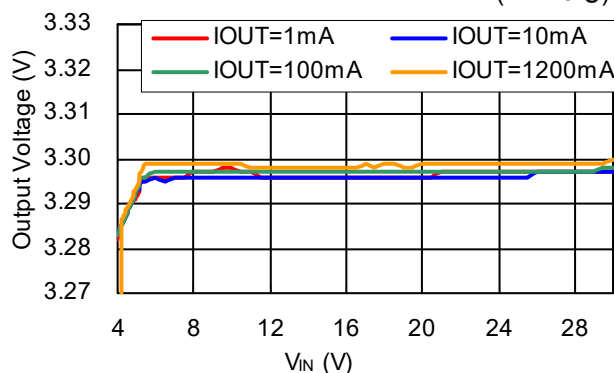

R1245x00xA/R1245x00xB

$V_{OUT}=5.0V$

($T_a=25^\circ C$)

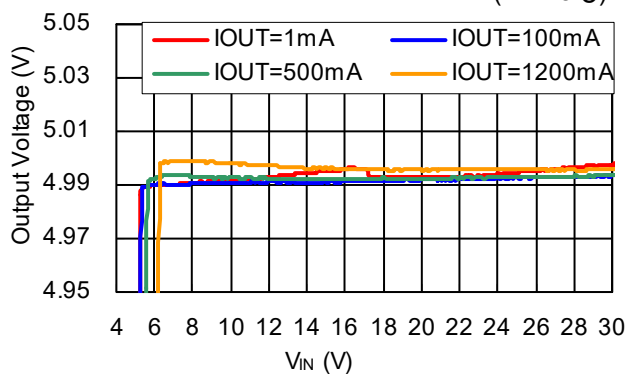

R1245x00xA/R1245x00xB

$V_{OUT}=12V$

($T_a=25^\circ C$)

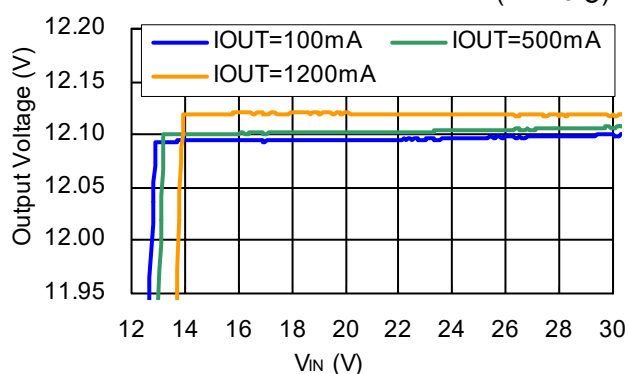

R1245x00xA/R1245x00xB

$V_{OUT}=15V$

($T_a=25^\circ C$)

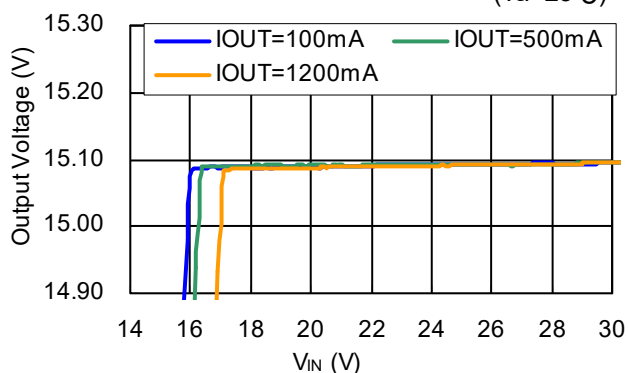

R1245x00xA/R1245x00xB

$V_{OUT}=24V$

($T_a=25^\circ C$)

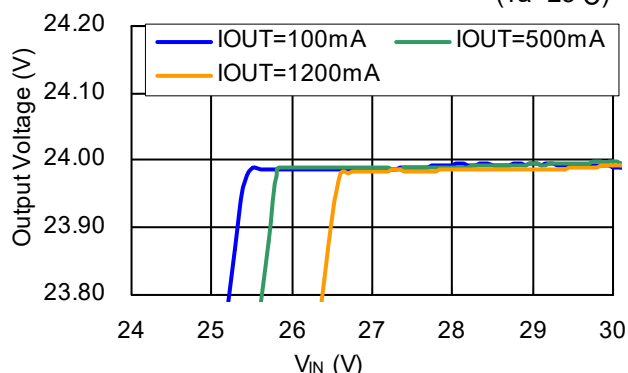

R1245x

No. EA-269-201022

30) Input voltage vs. Output voltage (Version C/D)

R1245x00xC/R1245x00xD
 $V_{OUT}=0.8V$

($T_a=25^\circ C$)

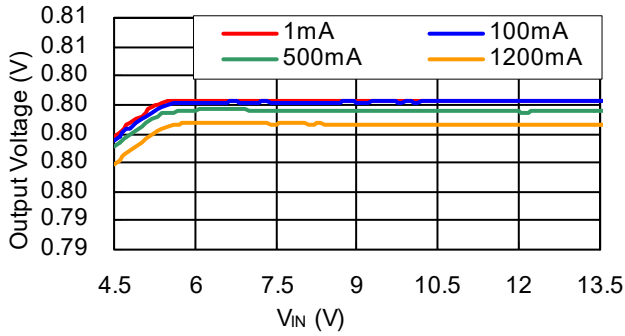

R1245x00xC/R1245x00xD
 $V_{OUT}=3.3V$

($T_a=25^\circ C$)

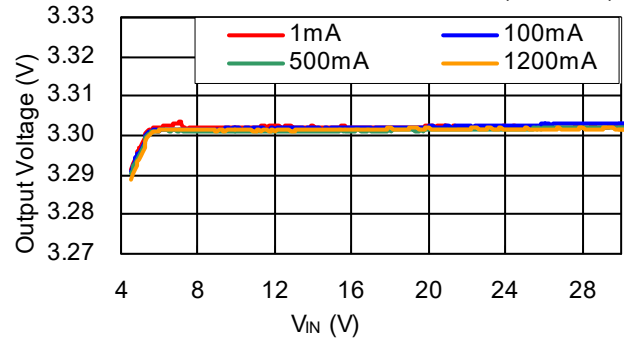

R1245x00xC/R1245x00xD
 $V_{OUT}=5.0V$

($T_a=25^\circ C$)

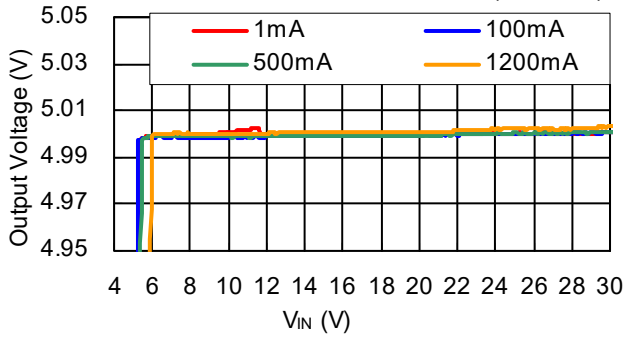

R1245x00xC/R1245x00xD
 $V_{OUT}=12V$

($T_a=25^\circ C$)

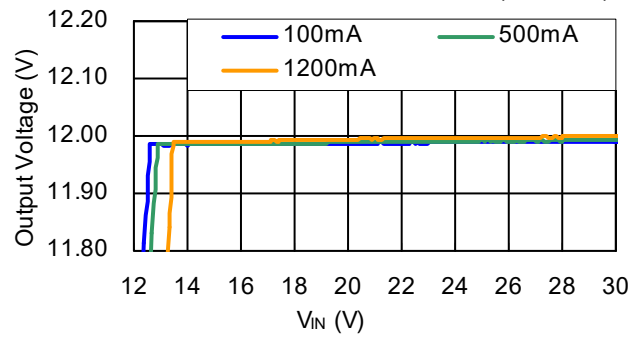

R1245x00xC/R1245x00xD
 $V_{OUT}=15V$

($T_a=25^\circ C$)

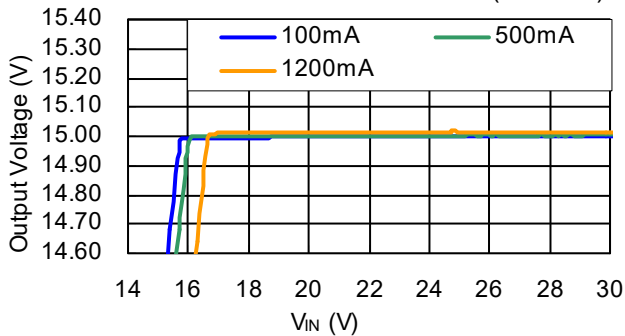

R1245x00xC/R1245x00xD
 $V_{OUT}=24V$

($T_a=25^\circ C$)

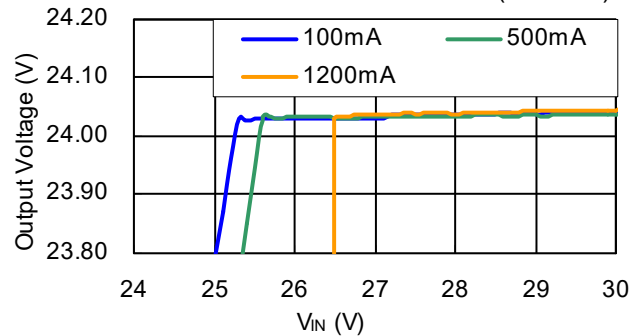

31) Input voltage vs. Output voltage (Version E/F)

R1245x00xE/R1245x00xF
V_{OUT}=0.8V

(Ta=25°C)

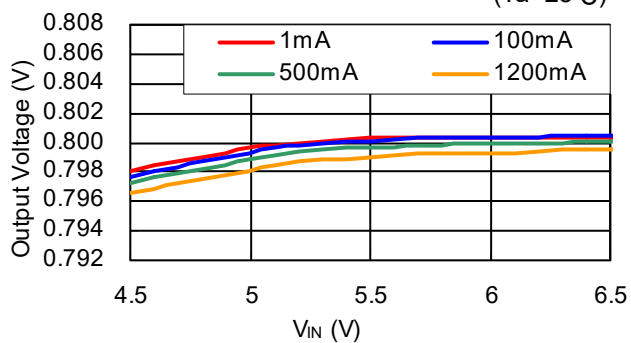

R1245x00xE/R1245x00xF
V_{OUT}=3.3V

(Ta=25°C)

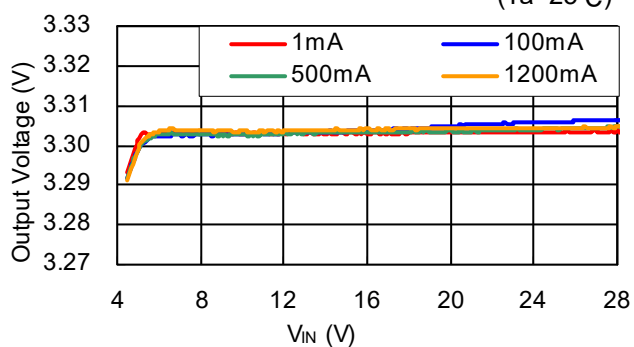

R1245x00xE/R1245x00xF
V_{OUT}=5.0V

(Ta=25°C)

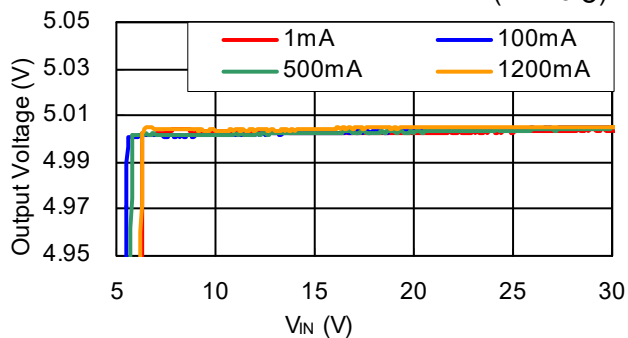

R1245x00xE/R1245x00xF
V_{OUT}=12V

(Ta=25°C)

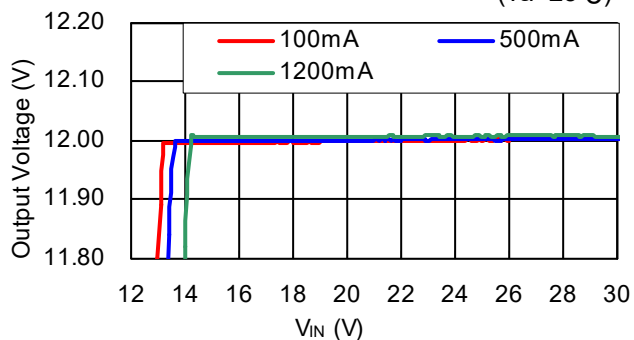

R1245x00xE/R1245x00xF
V_{OUT}=15V

(Ta=25°C)

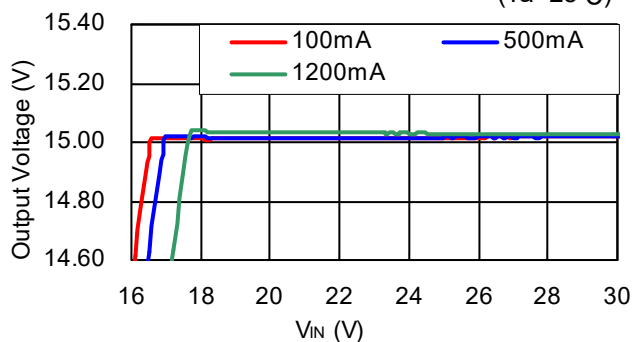

R1245x00xE/R1245x00xF
V_{OUT}=24V

(Ta=25°C)

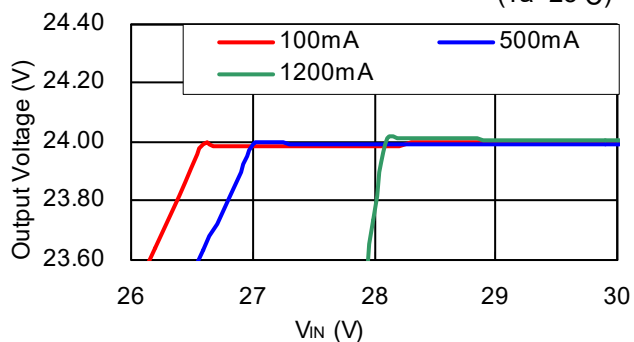

R1245x

No. EA-269-201022

32) Input voltage vs. Output voltage (Version G/H)

R1245x00xG/R1245x00xH
V_{OUT}=1.5V

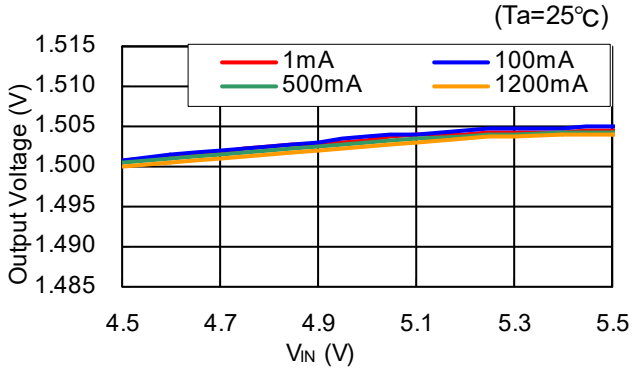

R1245x00xG/R1245x00xH
V_{OUT}=3.3V

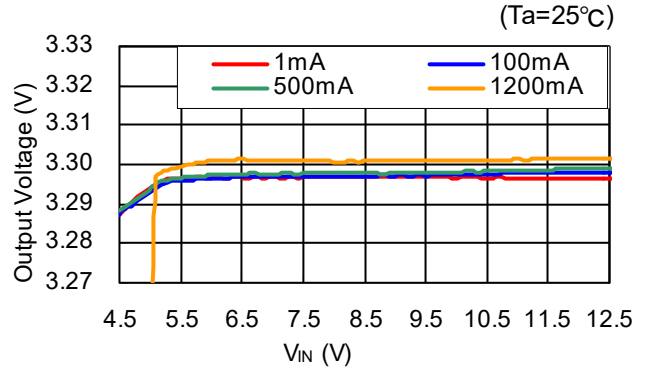

R1245x00xG/R1245x00xH
V_{OUT}=5.0V

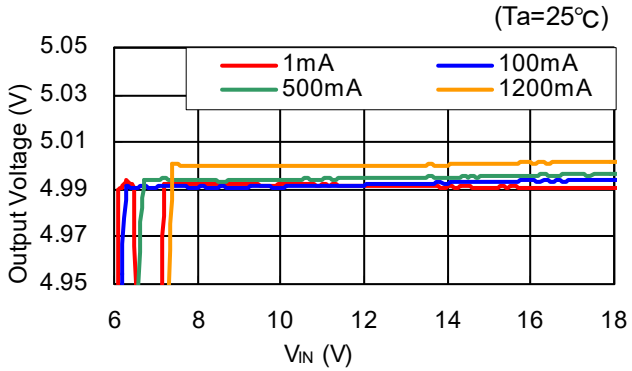

R1245x00xG/R1245x00xH
V_{OUT}=12V

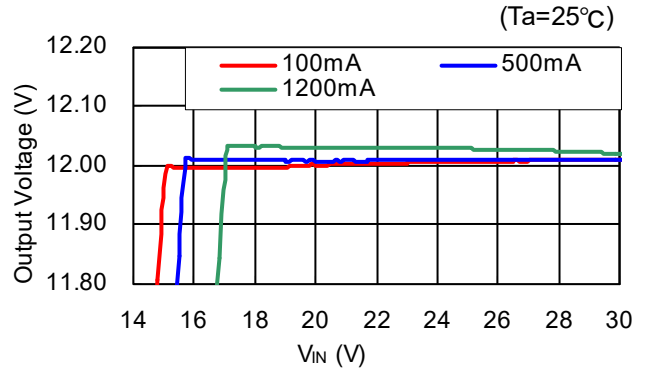

The power dissipation of the package is dependent on PCB material, layout, and environmental conditions. The following conditions are used in this measurement.

Measurement Conditions

Ultra-High Wattage Land Pattern	
Environment	Mounting on Board (Wind Velocity = 0 m/s)
Board Material	Glass Cloth Epoxy Plastic (Four-Layer Board)
Board Dimensions	76.2 mm × 114.3 mm × 0.8 mm
Copper Ratio	Outer Layers (First and Fourth Layers): Approx. 95% of 50 mm Square Inner Layers (Second and Third Layers): Approx. 100% of 50 mm Square
Through-holes	φ 0.4 mm × 21 pcs

Measurement Result

(Ta = 25°C, Tjmax = 125°C)

Ultra-High Wattage Land Pattern	
Power Dissipation	2.9 W
Thermal Resistance	$\theta_{ja} = (125 - 25^\circ\text{C}) / 2.9 \text{ W} = 35^\circ\text{C/W}$ $\theta_{jc} = 10^\circ\text{C/W}$

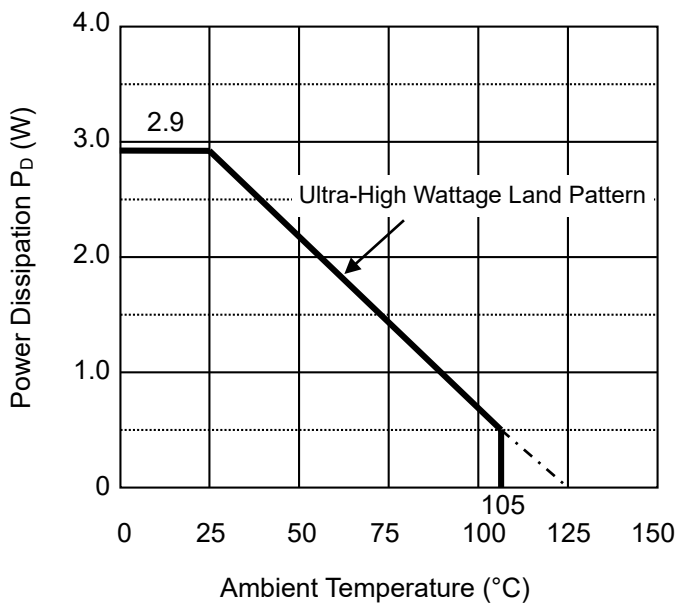

Power Dissipation vs. Ambient Temperature

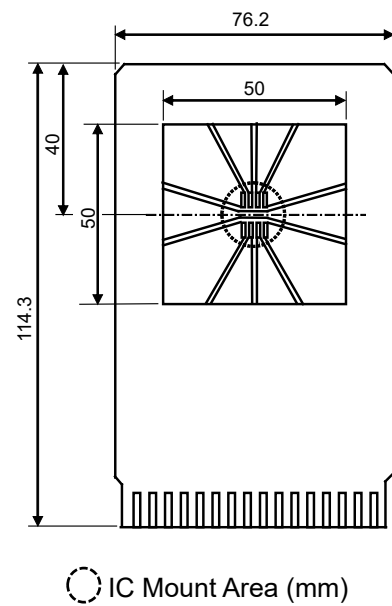

Measurement Board Pattern

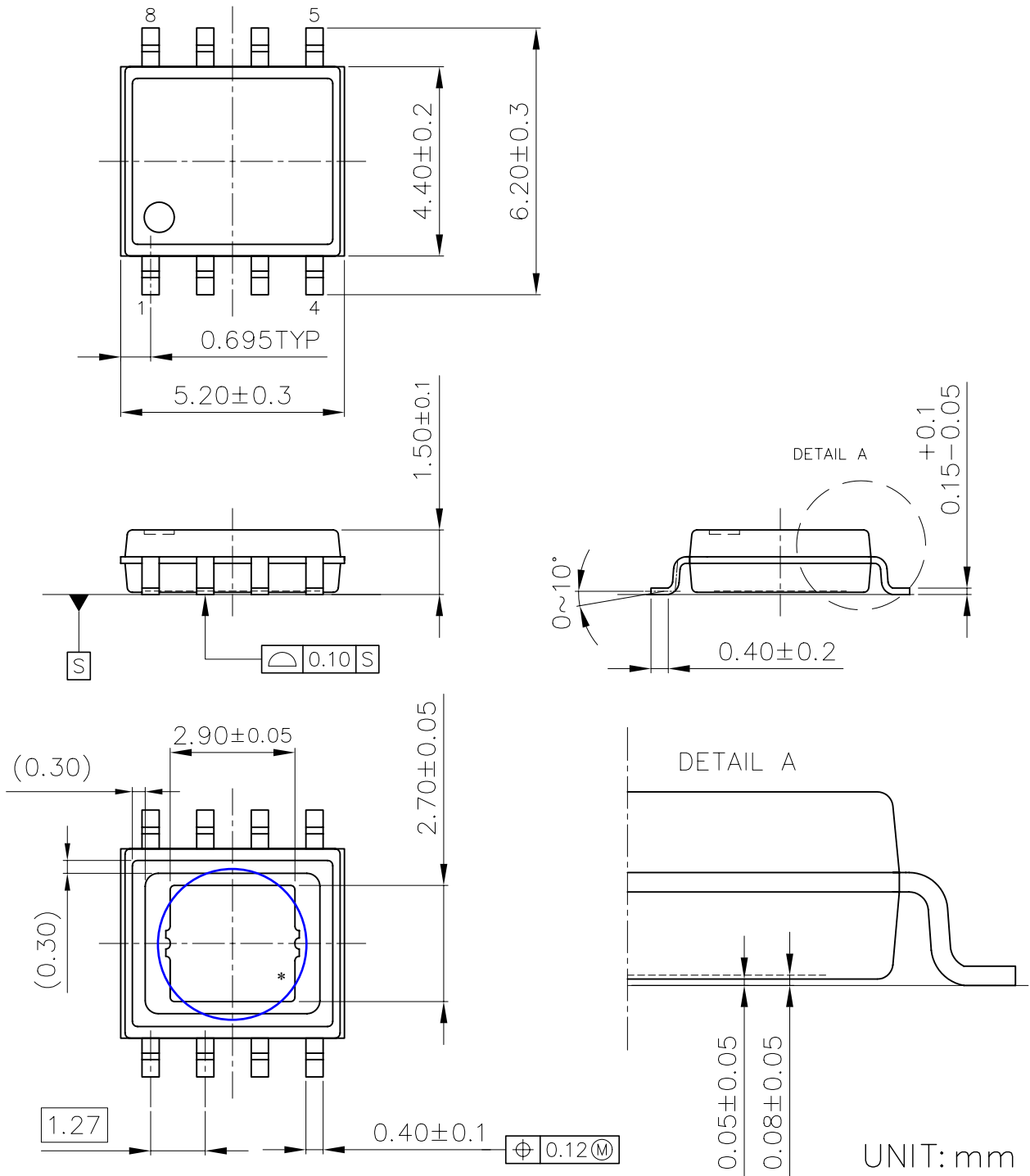

HSOP-8E Package Dimensions

* The tab on the bottom of the package shown by blue circle is substrate potential (GND/V_{DD}). It is recommended that this tab be connected to the ground plane/V_{DD} pin on the board but it is possible to leave the tab floating.

The power dissipation of the package is dependent on PCB material, layout, and environmental conditions. The following conditions are used in this measurement.

Measurement Conditions

	Standard Test Land Pattern
Environment	Mounting on Board (Wind Velocity = 0 m/s)
Board Material	Glass Cloth Epoxy Plastic (Double-Sided Board)
Board Dimensions	40 mm × 40 mm × 1.6 mm
Copper Ratio	Top Side: Approx. 50% Bottom Side: Approx. 50%
Through-holes	φ 0.54 mm × 30 pcs

Measurement Result

(Ta = 25°C, Tjmax = 125°C)

	Standard Test Land Pattern
Power Dissipation	880 mW
Thermal Resistance	$\theta_{ja} = (125 - 25^\circ\text{C}) / 0.88 \text{ W} = 114^\circ\text{C/W}$

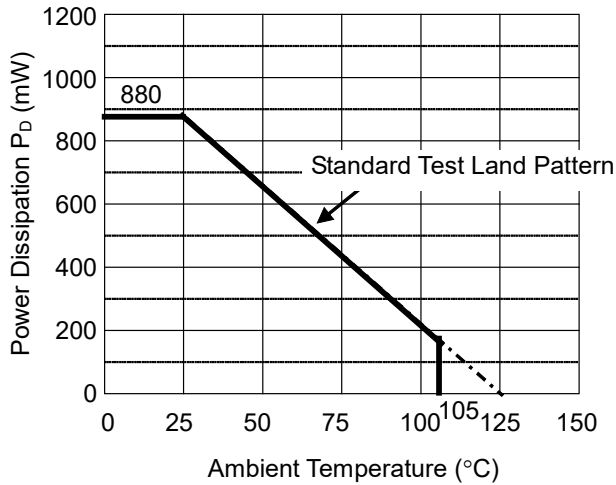

Power Dissipation vs. Ambient Temperature

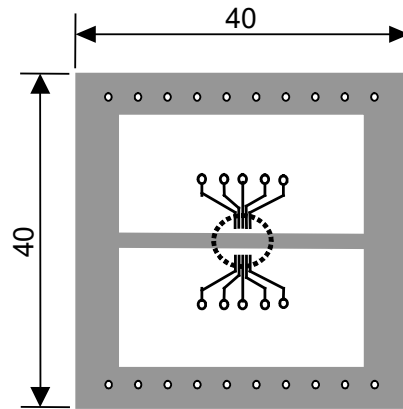

○ IC Mount Area (mm)

Measurement Board Pattern

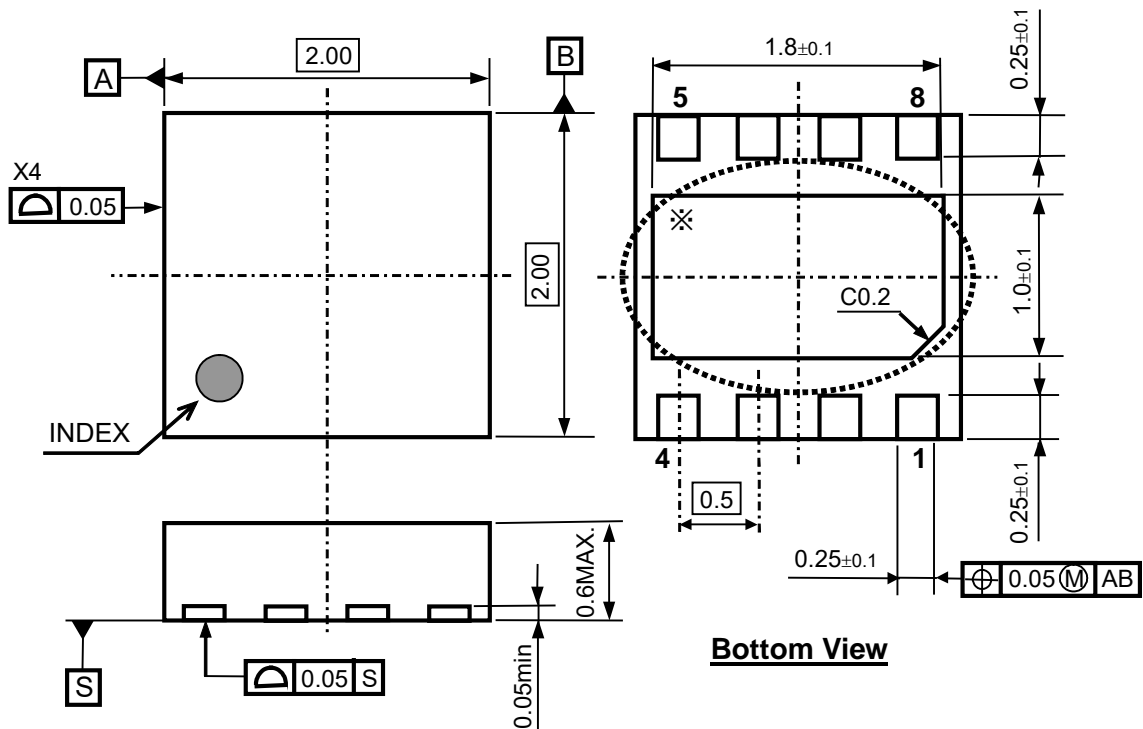

DFN (PL) 2020-8 Package Dimensions (Unit: mm)

* The tab on the bottom of the package is substrate level (GND). It is recommended that the tab be connected to the ground plane on the board, or otherwise be left floating.

The power dissipation of the package is dependent on PCB material, layout, and environmental conditions. The following conditions are used in this measurement.

Measurement Conditions

	Standard Test Land Pattern
Environment	Mounting on Board (Wind Velocity = 0 m/s)
Board Material	Glass Cloth Epoxy Plastic (Double-Sided Board)
Board Dimensions	40 mm × 40 mm × 1.6 mm
Copper Ratio	Top Side: Approx. 50% Bottom Side: Approx. 50%
Through-holes	φ 0.5 mm × 44 pcs

Measurement Result

(Ta = 25°C, Tjmax = 125°C)

	Standard Test Land Pattern
Power Dissipation	430 mW
Thermal Resistance	$\theta_{ja} = (125 - 25^\circ\text{C}) / 0.43 \text{ W} = 233^\circ\text{C/W}$

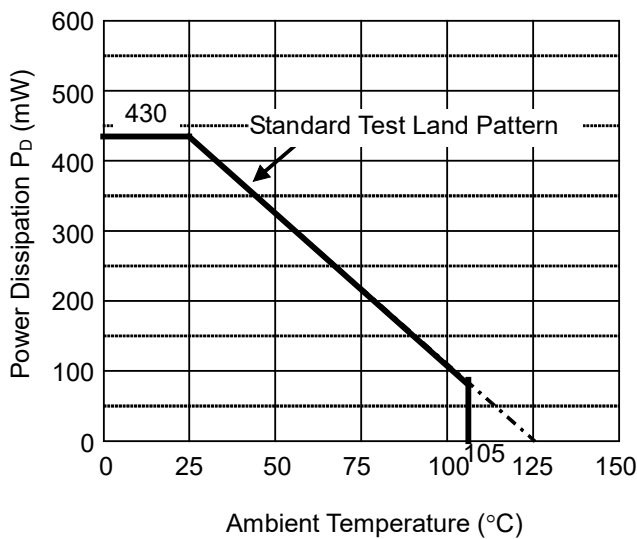

Power Dissipation vs. Ambient Temperature

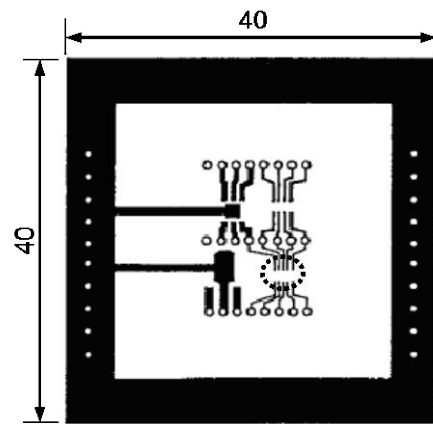

○ IC Mount Area (mm)

Measurement Board Pattern

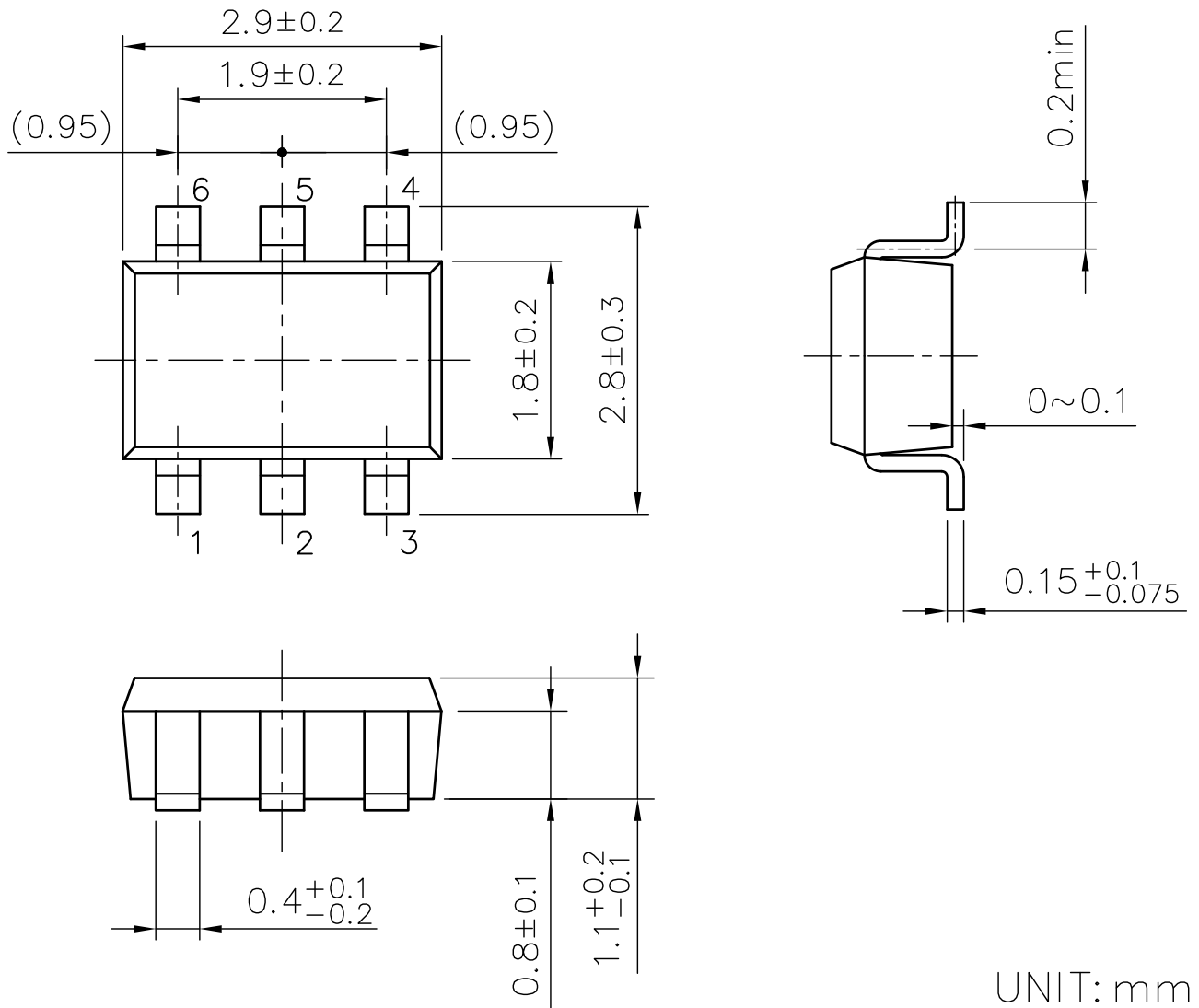

UNIT: mm

SOT-23-6W Package Dimensions (Unit: mm)



1. The products and the product specifications described in this document are subject to change or discontinuation of production without notice for reasons such as improvement. Therefore, before deciding to use the products, please refer to our sales representatives for the latest information thereon.
2. The materials in this document may not be copied or otherwise reproduced in whole or in part without prior written consent of our company.
3. Please be sure to take any necessary formalities under relevant laws or regulations before exporting or otherwise taking out of your country the products or the technical information described herein.
4. The technical information described in this document shows typical characteristics of and example application circuits for the products. The release of such information is not to be construed as a warranty of or a grant of license under our company's or any third party's intellectual property rights or any other rights.
5. The products listed in this document are intended and designed for use as general electronic components in standard applications (office equipment, telecommunication equipment, measuring instruments, consumer electronic products, amusement equipment etc.). Those customers intending to use a product in an application requiring extreme quality and reliability, for example, in a highly specific application where the failure or misoperation of the product could result in human injury or death (aircraft, spacevehicle, nuclear reactor control system, traffic control system, automotive and transportation equipment, combustion equipment, safety devices, life support system etc.) should first contact us.
6. We are making our continuous effort to improve the quality and reliability of our products, but semiconductor products are likely to fail with certain probability. In order to prevent any injury to persons or damages to property resulting from such failure, customers should be careful enough to incorporate safety measures in their design, such as redundancy feature, fire containment feature and fail-safe feature. We do not assume any liability or responsibility for any loss or damage arising from misuse or inappropriate use of the products.
7. Anti-radiation design is not implemented in the products described in this document.
8. The X-ray exposure can influence functions and characteristics of the products. Confirm the product functions and characteristics in the evaluation stage.
9. WLCSP products should be used in light shielded environments. The light exposure can influence functions and characteristics of the products under operation or storage.
10. There can be variation in the marking when different AOI (Automated Optical Inspection) equipment is used. In the case of recognizing the marking characteristic with AOI, please contact our sales or our distributor before attempting to use AOI.
11. Please contact our sales representatives should you have any questions or comments concerning the products or the technical information.



Nisshinbo Micro Devices Inc.

Official website

<https://www.nisshinbo-microdevices.co.jp/en/>

Purchase information

<https://www.nisshinbo-microdevices.co.jp/en/buy/>

