



SPECIFICATION SHEET

SPECIFICATION SHEET NO.	P0115- TO277SB10S100L
DATE	Jan. 15, 2022
REVISION	A0
DESCRIPTION	SMD Schottky Barrier Rectifier, TO-277 series, SB10100L Type, Reverse Voltage 100V Max. Forward Current 10A Max. Operating Temp. Range -55°C ~+150°C, Package in Tape/Reel, 5000pcs/Reel RoHS/RoHS III compliant
CUSTOMER	
CUSTOMER PART NUMBER	
CROSS REF. PART NUMBER	
ORIGINAL PART NUMBER	MDD SB10100L
PART CODE	TO277SB10S100L

VENDOR APPROVE			
Issued/Checked/Approved			
DATE: Jan. 15, 2022			

CUSTOMER APPROVE	
DATE:	

1/16/2022

SMD SCHOTTKY BARRIER RECTIFIER TO-277 SERIES



MAIN FEATURE

- Plastic Material - UL Flammability Classification 94V-0
- Schottky Barrier Chip
- High Thermal Reliability
- Patented Super Barrier Rectifier Technology
- High Forward Surge Current Capability
- High Temperature Soldering
- Ultra Power Loss, High Efficiency

APPLICATION

- For surface mounted applications

RFQ

[Request For Quotation](#)

PART CODE GUIDE

TO277	SB10	S	100L
1	2	3	4

- 1) **TO277**: SMD Schottky Barrier Rectifier, Package TO-277 series
- 2) **SB10**: Specification code for original part number SB10 type, Forward Current 10A Max.
- 3) **S**: Package code, Tape/Reel, 5000pcs/reel.
- 4) **100L**: Specification code for Reverse Voltage 100V Max.

SMD SCHOTTKY BARRIER RECTIFIER TO-277 SERIES

DIMENSION (Unit: Inch/mm)

Image for reference



Marking: SB10100L

TO-277

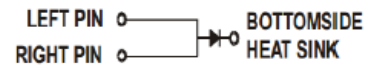
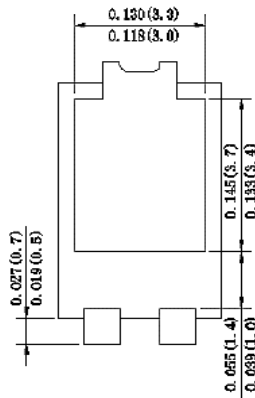
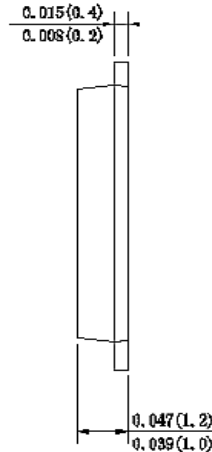
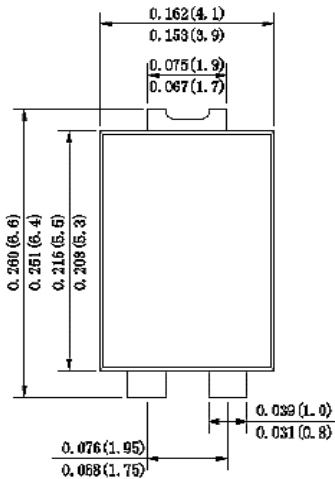

Recommend Pad Layout

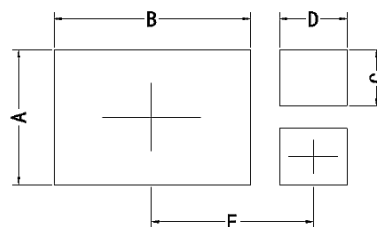

Symbol	Unit (inch)	Unit (mm)
A	0.142	3.60
B	0.211	5.35
C	0.059	1.50
D	0.073	1.85
E	0.169	4.30

SMD SCHOTTKY BARRIER RECTIFIER TO-277 SERIES
MECHANICAL DATA

Case	Terminals	Polarity	Mounting Position	Weight per piece
JEDEC TO-277 molded plastic body	Plated Leads Solderable per MIL-STD-202 Method 208	Polarity symbol marking on case	Any	0.003 Ounce, 0.092 grams

MAX. RATING & CHARACTERISTICS

Parameter	SYMBOLS	VALUE			UNITS
		Min.	Typical	Max.	
Repetitive Peak Reverse Voltage	V _{RRM}			100	Volts
RMS Voltage	V _{RMS}			70	Volts
DC Blocking Voltage	V _{DC}			100	Volts
Average Rectified Output Current	I _(O)			10	A
Non- Repetitive Peak Forward Surge Current 8.3ms Single Half Sine-wave Superimposed On Rated Load (JEDEC Method)	I _{FSM}		150		A
Forward Voltage Drop At 10A	V _F			0.85	Volts
Peak Reverse Current At Rated DC Blocking Voltage	I _R			0.3	mA
				15	mA
Thermal Resistance	R _{QJA}		80		°C/W
Junction To Ambient	R _{QJL}		15		°C/W
Operating Junction Temperature Range	T _J	-55		+150	°C
Storage Temperature Range	T _{STG}	-55		+150	°C

Note

1. Ratings at 25 C ambient temperature unless otherwise specified. Single phase half-wave 60Hz, resistive or inductive load, for capacitive load current derate by 20%.
2. Valid provided that are kept at ambient temperature at a distance of 9.5mm from the case
3. Fr-4pcs. 2 oz. copper, Min. recommend pad layout. 18.8*14.4mm, Anode pad dimensions 5.6*14.4mm.

SMD SCHOTTKY BARRIER RECTIFIER TO-277 SERIES
RELIABILITY

Number	Experiment Items	Experiment Method And Conditions	Reference Documents
1	Solder Resistance Test	Test 250°C± 5°C for 10 ± 2 sec. Immerse body into solder 1/16" ± 1/32"	MIL-STD-750D METHOD-2031.2
2	Solderability Test	230°C ±5°C for 5 sec.	MIL-STD-750D METHOD-2026.1 0
3	Pull Test	1 kg in axial lead direction for 10 sec.	MIL-STD-750D METHOD-2036.4
4	Bend Test	0.5Kg Weight Applied To Each Lead, Bending Arcs 90 °C ± 5 °C For 3 Times	MIL-STD-750D METHOD-2036.4
5	High Temperature Reverse Bias Test	TA=100°C for 1000 Hours at VR=80% Rated VR	MIL-STD-750D METHOD-1038.4
6	Forward Operation Life Test	TA=25°C Rated Average Rectified Current	MIL-STD-750D METHOD-1027.3
7	Intermittent Operation Life Test	On state: 5 min with rated IRMS Power Off state: 5 min with Cool Forced Air. On and off for 1000 cycles.	MIL-STD-750D METHOD-1036.3
8	Pressure Cooker Test	15 PSIG, TA=121°C, 4 hours	MIL-S-19500 APPENOIXC
9	Temperature Cycling Test	-55°C~+125°C; 30 Minutes For Dwelled Time 5 minutes for transferred time. Total: 10 cycles.	MIL-STD-750D METHOD-1051.7
10	Thermal Shock Test	0°C for 5 minutes., 100°C for 5minutes, Total: 10 cycles	MIL-STD-750D METHOD-1056.7
11	Forward Surge Test	8.3ms Single Sale Sine-wave One Surge.	MIL-STD-750D METHOD-4066.4
12	Humidity Test	TA=65°C, RH=98% for 1000 hours.	MIL-STD-750D METHOD-1021.3
13	High Temperature Storage life Test	150°C for 1000 Hours	MIL-STD-750D METHOD-1031.5

SMD SCHOTTKY BARRIER RECTIFIER TO-277 SERIES

SUGGESTED REFLOW PROFILE (For Reference Only)

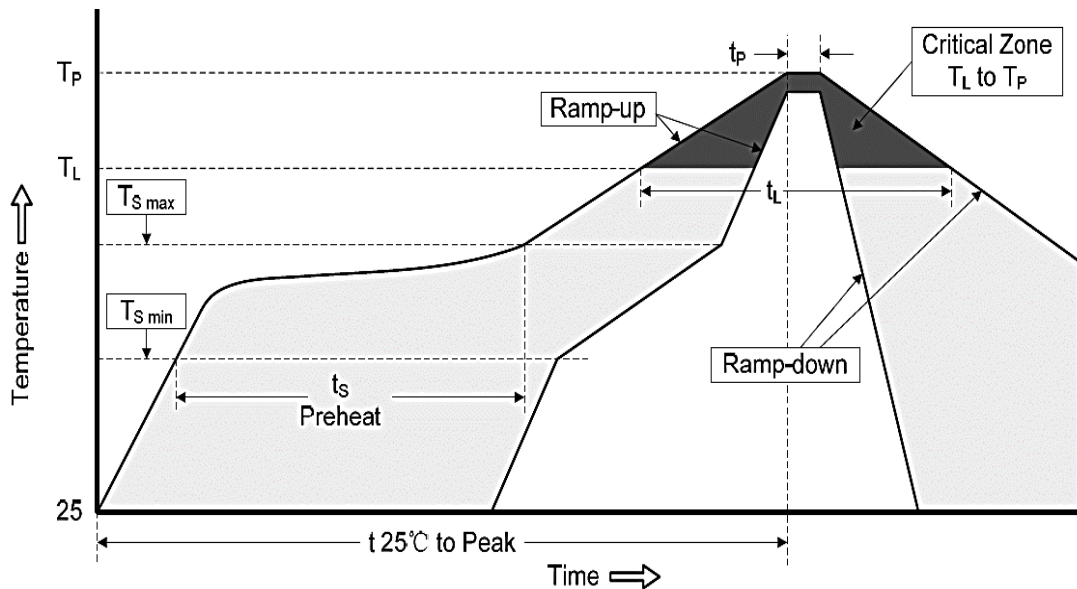

Profile Feature		Pb-Free Assembly
Average Ramp-up Rate (Ts Max to Tp)		3°C/second Max
Preheat	Temperature Min (Ts Min.)	150°C
	Temperature Max (Ts Max.)	200°C
	Time (ts Min. to ts Max.)	60 ~ 180 seconds
Time maintained above	Temperature (Tl)	217°C
	Time (tl)	60 ~ 150 seconds
Peak/Classification Temperature (Tp)		260 °C
Time within 5°C of actual Peak Temperature (tp)		10 seconds
Ramp-down rate		6 °C /Second Max.
Time 25 °C to Peak Temperature		6 minutes Max.
Suggest reflow times		3 Times Max.

SMD SCHOTTKY BARRIER RECTIFIER TO-277 SERIES

RATINGS AND CHARACTERISTIC CURVES (For Reference Only)

Fig.1 - Forward Current Derating Curve

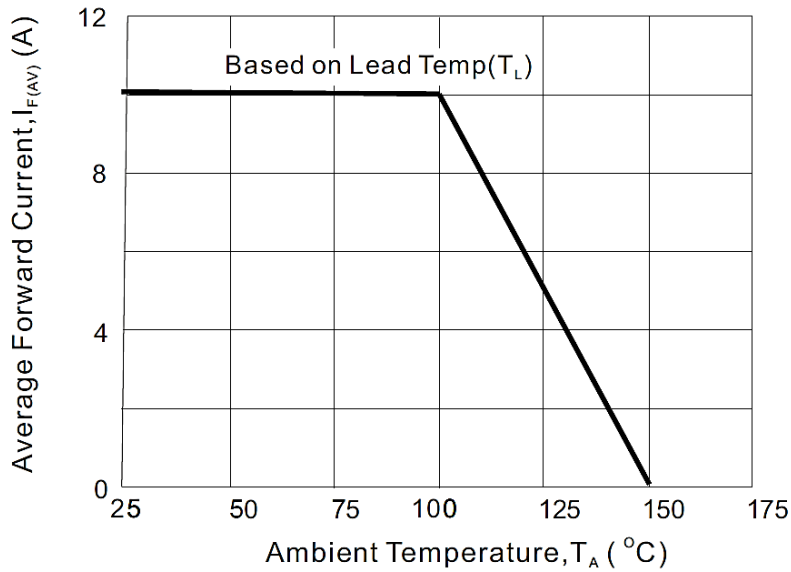
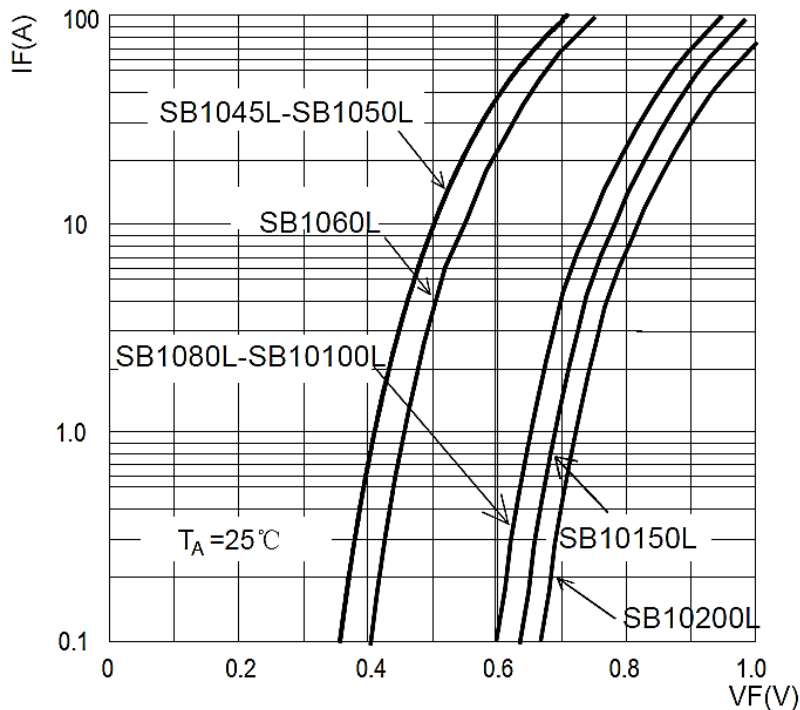

Fig2 : Instantaneous Forward Voltage



SMD SCHOTTKY BARRIER RECTIFIER TO-277 SERIES

RATINGS AND CHARACTERISTIC CURVES (For Reference Only)

Fig3: Surge Forward Current Capability

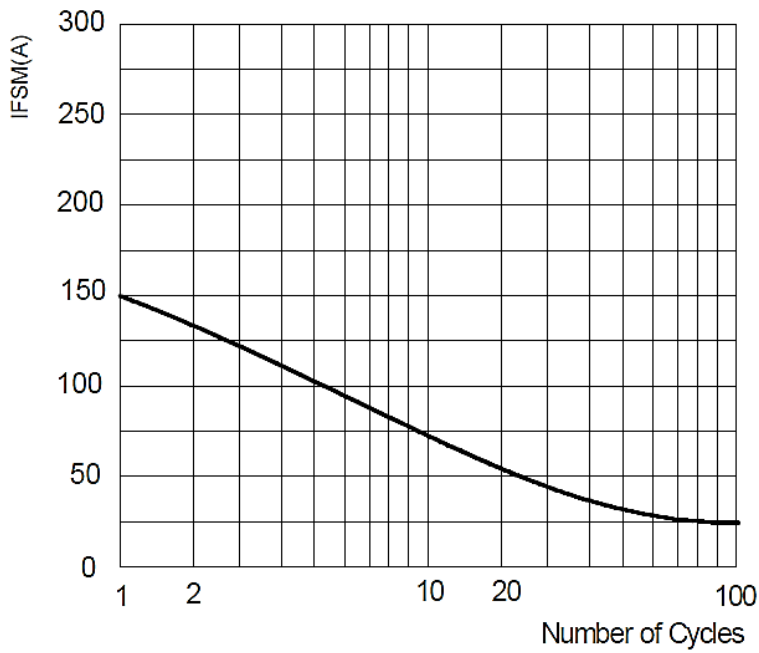
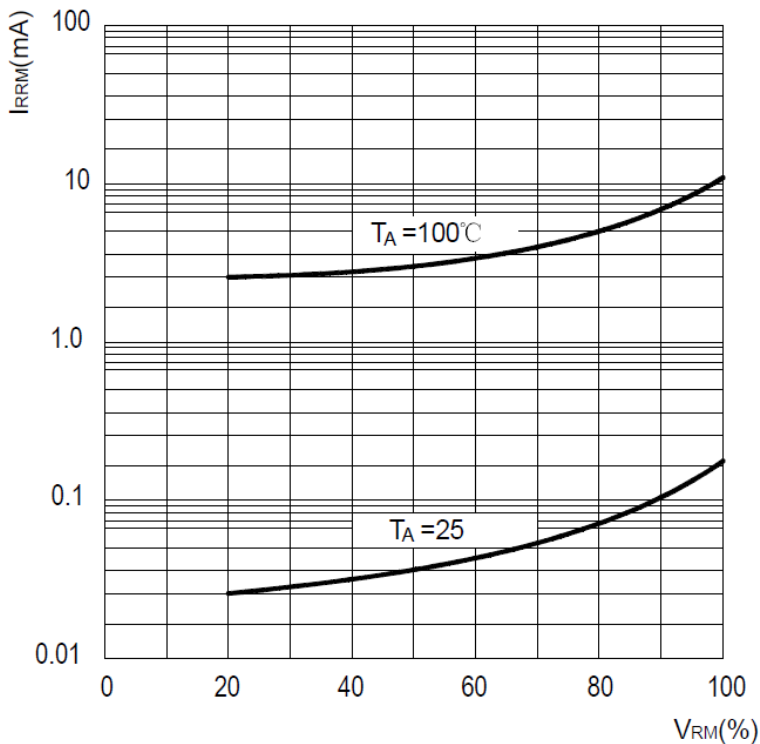

Fig4: Typical Reverse Characteristics



SMD SCHOTTKY BARRIER RECTIFIER TO-277 SERIES

TAPE/REEL (Unit: mm)

All Devices are packed in accordance with EIA standard RS-481-A and specifications.

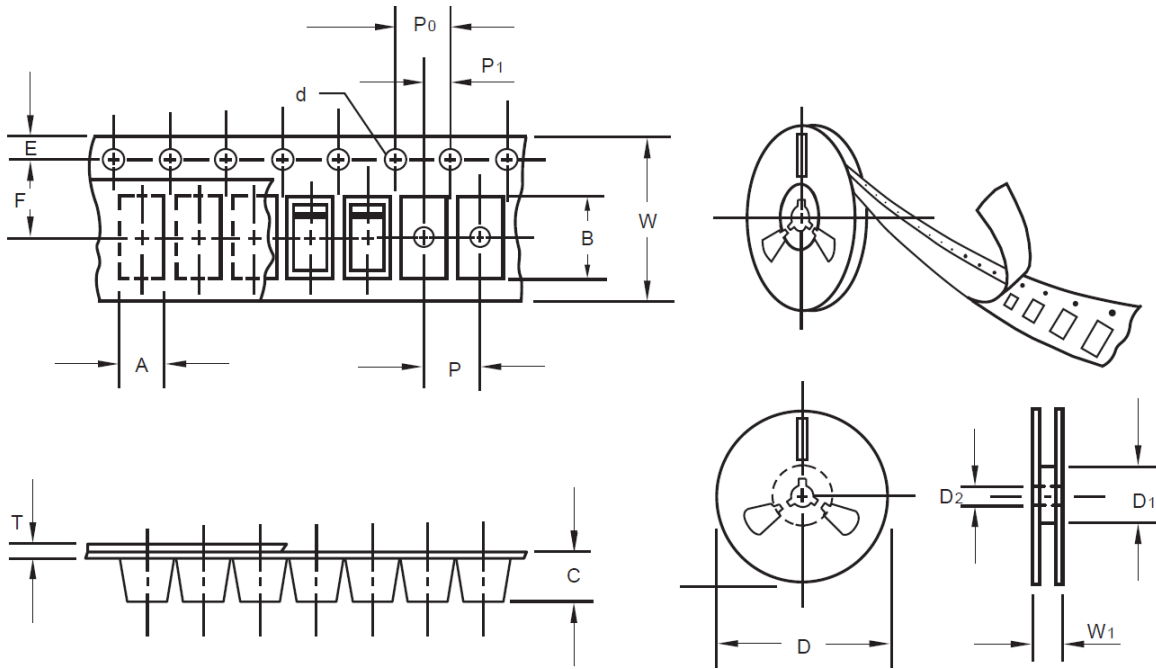

Item	Symbol	Tolerance	TO-277
Carrier width	A	0.1	4.45
Carrier Length	B	0.1	7.0
Carrier Depth	C	0.1	1.60
Sprocket hole	d	0.05	1.55
13" Reel outside diameter	D	2.0	330.00
13" Reel inner diameter	D1	Min.	50.00
7" Reel outside diameter	-	-	-
7" Reel inner diameter	-	-	-
Feed hole diameter	D2	0.5	13.00
Sprocket hole position	E	0.1	1.75
Punch hole position	F	0.1	7.50
Punch hole pitch	P	0.1	8.00
Sprocket hole pitch	P0	0.1	4.00
Embossment center	P1	0.1	2.00
Overall tape thickness	T	0.1	0.25
Tape width	W	0.3	12.00
Reel width	W1	1.0	12.30

SMD SCHOTTKY BARRIER RECTIFIER TO-277 SERIES

PACKAGE For Reference

Case Code	TO-277
Reel Size	13"
Reel Size	330 mm
MPQ/Reel	5000 pcs
Qty. /Box	10000 pcs
G.W/Box	6 lbs

DISCLAIMER

NextGen Component, Inc. reserves the right to make changes to the product(s) and or information contained herein without notice. No liability is assumed as a result of their use or application. No rights under any patent accompany the sale of any such product(s) or information