

## High-performance Video Driver Series



# Standard 3-output Video Driver

**BA7622F, BA7623F**

No.09065EAT04

**•Description**

The BA7622F and BA7623F are video driver ICs with three built-in circuits, developed for video equipment. The three circuits in the BA7622F, two sync-tip clamp inputs and one bias input, are terminated by internal resistances of 20 k $\Omega$ . The BA7623F output pins can be connected directly in a DC coupling mode. Each output can drive 2 lines of load (75 $\Omega$ x2). Suitable to connect to a 2Vpp output type signal processing LSI and DAC.

**•Features**

Common

- 1) 2 lines can be driven from each output
- 2) Can be operated by Vcc=4.5 V

BA7622F

- 1) Large output dynamic range (3.3 Vpp, Vcc=5 V)
- 2) Built-in, 2 clamp input circuits and 1 bias input circuit
- 3) Y signal, C signal, and composite video signal can be driven simultaneously by this particular IC.

BA7623F

- 1) Wide output dynamic range (3.3 Vpp, Vcc=5 V)
- 2) Can be directly connected to previous stage circuit

**•Applications**

TV, VCR, camcorder, and other video equipment.

**•Product lineup**

Parameter	BA7622F	BA7623F
Input pin configuration	2 clamp input circuits 1 bias input circuit	Previous stage direct connection (Base direct input)

**•Absolute maximum ratings** (Ta=25°C)

Parameter	Symbol	Limits	Unit
Supply voltage	V <sub>Max</sub>	8.0	V
Power dissipation	Pd	550 *1	mW
Operating temperature	Topr	-25~+75	°C
Storage temperature	Tstg	-55~+125	°C

25°C

\*1 Reduce by 5.5 mW/°C over

●Operating range (Ta=25°C)

Parameter	Symbol	Limits	Unit
Supply Voltage	VCC	4.5~5.5	V

Note: This IC is not designed to be radiation-resistant.

●Electrical characteristics (Unless otherwise specified, Ta=25°C, Vcc=5 V and 2 lines are driven.)

BA7622F

Parameter	Symbol	Min.	Typ.	Max	Unit	Conditions
Circuit Current	I <sub>cc</sub>	-	23.6	35.4	mA	No signal
Maximum output level	V <sub>om</sub>	2.8	3.3	-	Vp-p	f=1kHz, THD=1.0%
Voltage gain	G <sub>v</sub>	-1.2	-0.6	0	dB	f=1kHz, V <sub>IN</sub> =2.0Vp-p
Frequency characteristic	G <sub>f</sub>	-3	0	1.3	dB	10kHz/1MHz, V <sub>IN</sub> =1.0Vp-p
Differential gain 75Ω drive1	DG1	-	0.4	1.0	%	V <sub>IN</sub> =2.0Vp-p, Standard staircase signal
Differential phase 75Ω drive1	DP1	-	0.4	1.0	deg	V <sub>IN</sub> =2.0Vp-p, Standard staircase signal
Differential gain 75Ω drive2	DG2	-	0.7	2.0	%	V <sub>IN</sub> =2.0Vp-p, Standard staircase signal
Differential phase 75Ω drive2	DP2	-	0.7	2.0	deg	V <sub>IN</sub> =2.0Vp-p, Standard staircase signal
Interchannel crosstalk	C <sub>T</sub>	-	-60	-	dB	f=4.43MHz, V <sub>IN</sub> =2.0Vp-p
Input impedance(V <sub>IN3</sub> )	Z <sub>IN3</sub>	17	20	23	kΩ	—
Total harmonic distortion(V <sub>IN3</sub> )	T <sub>HD32</sub>	-	0.1	0.5	%	f=1kHz, V <sub>IN</sub> =1.0Vp-p

BA7623F

Parameter	Symbol	Min.	Typ.	Max	Unit	Conditions
Circuit Current	I <sub>cc</sub>	-	25.2	37.8	mA	No signal
Maximum output level	V <sub>om</sub>	2.9	3.4	-	Vp-p	f=1kHz, THD=1.0%
Voltage gain	G <sub>v</sub>	-1.0	-0.5	0	dB	f=1kHz, V <sub>IN</sub> =2.0Vp-p
Frequency characteristics	G <sub>f</sub>	-3	0	1	dB	10kHz/1MHz, V <sub>IN</sub> =1.0Vp-p
Differential gain 75Ω drive1	DG1	-	0.4	1.0	%	V <sub>IN</sub> =2.0Vp-p, Standard staircase signal
Differential phase 75Ω drive1	DP1	-	0.4	1.0	deg	V <sub>IN</sub> =2.0Vp-p, Standard staircase signal
Differential gain 75Ω drive2	DG2	-	0.7	2.0	%	V <sub>IN</sub> =2.0Vp-p, Standard staircase signal
Differential phase 75Ω drive2	DP2	-	0.7	2.0	deg	V <sub>IN</sub> =2.0Vp-p, Standard staircase signal
Interchannel crosstalk	C <sub>T</sub>	-	-60	-	dB	f=4.43MHz, V <sub>IN</sub> =2.0Vp-p
Total harmonic distortion	THD	-	0.1	0.5	%	f=1kHz, V <sub>IN</sub> =1.0Vp-p

●Block diagram

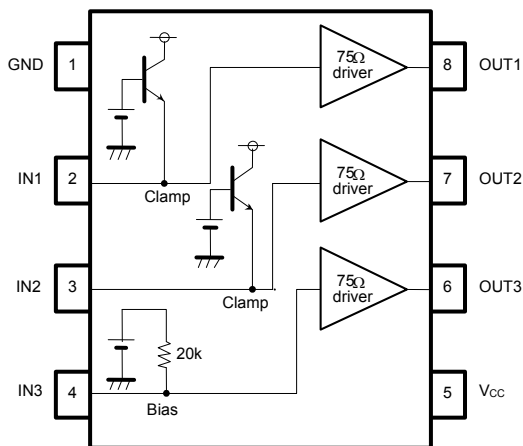

Fig.1 BA7622F

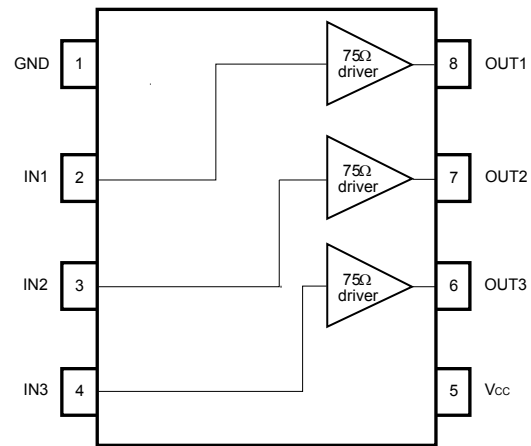

Fig.2 BA7623F

•Measurement circuit

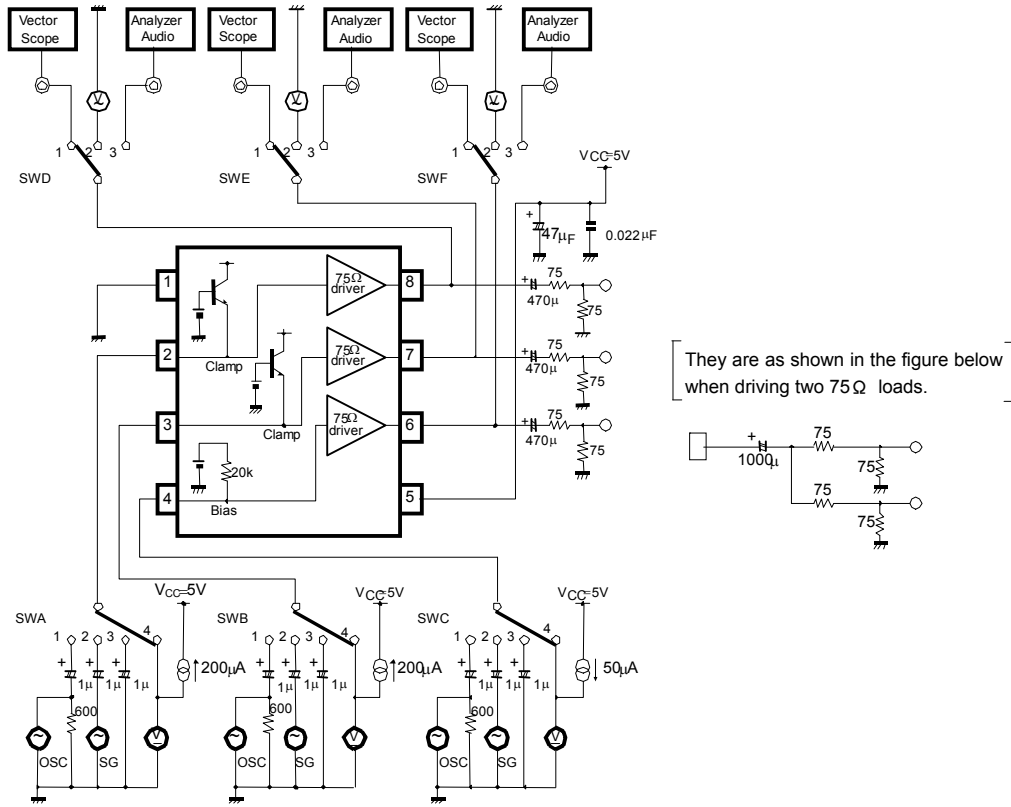

Fig.3 BA7622F

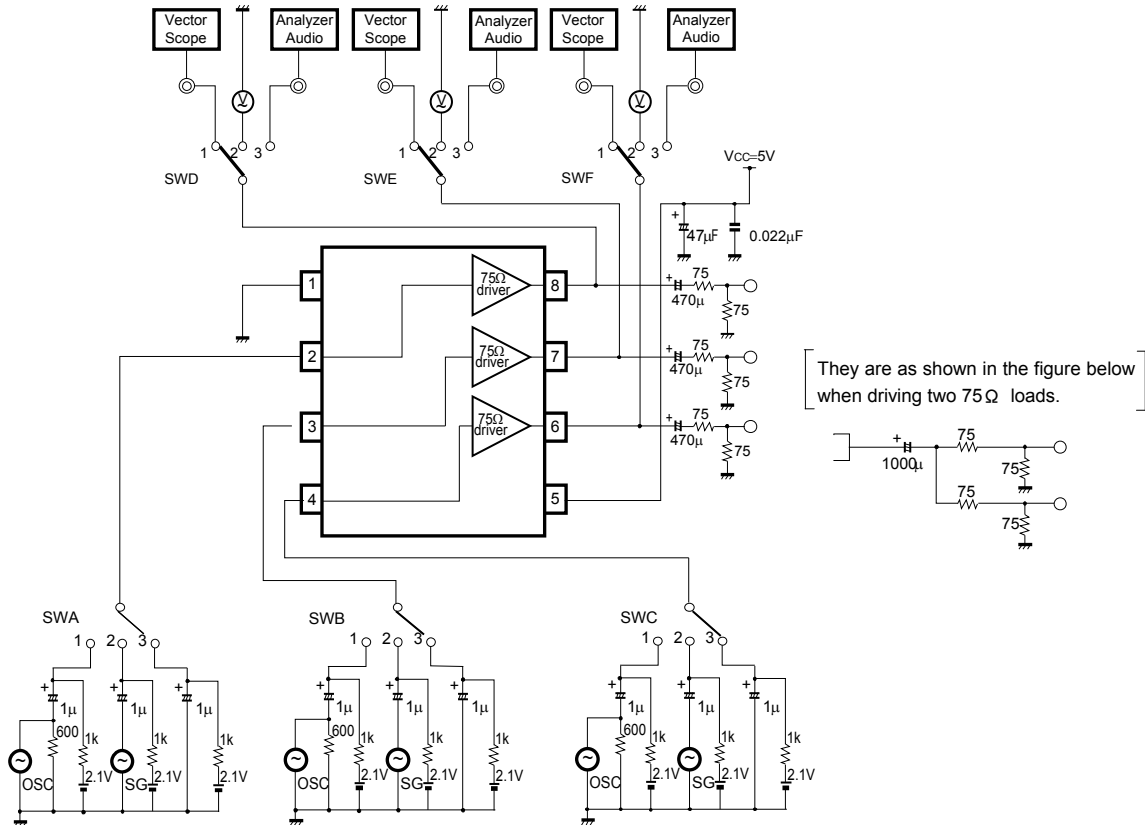

Fig.4 BA7623F

## ●Measurement methods and conditions (BA7622F)

Parameter	Symbol	IN1	IN2	IN3	OUT1	OUT2	OUT3	Conditions
		SWA	SWB	SWC	SWD	SWE	SWF	
Circuit current	I <sub>CC</sub>	3	3	3	×	×	×	-
Maximum output level	V <sub>OM12</sub>	1	3	3	3	×	×	* 1
	V <sub>OM22</sub>	3	1	3	×	3	×	
	V <sub>OM32</sub>	3	3	1	×	×	3	
Voltage gain	G <sub>V12</sub>	1	3	3	3	×	×	* 2
	G <sub>V22</sub>	3	1	3	×	3	×	
	G <sub>V32</sub>	3	3	1	×	×	3	
Frequency characteristic	f <sub>12</sub>	1	3	3	3	×	×	-
	f <sub>22</sub>	3	1	3	×	3	×	
	f <sub>32</sub>	3	3	1	×	×	3	
Interchannel crosstalk	C <sub>T112</sub>	1	3	3	×	3	×	-
	C <sub>T113</sub>	1	3	3	×	×	3	
	C <sub>T211</sub>	3	1	3	3	×	×	
	C <sub>T213</sub>	3	1	3	×	×	3	
	C <sub>T311</sub>	3	3	1	3	×	×	
Input impedance	Z <sub>IN3</sub>	3	3	4	×	×	×	* 3
	T <sub>HD12</sub>	1	3	3	3	×	×	* 4
Total harmonic distortion	T <sub>HD22</sub>	3	1	3	×	3	×	
	T <sub>HD32</sub>	3	3	1	×	×	3	

× : Switches 1, 2, and 3 can be

## \* 1 : Maximum output level

Connect a distortion meter to the output. Apply a f=1 kHz, 1 Vp-p sine wave to the input and adjust the input level so that the output distortion becomes 1.0%. The maximum output level V<sub>OM</sub> (Vp-p) is the output voltage at that time.

## \* 2 : Voltage gain

Apply a f=1MHz, 2.0 Vp-p sine wave to the input.. The voltage gain  $G_V=20\log[V_{OUT}/V_{IN}]$  (dB).

## \* 3 : Input resistance

Measure the input pin voltage V<sub>IN50</sub>, when 50 μA is injected at the input pin. Measure the open voltage V<sub>IN0</sub> of the input pin. The input resistance  $Z=(V_{IN50}-V_{IN0})/50\times 10^{-6}$  [Ω].

## \* 4 : Total harmonic distortion

Apply a f=1kHz, 1.0 Vp-p sine wave to the input and measure by connecting a distortion meter to the output.

## ●Measurement methods and conditions (BA7623F)

Parameter	Symbol	IN1	IN2	IN3	OUT1	OUT2	OUT3	Conditions
		SWA	SWB	SWC	SWD	SWE	SWF	
Circuit current	I <sub>CC</sub>	3	3	3	×	×	×	-
Maximum output level	V <sub>OM12</sub>	1	3	3	3	×	×	* 1
	V <sub>OM22</sub>	3	1	3	×	3	×	
	V <sub>OM32</sub>	3	3	1	×	×	3	
Voltage gain	G <sub>V12</sub>	1	3	3	3	×	×	* 2
	G <sub>V22</sub>	3	1	3	×	3	×	
	G <sub>V32</sub>	3	3	1	×	×	3	
Frequency characteristic	f <sub>12</sub>	1	3	3	3	×	×	-
	f <sub>22</sub>	3	1	3	×	3	×	
	f <sub>32</sub>	3	3	1	×	×	3	
Interchannel crosstalk	C <sub>T112</sub>	1	3	3	×	3	×	-
	C <sub>T113</sub>	1	3	3	×	×	3	
	C <sub>T211</sub>	3	1	3	3	×	×	
	C <sub>T213</sub>	3	1	3	×	×	3	
	C <sub>T311</sub>	3	3	1	3	×	×	
Total harmonic distortion	T <sub>HD12</sub>	1	3	3	3	×	×	* 3
	T <sub>HD22</sub>	3	1	3	×	3	×	
	T <sub>HD32</sub>	3	3	1	×	×	3	
Differential gain (DG)	DG1	2	3	3	1	×	×	-
	DG2	3	2	3	×	1	×	
	DG3	3	3	2	×	×	1	
Differential phase (DP)	DP1	2	3	3	1	×	×	-
	DP2	3	2	3	×	1	×	
	DP3	3	3	2	×	×	1	

× : Switches 1, 2, and 3 can be

## \* 1 : Maximum output level

Connect a distortion meter to the output. Apply a f=1 kHz, 1 Vp-p sine wave to the input and adjust the input level so that the output distortion becomes 1.0%. The maximum output level V<sub>OM</sub> (Vp-p) is the output voltage at that time.

## \* 2 : Voltage gain

Apply a f=1MHz, 2.0 Vp-p sine wave to the input. The voltage gain is calculated as follows:  $G_V=20\log[V_{OUT}/V_{IN}]$  (dB)

## \* 3 : Total harmonic distortion

Apply a f=1kHz, 1.0 Vp-p sine wave to the input and measure by connecting a distortion meter to the output.

●Application circuit

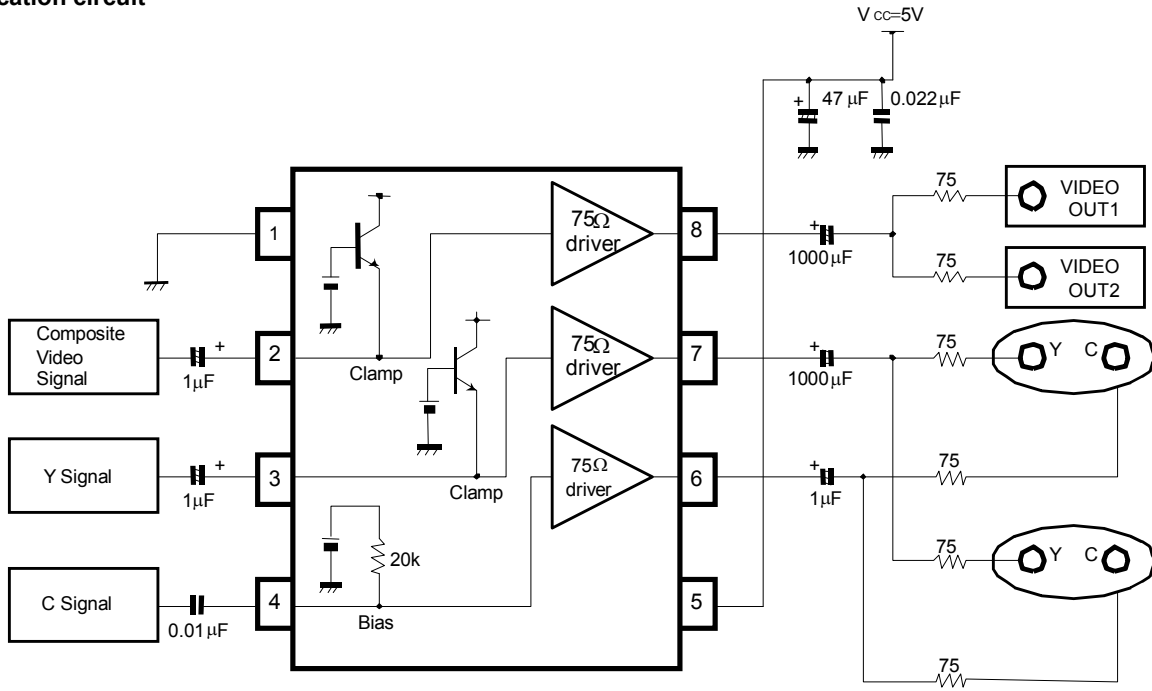

Example of input VIDEO , Y , and C signals.

Fig.5 BA7622F

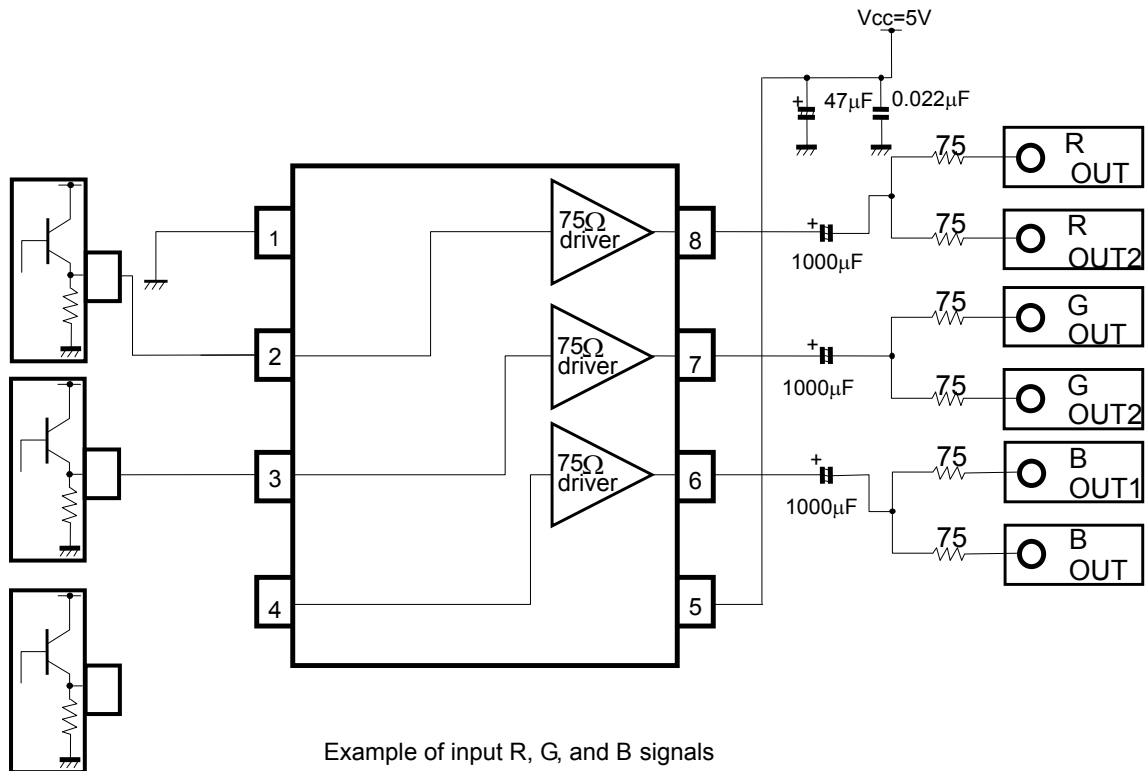

Example of input R, G, and B signals

Fig.6 BA7623F

•Pin descriptions (1/2)

BA7622F

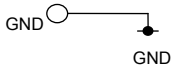
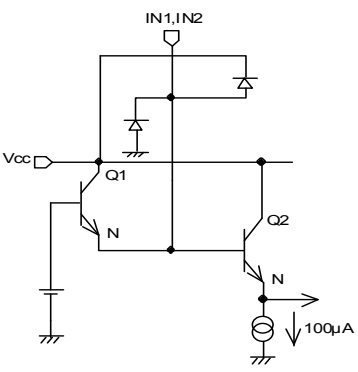
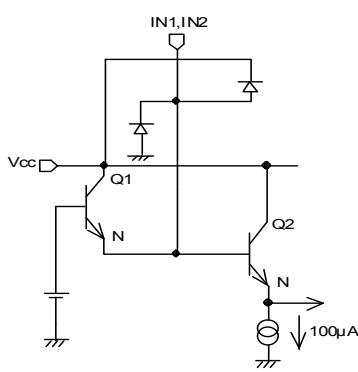
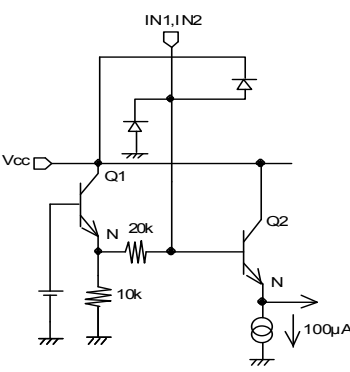
Pin No.	Pin name	IN	OUT	Typical voltage	Equivalent Circuit	Function
1	GND	○	—	0V		GND terminal
2	IN1	○	—	1.4V		Clamp input pin Inputs a video signal or Y/C separated Y signal.
3	IN2	○	—	1.4V		Clamp input pin Inputs a video signal or Y/C separated Y signal.
4	IN3	○	—	2.7V		Bias input pin Inputs a chroma signal.

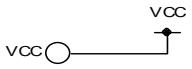
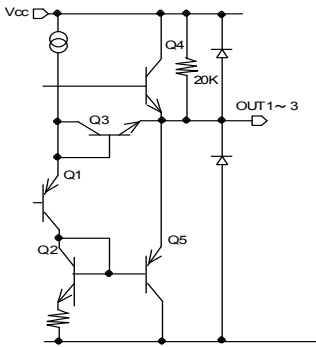
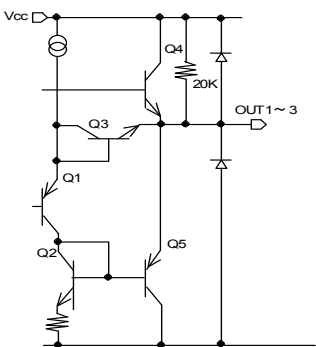
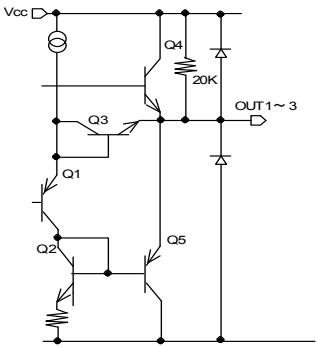
Pin No.	Pin name	IN	OUT	Typical voltage	Equivalent Circuit	Function
5	VCC	○	—	5.0V		Vcc terminal
6	OUT3	—	○	2.0V		Video driver output (Bias input)  Outputs a chroma signal.  When output is forced to ground, the protection circuit activates power save mode.
7	OUT2	—	○	0.6V		Video driver output pin (Clamp input)  Outputs a video signal or Y/C separated Y signal  When output is forced to ground, the protection circuit activates power save mode.
8	OUT1	—	○	0.6V		Video driver output pin (Clamp input)  Outputs a video signal or Y/C separated Y signal  When output is forced to ground, the protection circuit activates power save mode.

•Pin descriptions (2/2)

BA7623F

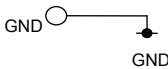
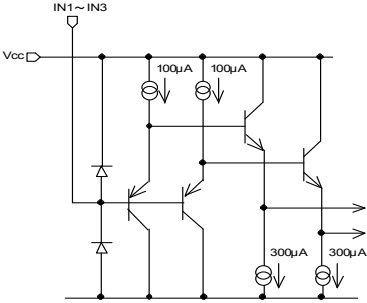
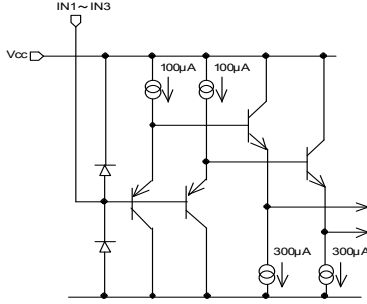
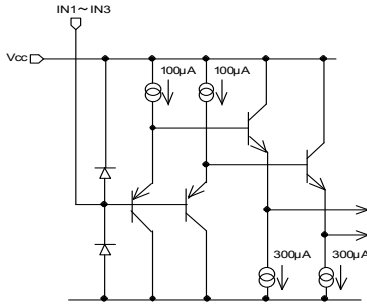
Pin No.	Pin name	IN	OUT	Typical voltage	Equivalent Circuit	Function
1	GND	○	—	0V		GND terminal
2	IN1	○	—	* 1		Base direct connect input  Set the input signal as composite video signal, chroma signal, or RGB signal. Input signal range 0.5~3.8 V.
3	IN2	○	—	* 1		Base direct connect input pin  Set the input signal as composite video signal, chroma signal, or RGB signal. Input signal range 0.5~3.8 V.
4	IN3	○	—	* 1		Base direct connect input pin  Set the input signal as composite video signal, chroma signal, or RGB signal. Input signal range 0.5~3.8 V.

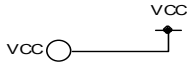
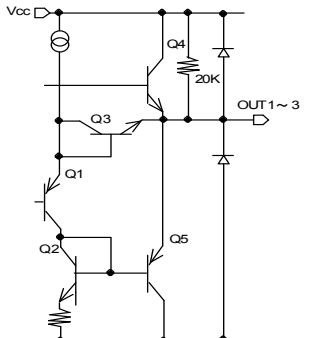
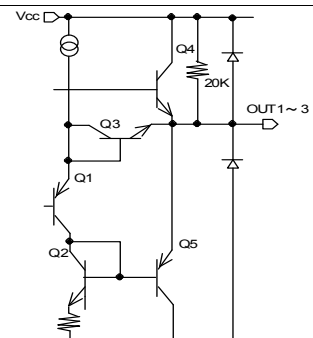
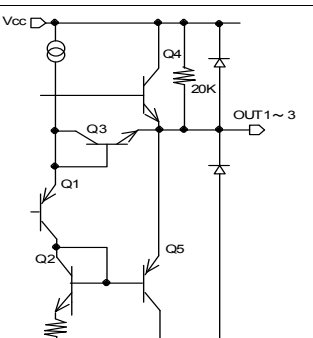

Pin No.	Pin name	IN	OUT	Typical voltage	Equivalent Circuit	Function
5	VCC	○	—	5.0V		Vcc terminal
6	OUT3	—	○	* 2		Video driver output (Base direct connect input)  * 2 Output potential and * 1 input potential have the same signal level.  When output is forced to ground, the protection circuit activates power save mode.
7	OUT2	—	○	* 2		Video driver output (Base direct connect input)  * 2 Output potential and * 1 input potential have the same signal level.  When output is forced to ground, the protection circuit activates power save mode.
8	OUT1	—	○	* 2		Video driver output (Base direct connect input)  * 2 Output potential and * 1 input potential have the same signal level.  When grounded to ground, the protection circuit operates to move to power save mode.

**●Operation Notes**

1. Numbers and data in entries are representative design values and are not guaranteed values of the items.
2. Although ROHM is confident that the example application circuit reflects the best possible recommendations, be sure to verify circuit characteristics for your particular application. Modification of constants for other externally connected circuits may cause variations in both static and transient characteristics for external components as well as this Rohm IC. Allow for sufficient margins when determining circuit constants.
3. Absolute maximum ratings  
Use of the IC in excess of absolute maximum ratings, such as the applied voltage or operating temperature range (Topr), may result in IC damage. Assumptions should not be made regarding the state of the IC (short mode or open mode) when such damage is suffered. A physical safety measure, such as a fuse, should be implemented when using the IC at times where the absolute maximum ratings may be exceeded.
4. GND potential  
Ensure a minimum GND pin potential in all operating conditions. Make sure that no pins are at a voltage below the GND at any time, regardless of whether it is a transient signal or not.
5. Thermal design  
Perform thermal design, in which there are adequate margins, by taking into account the permissible dissipation (Pd) in actual states of use.
6. Short circuit between terminals and erroneous mounting  
Pay attention to the assembly direction of the ICs. Wrong mounting direction or shorts between terminals, GND, or other components on the circuits, can damage the IC.
7. Operation in strong electromagnetic field  
Using the ICs in a strong electromagnetic field can cause operation malfunction.

●Reference data (1/5)

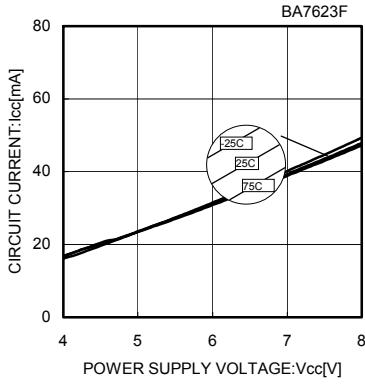

Fig.7 Circuit current vs. Supply voltage

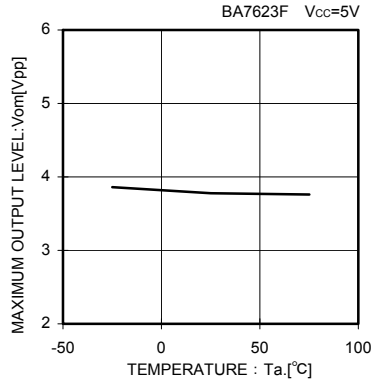

Fig.8 Maximum output level vs. Temperature

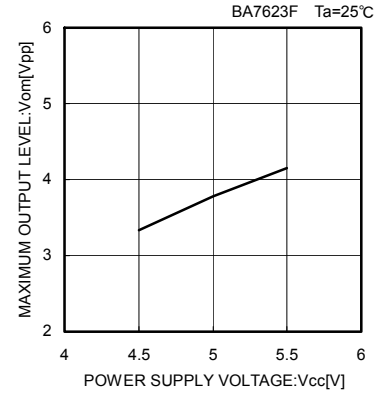

Fig.9 Maximum output level vs. Supply voltage

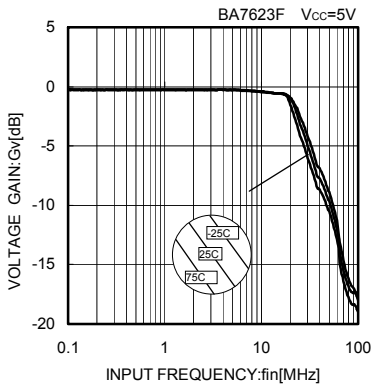

Fig.10 Frequency characteristic vs. Temperature

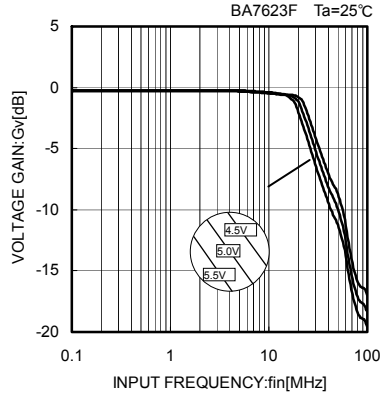

Fig.11 Frequency characteristic vs. Supply voltage

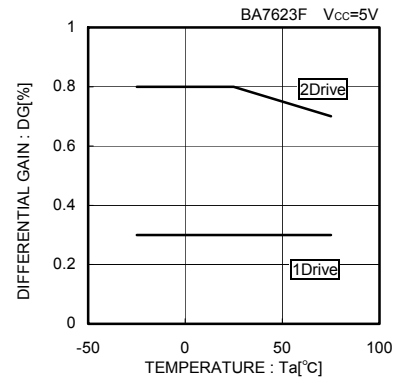

Fig.12 Differential gain vs. Temperature

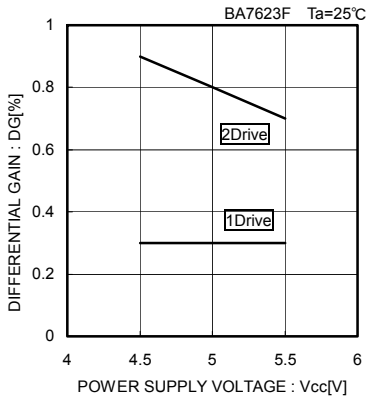

Fig.13 Differential gain vs. Supply voltage

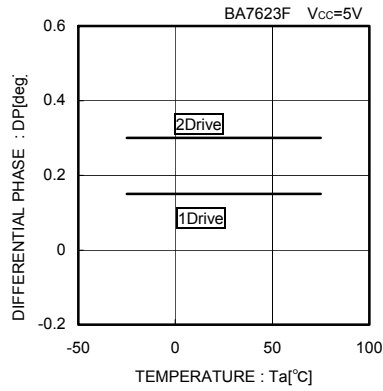

Fig.14 Differential phase vs. Temperature

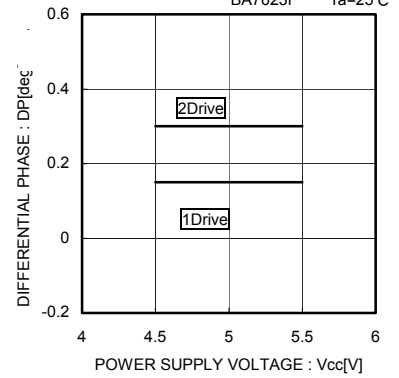

Fig.15 Differential phase vs. Supply voltage

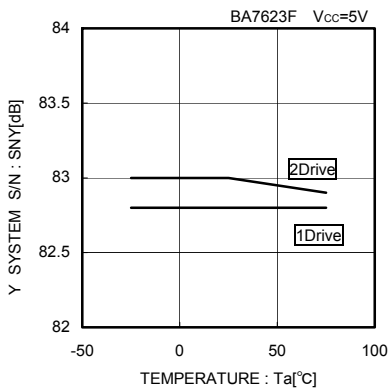

Fig.16 Y system S/N vs. Temperature

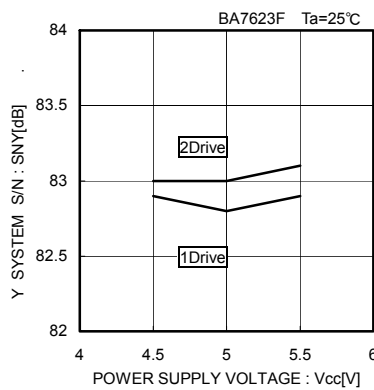

Fig.17 Y system S/N vs. Supply voltage

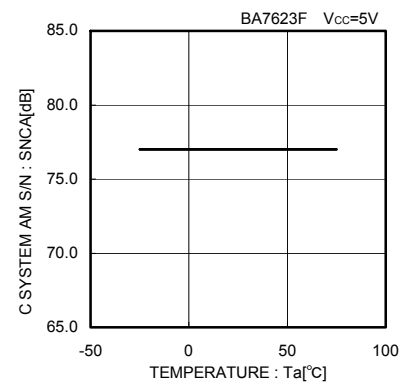

Fig.18 C system AM S/N vs. Temperature

●Reference data (2/5)

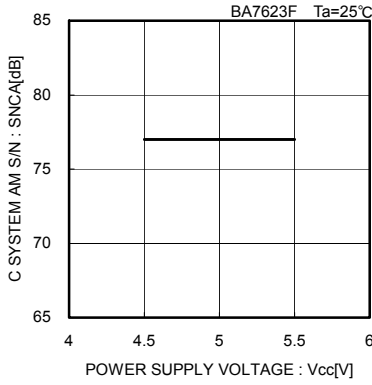

Fig.19 C system AM S/N vs. Supply voltage

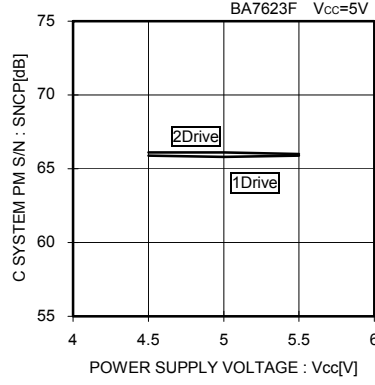

Fig.20 C system PM S/N vs. Supply voltage

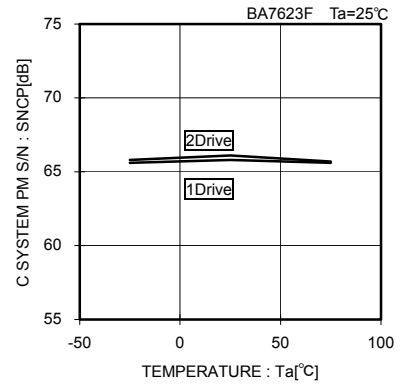

Fig.21 C system PM S/N vs. Temperature

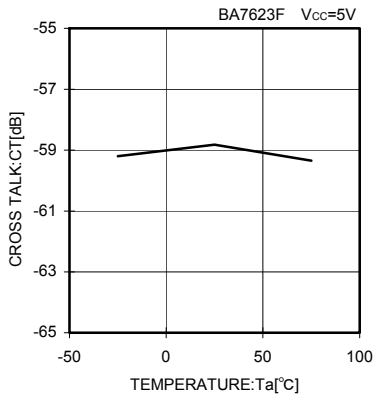

Fig.22 Cross talk vs. Temperature

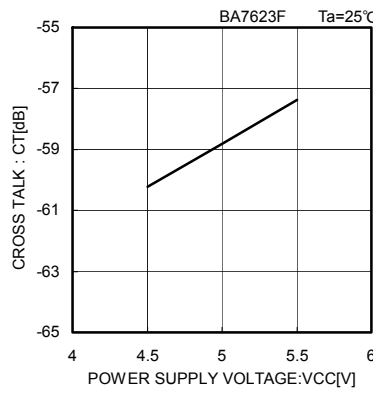

Fig.23 Cross talk vs. Supply voltage

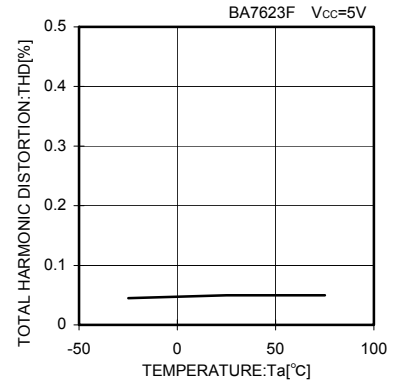

Fig.24 Total harmonic distortion vs. Temperature

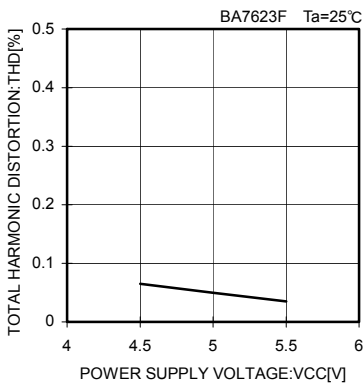

Fig.25 Total harmonic distortion vs. Supply voltage

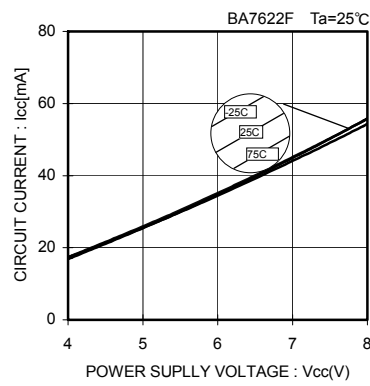

Fig.26 Circuit current vs. Supply voltage

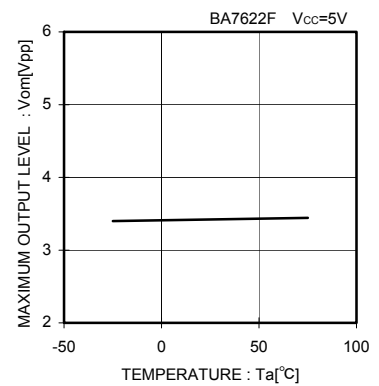

Fig.27 Maximum output level vs. Temperature

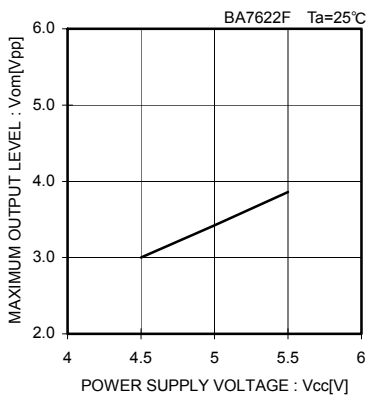

Fig.28 Maximum output level (clamp) vs. Supply voltage

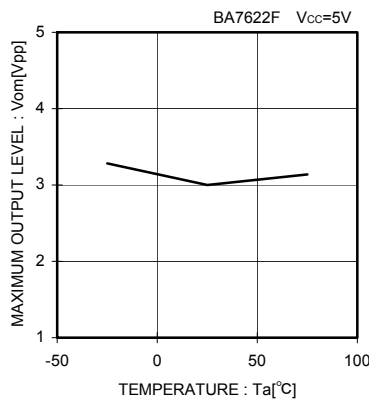

Fig.29 Maximum output level (bias) vs. Temperature

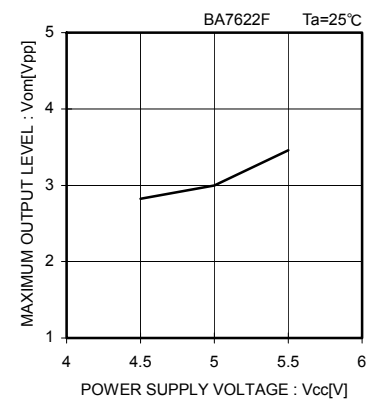

Fig.30 Maximum output level (bias) vs. Supply voltage

●Reference data (3/5)

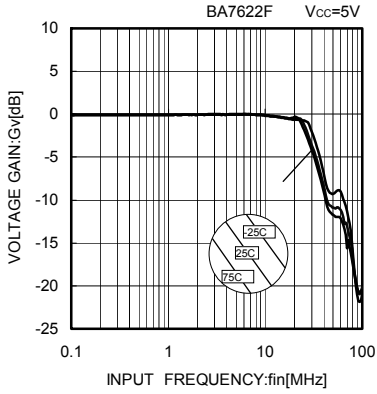

Fig.31 Frequency characteristic (clamp) vs. Temperature

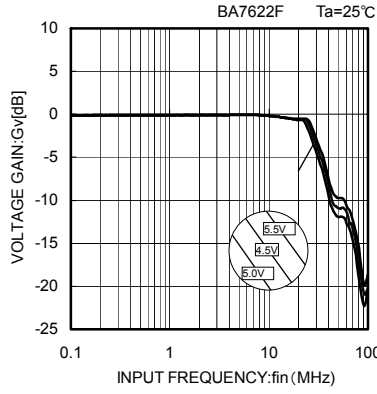

Fig.32 Frequency characteristic (clamp) vs. Supply voltage

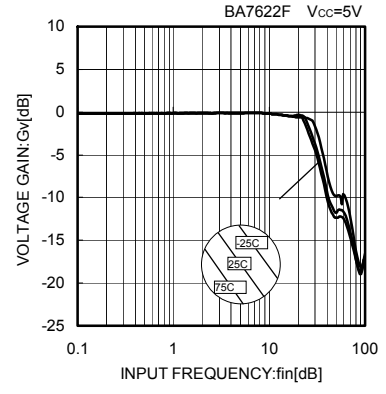

Fig.33 Frequency characteristic (bias) vs. Temperature

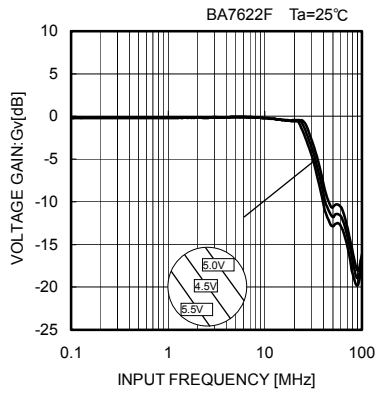

Fig.34 Frequency characteristic (bias) vs. Supply voltage

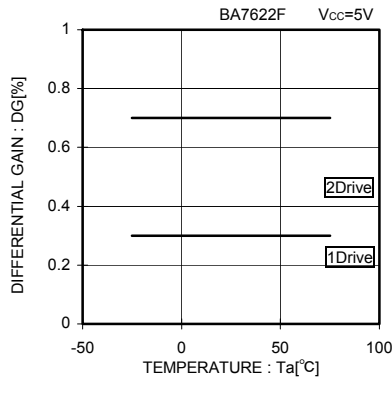

Fig.35 Differential gain (clamp) vs. Temperature

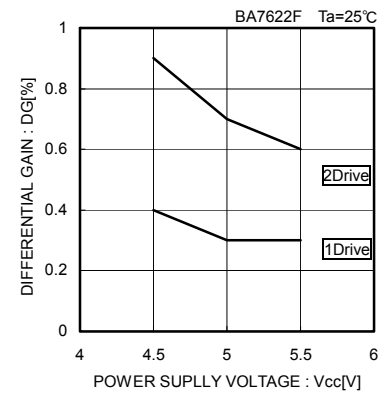

Fig.36 Differential gain (clamp) vs. Supply voltage

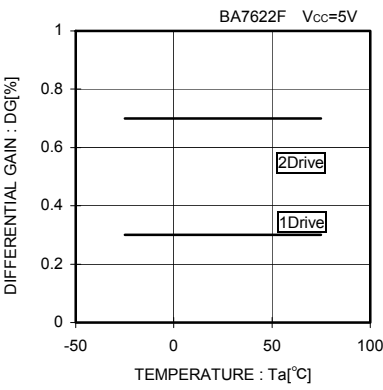

Fig.37 Differential gain (bias) vs. Temperature

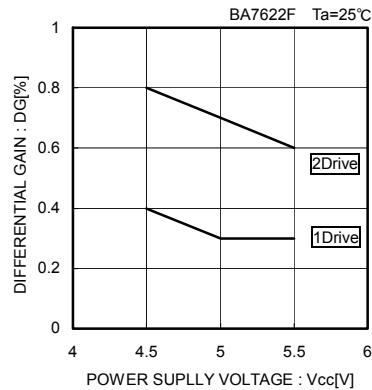

Fig.38 Differential gain (bias) vs. Supply voltage

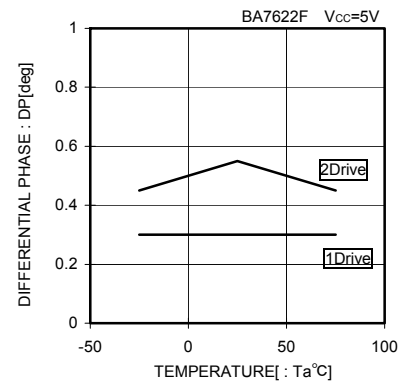

Fig.39 Differential phase (clamp) vs. Temperature

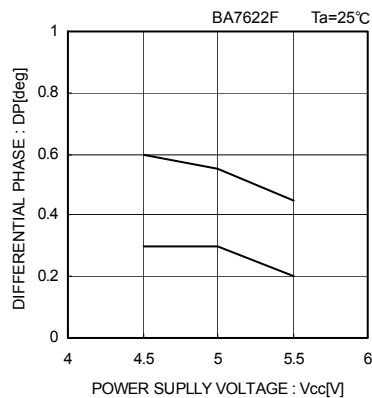

Fig.40 Differential phase (clamp) vs. Supply voltage

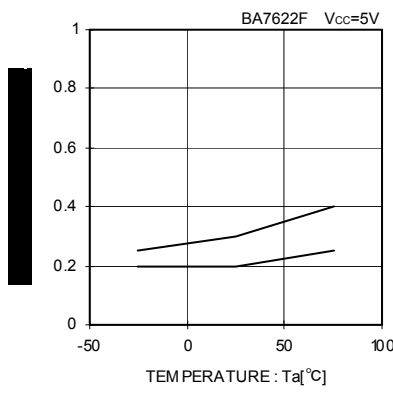

Fig.41 Differential phase (bias) vs. Temperature

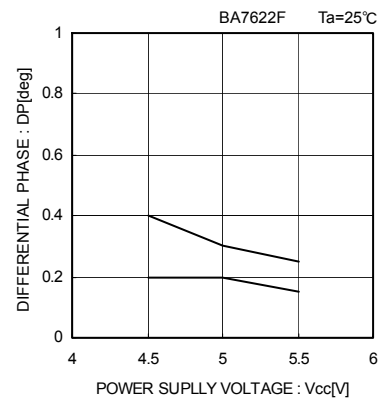

Fig.42 Differential phase (bias) vs. Supply voltage

●Reference data (4/5)

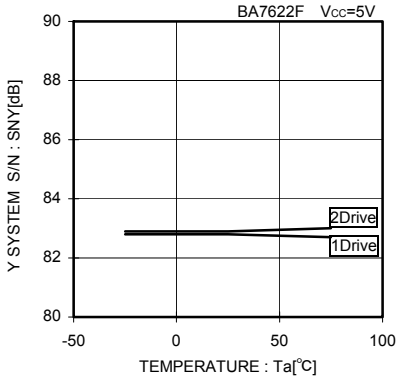

Fig.43 Y system S/N (clamp) vs. Temperature

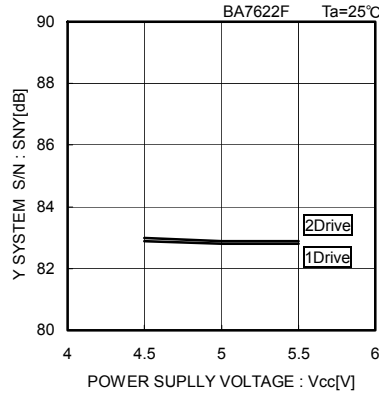

Fig.44 Y system S/N (clamp) vs. Supply voltage

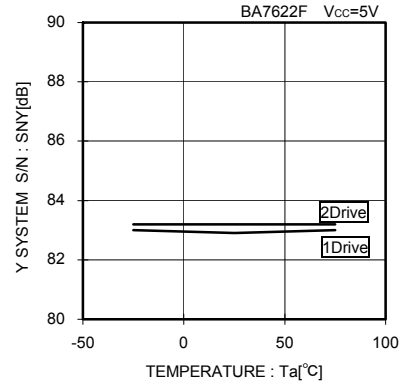

Fig.45 Y system S/N (bias) vs. Temperature

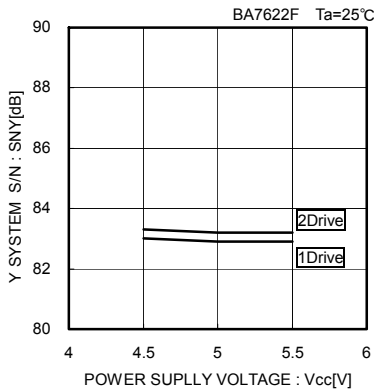

Fig.46 Y system S/N (bias) vs. Supply voltage

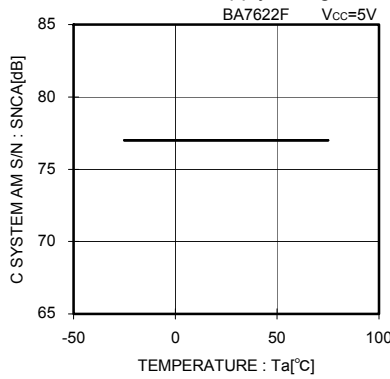

Fig.47 C system AM S/N (clamp) vs. Temperature

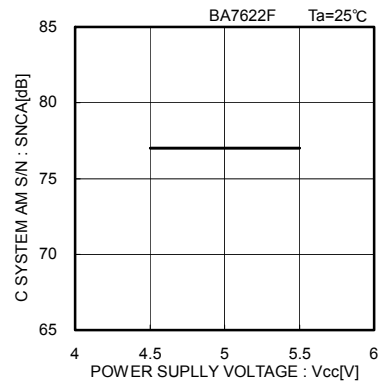

Fig.48 C system AM S/N (clamp) vs. Supply voltage

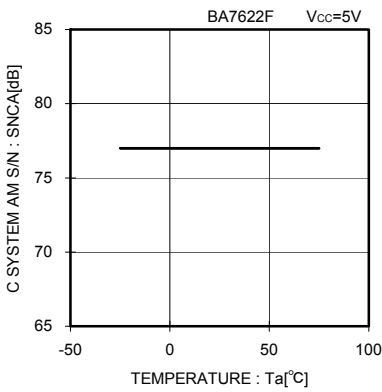

Fig.49 C system AM S/N (bias) vs. Temperature

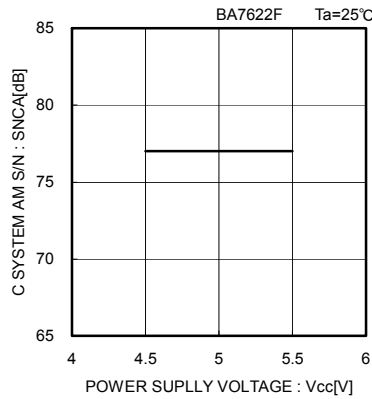

Fig.50 C system AM S/N (bias) vs. Supply voltage

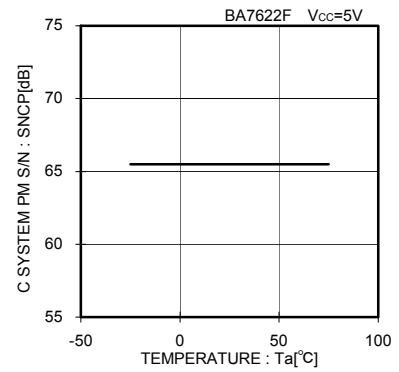

Fig.51 C system PM S/N (clamp) vs. Temperature

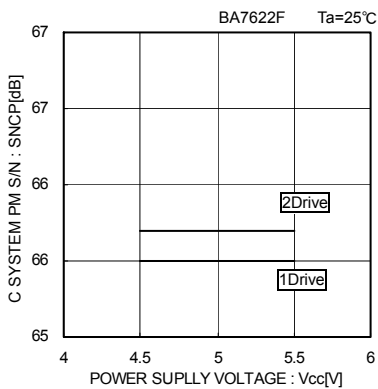

Fig.52 C system PM S/N (clamp) vs. Supply voltage

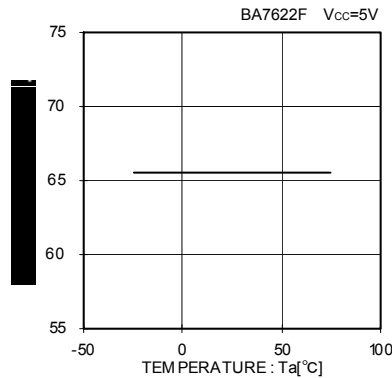

Fig.53 C system PM S/N (bias) vs. Temperature

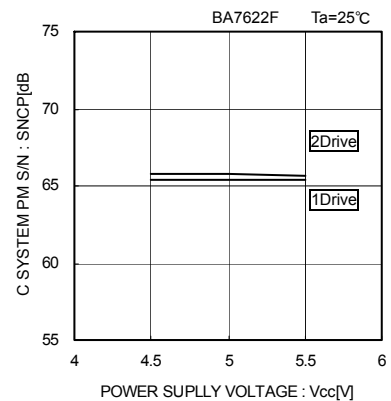

Fig.54 C system PM S/N (bias) vs. Supply voltage

●Reference data (5/5)

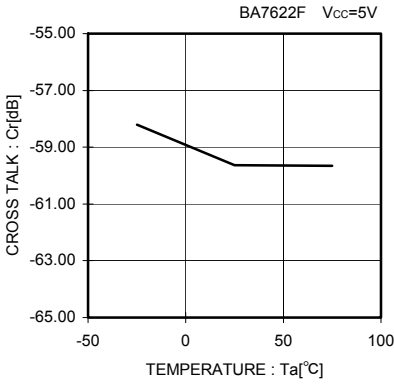

Fig.55 Cross talk vs. Temperature

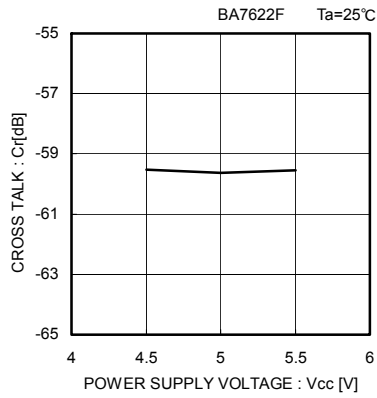

Fig.56 Cross talk vs. Supply voltage

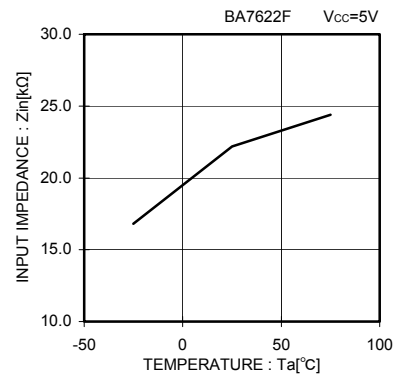

Fig.57 Input impedance vs. Temperature

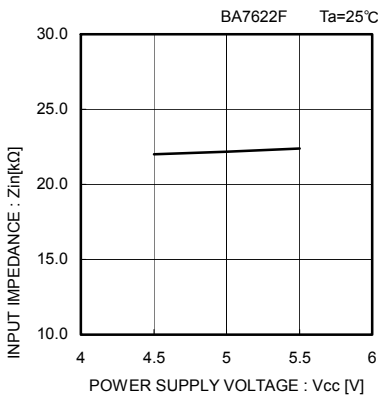

Fig.58 Input impedance vs. Supply voltage

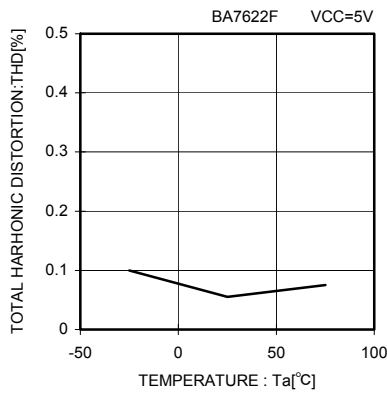

Fig.59 Total harmonic distortion (clamp) vs. Temperature

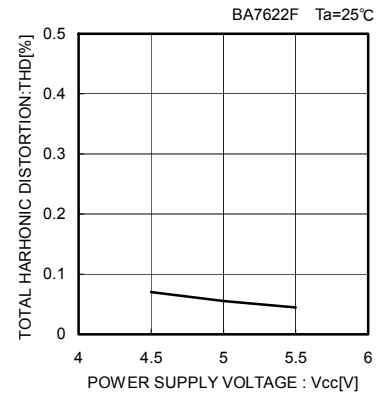

Fig.60 Total harmonic distortion (clamp) vs. Supply voltage

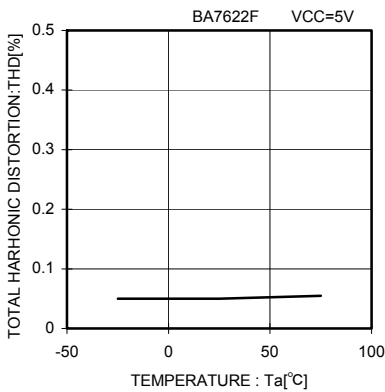

Fig.61 Total harmonic distortion (bias) vs. Temperature

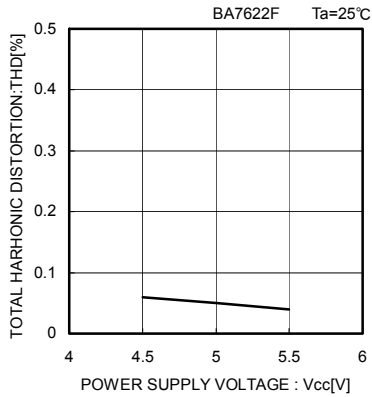

Fig.62 Total harmonic distortion (bias) vs. Supply voltage

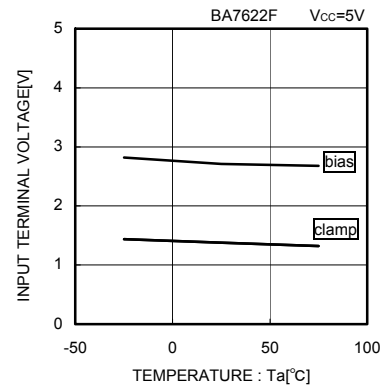

Fig.63 Input terminal voltage vs. Temperature

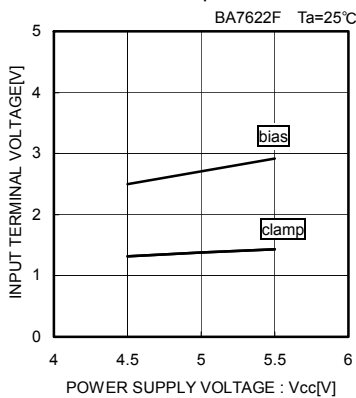

Fig.64 Input terminal voltage vs. Supply voltage

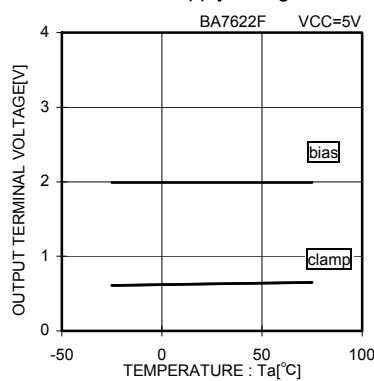

Fig.65 Output terminal voltage vs. Temperature

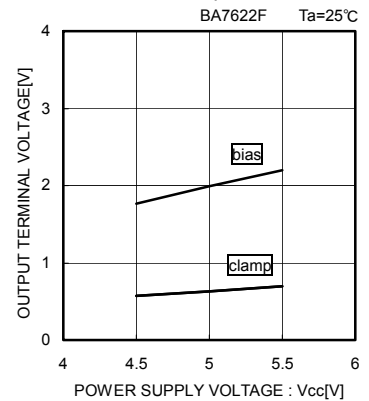
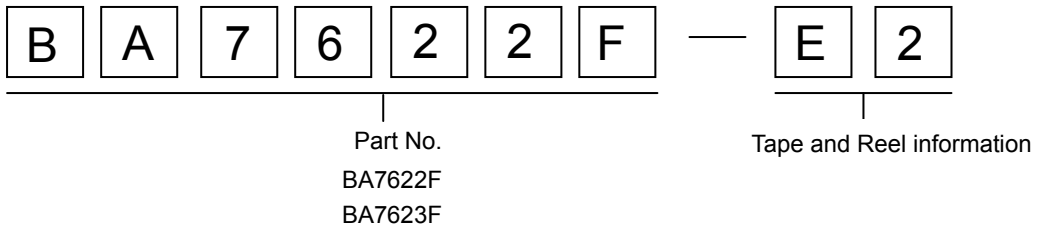
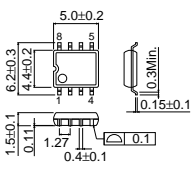
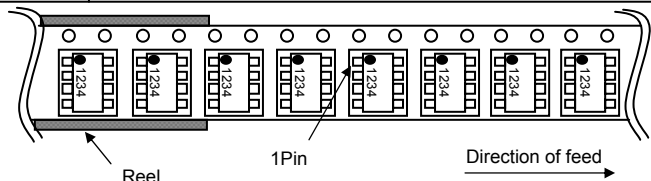

Fig.66 Output terminal voltage vs. Supply voltage

●Selection of order type



**SOP8**

<p>&lt;Dimension&gt;</p>  <p style="text-align: right;">(Unit:mm)</p>	<p>&lt;Tape and Reel information&gt;</p> <table border="1" style="width: 100%; border-collapse: collapse;"> <tr> <td style="width: 20%;">Tape</td> <td>Embossed carrier tape</td> </tr> <tr> <td>Quantity</td> <td>2500pcs</td> </tr> <tr> <td>Direction of feed</td> <td>E2 (Correct direction: 1pin of product should be at the upper left when you hold reel on the left hand, and you pull out the tape on the right hand)</td> </tr> </table>  <p style="text-align: right;">※Orders are available in complete units only.</p>	Tape	Embossed carrier tape	Quantity	2500pcs	Direction of feed	E2 (Correct direction: 1pin of product should be at the upper left when you hold reel on the left hand, and you pull out the tape on the right hand)
Tape	Embossed carrier tape						
Quantity	2500pcs						
Direction of feed	E2 (Correct direction: 1pin of product should be at the upper left when you hold reel on the left hand, and you pull out the tape on the right hand)						



## Notes

No copying or reproduction of this document, in part or in whole, is permitted without the consent of ROHM Co.,Ltd.

The content specified herein is subject to change for improvement without notice.

The content specified herein is for the purpose of introducing ROHM's products (hereinafter "Products"). If you wish to use any such Product, please be sure to refer to the specifications, which can be obtained from ROHM upon request.

Examples of application circuits, circuit constants and any other information contained herein illustrate the standard usage and operations of the Products. The peripheral conditions must be taken into account when designing circuits for mass production.

Great care was taken in ensuring the accuracy of the information specified in this document. However, should you incur any damage arising from any inaccuracy or misprint of such information, ROHM shall bear no responsibility for such damage.

The technical information specified herein is intended only to show the typical functions of and examples of application circuits for the Products. ROHM does not grant you, explicitly or implicitly, any license to use or exercise intellectual property or other rights held by ROHM and other parties. ROHM shall bear no responsibility whatsoever for any dispute arising from the use of such technical information.

The Products specified in this document are intended to be used with general-use electronic equipment or devices (such as audio visual equipment, office-automation equipment, communication devices, electronic appliances and amusement devices).

The Products specified in this document are not designed to be radiation tolerant.

While ROHM always makes efforts to enhance the quality and reliability of its Products, a Product may fail or malfunction for a variety of reasons.

Please be sure to implement in your equipment using the Products safety measures to guard against the possibility of physical injury, fire or any other damage caused in the event of the failure of any Product, such as derating, redundancy, fire control and fail-safe designs. ROHM shall bear no responsibility whatsoever for your use of any Product outside of the prescribed scope or not in accordance with the instruction manual.

The Products are not designed or manufactured to be used with any equipment, device or system which requires an extremely high level of reliability the failure or malfunction of which may result in a direct threat to human life or create a risk of human injury (such as a medical instrument, transportation equipment, aerospace machinery, nuclear-reactor controller, fuel-controller or other safety device). ROHM shall bear no responsibility in any way for use of any of the Products for the above special purposes. If a Product is intended to be used for any such special purpose, please contact a ROHM sales representative before purchasing.

If you intend to export or ship overseas any Product or technology specified herein that may be controlled under the Foreign Exchange and the Foreign Trade Law, you will be required to obtain a license or permit under the Law.



Thank you for your accessing to ROHM product informations.  
More detail product informations and catalogs are available, please contact us.

## ROHM Customer Support System

<http://www.rohm.com/contact/>