

BSS138L, BVSS138L

Power MOSFET 200 mA, 50 V

N-Channel SOT-23

Typical applications are DC-DC converters, power management in portable and battery-powered products such as computers, printers, PCMCIA cards, cellular and cordless telephones.

Features

- Low Threshold Voltage ($V_{GS(th)}$: 0.85 V–1.5 V) Makes it Ideal for Low Voltage Applications
- Miniature SOT-23 Surface Mount Package Saves Board Space
- BVSS Prefix for Automotive and Other Applications Requiring Unique Site and Control Change Requirements; AEC-Q101 Qualified and PPAP Capable
- These Devices are Pb-Free, Halogen Free/BFR Free and are RoHS Compliant

MAXIMUM RATINGS ($T_A = 25^\circ\text{C}$ unless otherwise noted)

Rating	Symbol	Value	Unit
Drain-to-Source Voltage	V_{DSS}	50	Vdc
Gate-to-Source Voltage - Continuous	V_{GS}	± 20	Vdc
Drain Current			mA
- Continuous @ $T_A = 25^\circ\text{C}$	I_D	200	
- Pulsed Drain Current ($t_p \leq 10 \mu\text{s}$)	I_{DM}	800	
Total Power Dissipation @ $T_A = 25^\circ\text{C}$	P_D	225	mW
Operating and Storage Temperature Range	T_J, T_{stg}	- 55 to 150	$^\circ\text{C}$
Thermal Resistance, Junction-to-Ambient	$R_{\theta JA}$	556	$^\circ\text{C/W}$
Maximum Lead Temperature for Soldering Purposes, for 10 seconds	T_L	260	$^\circ\text{C}$

Stresses exceeding those listed in the Maximum Ratings table may damage the device. If any of these limits are exceeded, device functionality should not be assumed, damage may occur and reliability may be affected.



ON Semiconductor®

www.onsemi.com

200 mA, 50 V
 $R_{DS(on)} = 3.5 \Omega$

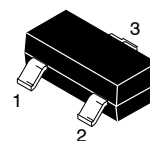
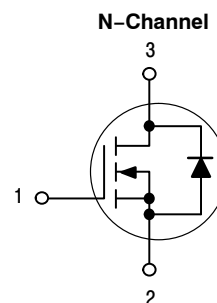

SOT-23
CASE 318
STYLE 21

MARKING DIAGRAM

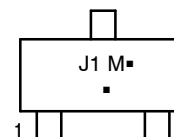

J1 = Device Code
M = Date Code*
▪ = Pb-Free Package

(Note: Microdot may be in either location)

*Date Code orientation and/or overbar may vary depending upon manufacturing location.

ORDERING INFORMATION

Device	Package	Shipping†
BSS138LT1G, BVSS138LT1G	SOT-23 (Pb-Free)	3,000 / Tape & Reel
BSS138LT7G	SOT-23 (Pb-Free)	3,500 / Tape & Reel
BSS138LT3G, BVSS138LT3G	SOT-23 (Pb-Free)	10,000 / Tape & Reel

†For information on tape and reel specifications, including part orientation and tape sizes, please refer to our Tape and Reel Packaging Specifications Brochure, BRD8011/D.

BSS138L, BVSS138L

ELECTRICAL CHARACTERISTICS (T_A = 25°C unless otherwise noted)

Characteristic	Symbol	Min	Typ	Max	Unit
----------------	--------	-----	-----	-----	------

OFF CHARACTERISTICS

Drain-to-Source Breakdown Voltage (V _{GS} = 0 Vdc, I _D = 250 μAdc)	V _{(BR)DSS}	50	–	–	Vdc
Zero Gate Voltage Drain Current (V _{DS} = 25 Vdc, V _{GS} = 0 Vdc, 25°C) (V _{DS} = 50 Vdc, V _{GS} = 0 Vdc, 25°C) (V _{DS} = 50 Vdc, V _{GS} = 0 Vdc, 150°C)	I _{DSS}	–	–	0.1 0.5 5.0	μAdc
Gate-Source Leakage Current (V _{GS} = ± 20 Vdc, V _{DS} = 0 Vdc)	I _{GSS}	–	–	±0.1	μAdc

ON CHARACTERISTICS (Note 1)

Gate-Source Threshold Voltage (V _{DS} = V _{GS} , I _D = 1.0 mAdc)	V _{GS(th)}	0.85	–	1.5	Vdc
Static Drain-to-Source On-Resistance (V _{GS} = 2.75 Vdc, I _D < 200 mAdc, T _A = –40°C to +85°C) (V _{GS} = 5.0 Vdc, I _D = 200 mAdc)	r _{DS(on)}	–	5.6	10	Ω
Forward Transconductance (V _{DS} = 25 Vdc, I _D = 200 mAdc, f = 1.0 kHz)	g _{fs}	100	–	–	mmhos

DYNAMIC CHARACTERISTICS

Input Capacitance	(V _{DS} = 25 Vdc, V _{GS} = 0, f = 1 MHz)	C _{iss}	–	40	50	pF
Output Capacitance	(V _{DS} = 25 Vdc, V _{GS} = 0, f = 1 MHz)	C _{oss}	–	12	25	
Transfer Capacitance	(V _{DG} = 25 Vdc, V _{GS} = 0, f = 1 MHz)	C _{rss}	–	3.5	5.0	

SWITCHING CHARACTERISTICS (Note 2)

Turn-On Delay Time	(V _{DD} = 30 Vdc, I _D = 0.2 Adc,)	t _{d(on)}	–	–	20	ns
Turn-Off Delay Time		t _{d(off)}	–	–	20	

Product parametric performance is indicated in the Electrical Characteristics for the listed test conditions, unless otherwise noted. Product performance may not be indicated by the Electrical Characteristics if operated under different conditions.

1. Pulse Test: Pulse Width ≤ 300 μs, Duty Cycle ≤ 2%.
2. Switching characteristics are independent of operating junction temperature.

TYPICAL ELECTRICAL CHARACTERISTICS

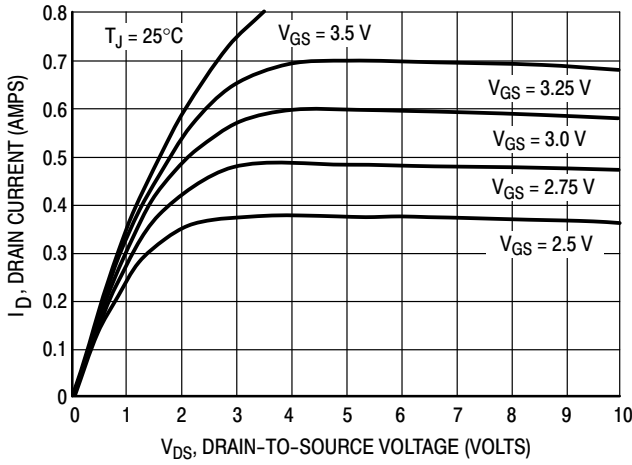

Figure 1. On-Region Characteristics

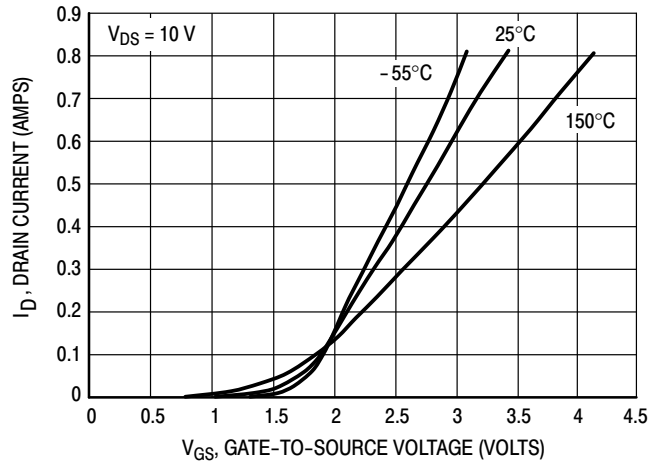

Figure 2. Transfer Characteristics

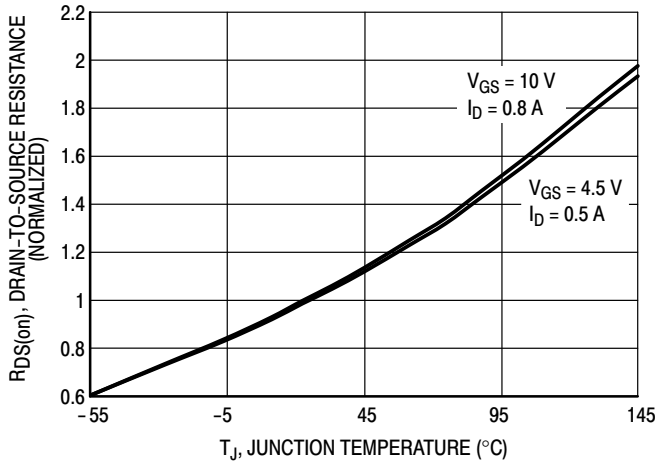

Figure 3. On-Resistance Variation with Temperature

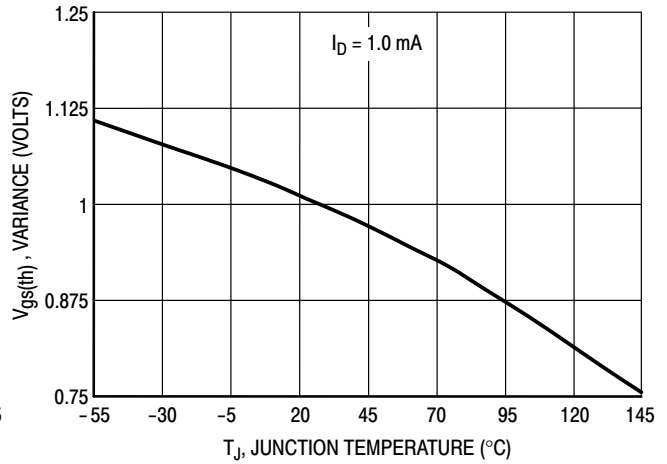

Figure 4. Threshold Voltage Variation with Temperature

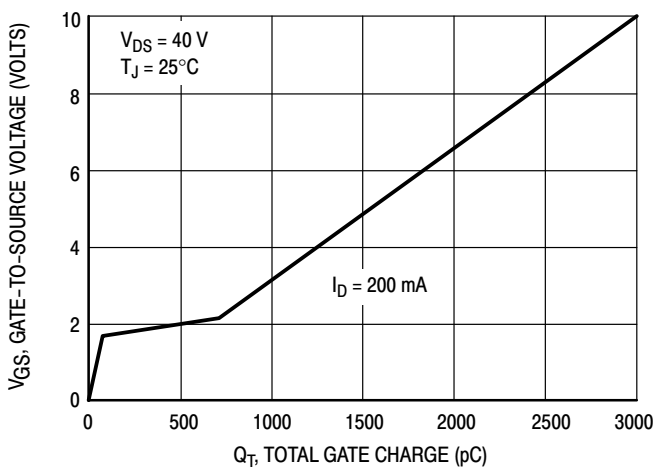

Figure 5. Gate Charge

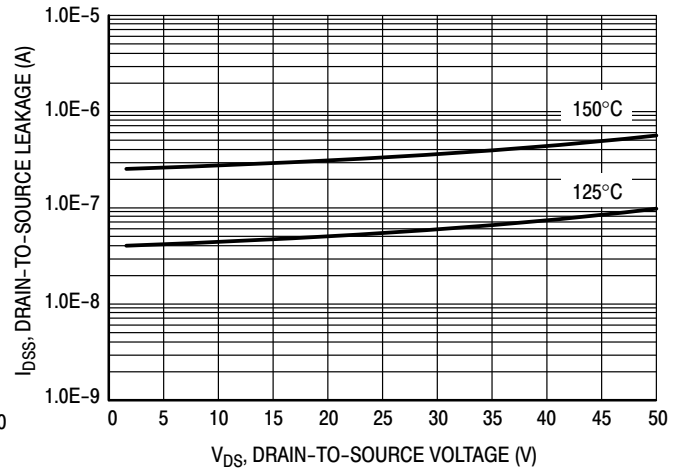

Figure 6. IDSS

BSS138L, BVSS138L

TYPICAL ELECTRICAL CHARACTERISTICS

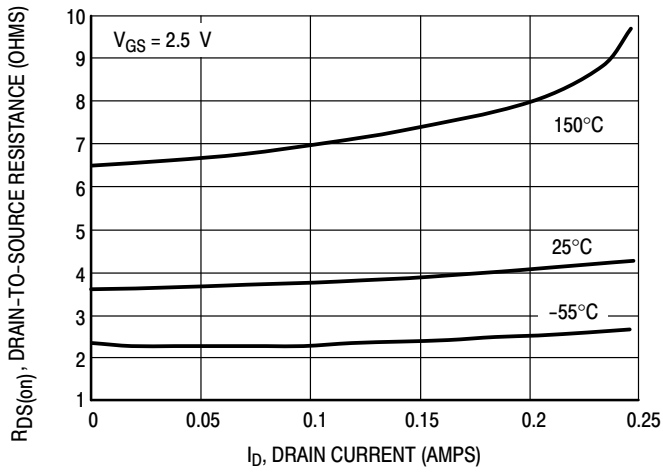

Figure 7. On-Resistance versus Drain Current

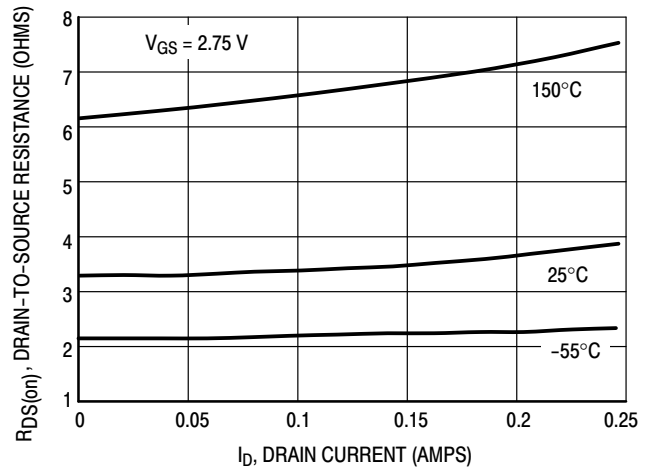

Figure 8. On-Resistance versus Drain Current

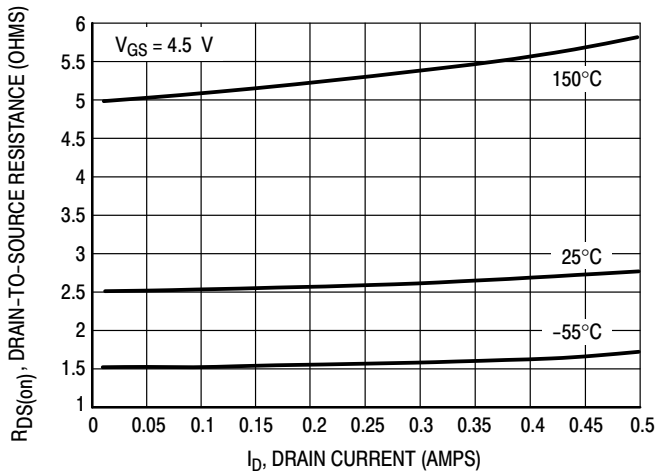

Figure 9. On-Resistance versus Drain Current

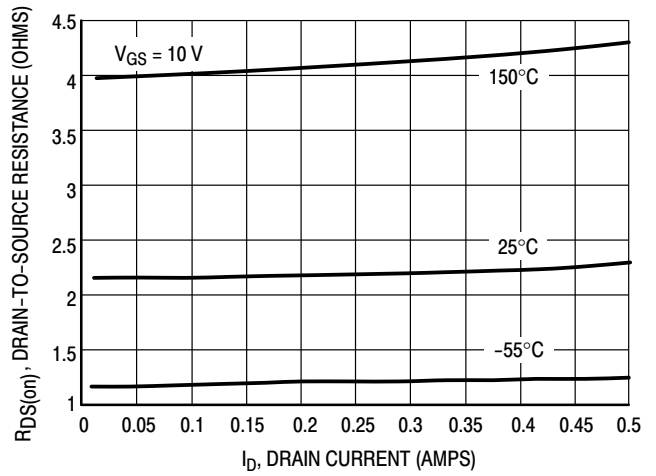

Figure 10. On-Resistance versus Drain Current

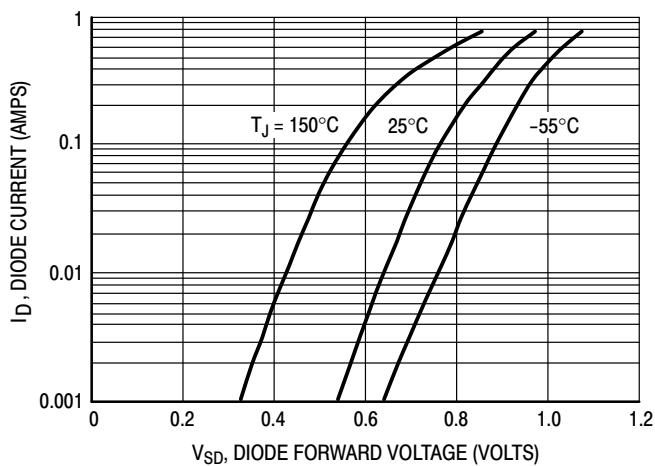

Figure 11. Body Diode Forward Voltage

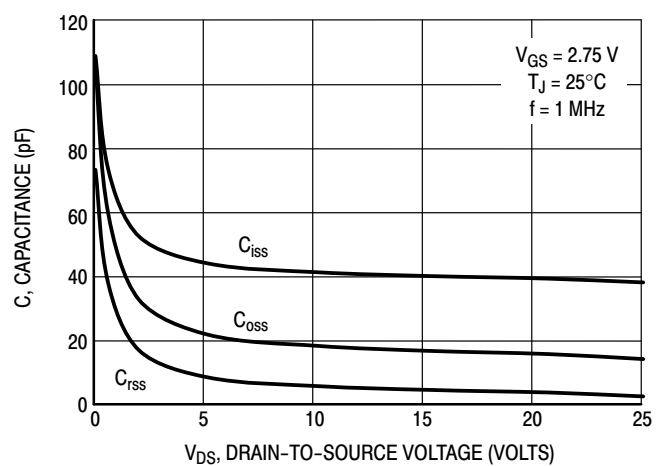

Figure 12. Capacitance

BSS138L, BVSS138L

TYPICAL ELECTRICAL CHARACTERISTICS

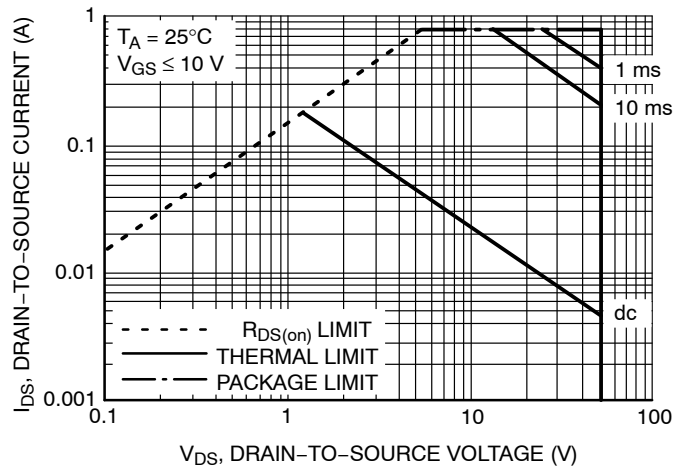

Figure 13. Safe Operating Area

MECHANICAL CASE OUTLINE PACKAGE DIMENSIONS



SOT-23 (TO-236)
CASE 318
ISSUE AT

DATE 01 MAR 2023

SCALE 4:1

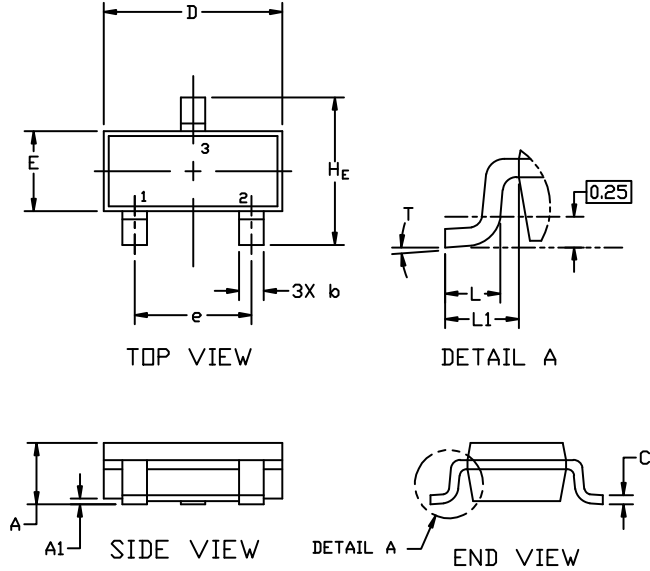

NOTES:

1. DIMENSIONING AND TOLERANCING PER ASME Y14.5M,1994.
2. CONTROLLING DIMENSION: MILLIMETERS
3. MAXIMUM LEAD THICKNESS INCLUDES LEAD FINISH. MINIMUM LEAD THICKNESS IS THE MINIMUM THICKNESS OF THE BASE MATERIAL.
4. DIMENSIONS D AND E DO NOT INCLUDE MOLD FLASH, PROTRUSIONS, OR GATE BURRS.

DIM	MILLIMETERS			INCHES		
	MIN.	NOM.	MAX.	MIN.	NOM.	MAX.
A	0.89	1.00	1.11	0.035	0.039	0.044
A1	0.01	0.06	0.10	0.000	0.002	0.004
b	0.37	0.44	0.50	0.015	0.017	0.020
c	0.08	0.14	0.20	0.003	0.006	0.008
D	2.80	2.90	3.04	0.110	0.114	0.120
E	1.20	1.30	1.40	0.047	0.051	0.055
e	1.78	1.90	2.04	0.070	0.075	0.080
L	0.30	0.43	0.55	0.012	0.017	0.022
L1	0.35	0.54	0.69	0.014	0.021	0.027
H _E	2.10	2.40	2.64	0.083	0.094	0.104
T	0°	---	10°	0°	---	10°

GENERIC MARKING DIAGRAM*



- XXX = Specific Device Code
- M = Date Code
- = Pb-Free Package

*This information is generic. Please refer to device data sheet for actual part marking. Pb-Free indicator, "G" or microdot "▪", may or may not be present. Some products may not follow the Generic Marking.



RECOMMENDED MOUNTING FOOTPRINT

* For additional information on our Pb-Free strategy and soldering details, please download the ON Semiconductor Soldering and Mounting Techniques Reference Manual, SOLDERRM/D.

STYLES ON PAGE 2

DOCUMENT NUMBER:	98ASB42226B	Electronic versions are uncontrolled except when accessed directly from the Document Repository. Printed versions are uncontrolled except when stamped "CONTROLLED COPY" in red.
DESCRIPTION:	SOT-23 (TO-236)	PAGE 1 OF 2

onsemi and ONSEMI are trademarks of Semiconductor Components Industries, LLC dba onsemi or its subsidiaries in the United States and/or other countries. onsemi reserves the right to make changes without further notice to any products herein. onsemi makes no warranty, representation or guarantee regarding the suitability of its products for any particular purpose, nor does onsemi assume any liability arising out of the application or use of any product or circuit, and specifically disclaims any and all liability, including without limitation special, consequential or incidental damages. onsemi does not convey any license under its patent rights nor the rights of others.

MECHANICAL CASE OUTLINE
PACKAGE DIMENSIONS



SOT-23 (TO-236)
CASE 318
ISSUE AT

DATE 01 MAR 2023

STYLE 1 THRU 5:
 CANCELLED

STYLE 6:
 PIN 1. BASE
 2. EMITTER
 3. COLLECTOR

STYLE 7:
 PIN 1. EMITTER
 2. BASE
 3. COLLECTOR

STYLE 8:
 PIN 1. ANODE
 2. NO CONNECTION
 3. CATHODE

STYLE 9:
 PIN 1. ANODE
 2. ANODE
 3. CATHODE

STYLE 10:
 PIN 1. DRAIN
 2. SOURCE
 3. GATE

STYLE 11:
 PIN 1. ANODE
 2. CATHODE
 3. CATHODE-ANODE

STYLE 12:
 PIN 1. CATHODE
 2. CATHODE
 3. ANODE

STYLE 13:
 PIN 1. SOURCE
 2. DRAIN
 3. GATE

STYLE 14:
 PIN 1. CATHODE
 2. GATE
 3. ANODE

STYLE 15:
 PIN 1. GATE
 2. CATHODE
 3. ANODE

STYLE 16:
 PIN 1. ANODE
 2. CATHODE
 3. CATHODE

STYLE 17:
 PIN 1. NO CONNECTION
 2. ANODE
 3. CATHODE

STYLE 18:
 PIN 1. NO CONNECTION
 2. CATHODE
 3. ANODE

STYLE 19:
 PIN 1. CATHODE
 2. ANODE
 3. CATHODE-ANODE

STYLE 20:
 PIN 1. CATHODE
 2. ANODE
 3. GATE

STYLE 21:
 PIN 1. GATE
 2. SOURCE
 3. DRAIN

STYLE 22:
 PIN 1. RETURN
 2. OUTPUT
 3. INPUT

STYLE 23:
 PIN 1. ANODE
 2. ANODE
 3. CATHODE

STYLE 24:
 PIN 1. GATE
 2. DRAIN
 3. SOURCE

STYLE 25:
 PIN 1. ANODE
 2. CATHODE
 3. GATE

STYLE 26:
 PIN 1. CATHODE
 2. ANODE
 3. NO CONNECTION

STYLE 27:
 PIN 1. CATHODE
 2. CATHODE
 3. CATHODE

STYLE 28:
 PIN 1. ANODE
 2. ANODE
 3. ANODE

DOCUMENT NUMBER:	98ASB42226B	Electronic versions are uncontrolled except when accessed directly from the Document Repository. Printed versions are uncontrolled except when stamped "CONTROLLED COPY" in red.
DESCRIPTION:	SOT-23 (TO-236)	PAGE 2 OF 2

onsemi and **ONSEMI** are trademarks of Semiconductor Components Industries, LLC dba **onsemi** or its subsidiaries in the United States and/or other countries. **onsemi** reserves the right to make changes without further notice to any products herein. **onsemi** makes no warranty, representation or guarantee regarding the suitability of its products for any particular purpose, nor does **onsemi** assume any liability arising out of the application or use of any product or circuit, and specifically disclaims any and all liability, including without limitation special, consequential or incidental damages. **onsemi** does not convey any license under its patent rights nor the rights of others.

onsemi, **Onsemi**, and other names, marks, and brands are registered and/or common law trademarks of Semiconductor Components Industries, LLC dba "**onsemi**" or its affiliates and/or subsidiaries in the United States and/or other countries. **onsemi** owns the rights to a number of patents, trademarks, copyrights, trade secrets, and other intellectual property. A listing of **onsemi**'s product/patent coverage may be accessed at www.onsemi.com/site/pdf/Patent-Marking.pdf. **onsemi** reserves the right to make changes at any time to any products or information herein, without notice. The information herein is provided "as-is" and **onsemi** makes no warranty, representation or guarantee regarding the accuracy of the information, product features, availability, functionality, or suitability of its products for any particular purpose, nor does **onsemi** assume any liability arising out of the application or use of any product or circuit, and specifically disclaims any and all liability, including without limitation special, consequential or incidental damages. Buyer is responsible for its products and applications using **onsemi** products, including compliance with all laws, regulations and safety requirements or standards, regardless of any support or applications information provided by **onsemi**. "Typical" parameters which may be provided in **onsemi** data sheets and/or specifications can and do vary in different applications and actual performance may vary over time. All operating parameters, including "Typicals" must be validated for each customer application by customer's technical experts. **onsemi** does not convey any license under any of its intellectual property rights nor the rights of others. **onsemi** products are not designed, intended, or authorized for use as a critical component in life support systems or any FDA Class 3 medical devices or medical devices with a same or similar classification in a foreign jurisdiction or any devices intended for implantation in the human body. Should Buyer purchase or use **onsemi** products for any such unintended or unauthorized application, Buyer shall indemnify and hold **onsemi** and its officers, employees, subsidiaries, affiliates, and distributors harmless against all claims, costs, damages, and expenses, and reasonable attorney fees arising out of, directly or indirectly, any claim of personal injury or death associated with such unintended or unauthorized use, even if such claim alleges that **onsemi** was negligent regarding the design or manufacture of the part. **onsemi** is an Equal Opportunity/Affirmative Action Employer. This literature is subject to all applicable copyright laws and is not for resale in any manner.

ADDITIONAL INFORMATION

TECHNICAL PUBLICATIONS:

Technical Library: www.onsemi.com/design/resources/technical-documentation
onsemi Website: www.onsemi.com

ONLINE SUPPORT: www.onsemi.com/support

For additional information, please contact your local Sales Representative at www.onsemi.com/support/sales